

Programmable AC Power Supply

Series IT7300 User's Manual

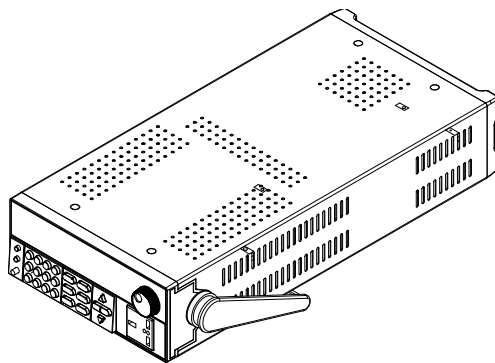

Model:
IT7321/IT7322/IT7322H/IT7324/IT7324H/IT7326/
IT7326H/IT7322T/IT7322HT/IT7324T/IT7324HT/
IT7326T/IT7326HT
Version: V4.7

Statement

© Itech Electronic, Co., Ltd. 2022

No part of this manual may be reproduced in any form or by any means (including electronic storage and retrieval or translation into a foreign language) without prior permission and written consent from Itech Electronic, Co., Ltd. as governed by international copyright laws.

Manual Article No.

IT7300-402210

Revision

Revision 4, published on

August 16, 2022

Itech Electronic, Co., Ltd.

Trademark Statement

Pentium is a registered trademark of Intel Corporation in the United States.

Microsoft, Visual Studio, Windows and MS Windows are trademarks of Microsoft Corporation in the United States and/or other countries/regions.

Guarantee

The materials contained in this document are provided “as is”, and is subject to change, without prior notice, in future editions. Further, to the maximum extent permitted by applicable laws, ITECH disclaims all warranties, either express or implied, with regard to this manual and any information contained herein, including but not limited to the implied warranties of merchantability and fitness for a particular purpose. ITECH shall not be held liable for errors or for incidental or indirect damages in connection with the furnishing, use or application of this document or of any information contained herein. Should ITECH and the user enter into a separate written agreement with warranty terms covering the materials in this document that conflict with these terms, the warranty terms in the separate agreement shall prevail.

Technology license

Hardware and/or software in this document cannot be provided without a license and can only be used or copied according to the license.

Restricted permission statement

Restricted permissions of the U.S. government. Permissions for software and technical data which are authorized to the U.S. Government only include those for custom provision to end users. ITECH follows FAR 12.211 (technical data), 12.212 (computer software), DFARS 252.227-7015 (technical data--commercial products) for national defense and DFARS 227.7202-3 (permissions for commercial computer software or computer software documents) while providing the customized business licenses of software and technical data.

Safety Statement

CAUTION

“Caution” signs indicate danger. It is required to pay attention to the contents of these signs during implementation of operations.

The damage to the product or loss of important data may be caused in case of improper operation steps or failure to follow operation steps. Do not continue to implement any improper operation indicated in “Caution” signs when the specified conditions are not fully understood or these conditions are not satisfied.

WARNING

“Warning” indicates danger. It is required to pay attention to the contents of these signs during implementation of operation steps. Personal casualties may be caused in case of improper operation steps or failure to follow these operation steps. Do not continue to implement any improper operation indicated in “Warning” signs when the specified conditions are not fully understood or these conditions are not satisfied.



NOTE

“Instructions” indicates operation instructions. It is required to refer to the contents of these signs during operation steps. These signs are used for providing tips or supplementary information for operators.

Certification and Quality Assurance

IT7300 series programmable AC power supply fully meet all of the technical specification in the manual.

Warranty Service













ITECH Company will provide one-year warranty services for the product materials and manufacturing (excluding the following limitations).



- When warranty service or repair is needed, please send the product to the service unit specified by ITECH Company.
- When the product is sent to ITECH Company for warranty service, the customer must pay the one-way freight to the maintenance department of ITECH, and ITECH will be responsible for return freight.
- If the product is sent to ITECH for warranty service from other countries, the customer will be responsible for all the freight, duties and other taxes.

Limitation of Warranty

- Warranty service does not apply to the damage caused in the following circumstances:
- Damage resulting from customer-wired circuits or customer-supplied parts or accessories;
- Product which has been modified or repaired by the customer;
- Damage caused by the circuit installed by the customer or damage caused by operation of the product in non-specified environment;
- The product model or serial number is altered, deleted, removed or made illegible by customer;
- Damage caused by accidents, including but not limited to lightning, water, fire, abuse or negligence.

Safety Signs

	Direct current		ON (power)
	Alternating current		OFF (power)
	Both direct and alternating current		Power-on state
	Protective earth (ground) terminal		Power-off state
	Earth (ground) terminal		Reference terminal
	Caution		Positive terminal

	Warning (refer to this manual for specific Warning or Caution information)	—	Negative terminal
	A chassis terminal	-	-

Safety Precautions

The following safety precautions must be observed during all phases of operation of this instrument. Failure to comply with these precautions or specific warnings elsewhere in this manual will constitute a default under safety standards of design, manufacture and intended use of the instrument. ITECH assumes no liability for the customer's failure to comply with these precautions.

WARNING

- Do not use the instrument if it is damaged. Before operation, check the casing to see whether it cracks. Do not operate the instrument in the presence of inflammable gasses, vapors or dusts.
- The power supply is provided with a power line during delivery and should be connected to junction box. Before operation, be sure that the power supply is well grounded. Make sure to use the power cord supplied by ITECH.
- Check all marks on the instrument before connecting the instrument to power supply.
- Use electric wires of appropriate load. All loading wires should be capable of bearing maximum short-circuit of electronic load without overheating. If there are multiple loads, each pair of the load power cord must be carry out the full rated short-circuit output current of the power securely.
- Ensure the voltage fluctuation of mains supply is less than 10% of the working voltage range in order to reduce risks of fire and electric shock.
- Do not install alternative parts on the instrument or perform any unauthorized modification.
- Do not use the instrument if the detachable cover is removed or loosen.
- To prevent the possibility of accidental injuries, be sure to use the power adapter supplied by the manufacturer only.
- We do not accept responsibility for any direct or indirect financial damage or loss of profit that might occur when using the instrument.
- This instrument is used for industrial purposes, do not apply this product to IT power supply system.
- Never use the instrument with a life-support system or any other equipment subject to safety requirements.

CAUTION

- Failure to use the instrument as directed by the manufacturer may render its protective features void.
- Always clean the casing with a dry cloth. Do not clean the internals.

- **Make sure the vent hole is always unblocked.**

Environmental Conditions

The IT7300 series power supply can only be used indoors or in low condensation areas. The following table shows general environmental requirements for this instrument.



Environmental conditions	Requirement
Operating temperature	0°C - 40°C
Operating humidity	20% - 80%(non condensing)
Storage temperature	-10°C - 70 °C
Altitude	Operating up to 2,000 meters
Installation category	II
Pollution degree	Pollution degree 2



NOTE

In order to ensure the accuracy of measurement, it is recommended to operate the instrument half an hour after start-up.

Regulation Tag

	The CE tag shows that the product complies with the provisions of all relevant European laws (if the year is shown, it indicates that the year when the design is approved).
	This instrument complies with the WEEE directive (2002/96/EC) tag requirements. This attached product tag shows that the electrical/electronic product cannot be discarded in household waste.
	This symbol indicates that no danger will happen or toxic substances will not leak or cause damage in normal use within the specified period. The service life of the product is 10 years. The product can be used safely within the environmental protection period; otherwise, the product should be put into the recycling system.

Waste Electrical and Electronic Equipment (WEEE) Directive



Waste electrical and electronic equipment (WEEE) directive, 2002/96/EC
 The product complies with tag requirements of the WEEE directive (2002/96/EC). This tag indicates that the electronic equipment cannot be disposed of as ordinary household waste.

Product Category

According to the equipment classification in Annex I of the WEEE directive, this instrument belongs to the "Monitoring" product.

If you want to return the unnecessary instrument, please contact the nearest sales office of ITECH.

Compliance Information

Complies with the essential requirements of the following applicable European Directives, and carries the CE marking accordingly:

- Electromagnetic Compatibility (EMC) Directive 2014/30/EU
- Low-Voltage Directive (Safety) 2014/35/EU

Conforms with the following product standards:

EMC Standard

IEC 61326-1:2012/ EN 61326-1:2013 ¹²³

Reference Standards

CISPR 11:2009+A1:2010/ EN 55011:2009+A1:2010 (Group 1, Class A)

IEC 61000-4-2:2008/ EN 61000-4-2:2009

IEC 61000-4-3:2006+A1:2007+A2:2010/ EN 61000-4-3:2006+A1:2008+A2:2010

IEC 61000-4-4:2004+A1:2010/ EN 61000-4-4:2004+A1:2010

IEC 61000-4-5:2005/ EN 61000-4-5:2006

IEC 61000-4-6:2008/ EN 61000-4-6:2009

IEC 61000-4-11:2004/ EN 61000-4-11:2004

1. The product is intended for use in non-residential/non-domestic environments. Use of the product in residential/domestic environments may cause electromagnetic interference.
2. Connection of the instrument to a test object may produce radiations beyond the specified limit.
3. Use high-performance shielded interface cable to ensure conformity with the EMC standards listed above.

Safety Standard

IEC 61010-1:2010/ EN 61010-1:2010

Content

Certification and Quality Assurance	i
Warranty Service	i
Limitation of Warranty.....	i
Safety Signs.....	i
Safety Precautions	ii
Environmental Conditions.....	iii
Regulation Tag.....	iii
Waste Electrical and Electronic Equipment (WEEE) Directive.....	iii
Compliance Information.....	v
Chapter1 Acceptance and Installation	1
1.1 Confirm Package Contents.....	1
1.2 Installation Position.....	1
1.3 Installation of Power Cord	15
1.4 Connecting Test Cables (Optional).....	16
Chapter2 Quick Start.....	20
2.1 Brief Introduction	20
2.2 Introduction of Front Panel	22
2.3 Key Introduction.....	25
2.4 VFD Indicator Description.....	26
2.5 Introduction of Rear Panel.....	26
2.6 Power-on Selftest	28
2.7 Voltage Output Checkout.....	31
Chapter3 Function and Features	32
3.1 Switching of Local/Remote Operation Modes	32
3.2 Voltage Setup	32
3.3 Frequency Setup	33
3.4 Phase Angle Setup	33
3.5 Output On/Off Operation	33
3.6 Switch the VFD Display Items	33
3.7 Save and Recall Operation.....	34
3.8 Trigger Operation.....	34
3.9 Menu Operation	35
3.10 Function Operation	40
3.11 Output Range.....	47
3.12 Key Lock.....	48
3.13 BNC	48
3.14 3ø-Setup	49
Chapter4 Specification	52
4.1 Specification	52
4.2 Supplemental Characteristics.....	72
Chapter5 Remote Control.....	73
5.1 RS232 Interface.....	73
5.2 USB Interface	74
5.3 LAN Interface.....	75
5.4 GPIB Interface (IT7300(G) series only).....	75
Appendix	76
Specifications of Red and Black Test Lines.....	76

Chapter1 Acceptance and Installation

Power supply is a high level safety equipment, there is a protected ground terminal. Before Installation or operation, please read the safety signs and instructions in this manual.

1.1 Confirm Package Contents

Open the package and check the articles within package box before operation. In case of any non-conformity, missing or appearance wearing, please contact ITECH immediately.

The package box should comprise:

Device name	Quantity	Model	Remarks
Programmable AC Power Supply	x1	IT7300 series	IT7300 series include: IT7321/IT7322/IT7322H/IT7324/IT7324H/IT7326/IT7326H/IT7322T/IT7322HT/IT7324T/IT7324HT/IT7326T/IT7326HT
Power Cord	x1	-	Different types of instruments are equipped with different power cables. For detailed specifications, refer to 1.3 Installation of power cord.
USB cable	x1	-	-
Factory alignment report	x1	-	Test report before delivery



NOTE

After confirming that package contents are consistent and correct, please appropriately keep package box and related contents. The package requirements should be met when the instrument is returned to factory for repair.

1.2 Installation Position

The instrument should be installed at well-ventilated and rational-sized space. Please select appropriate space for installation based on the power supply size

Model IT7321

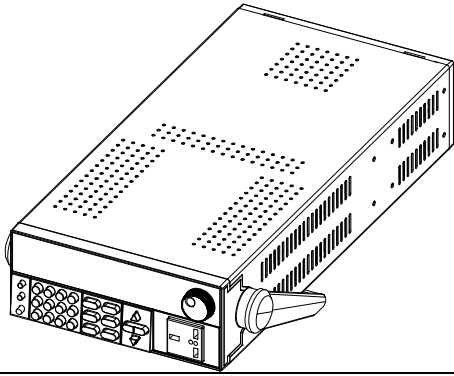

Detailed dimensional drawings

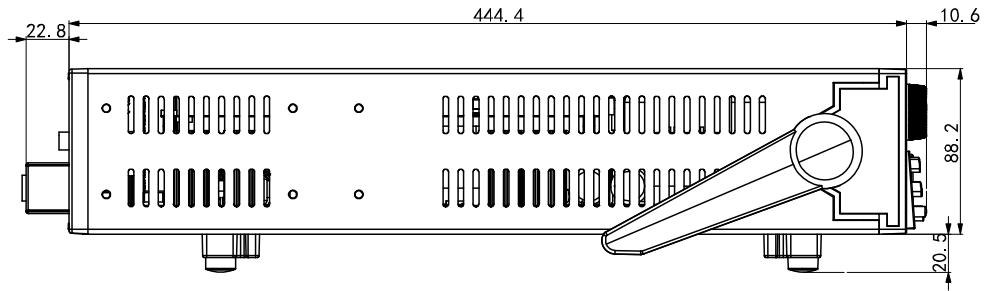
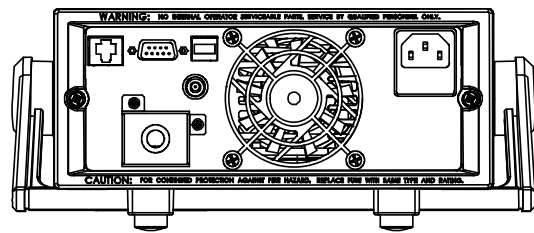
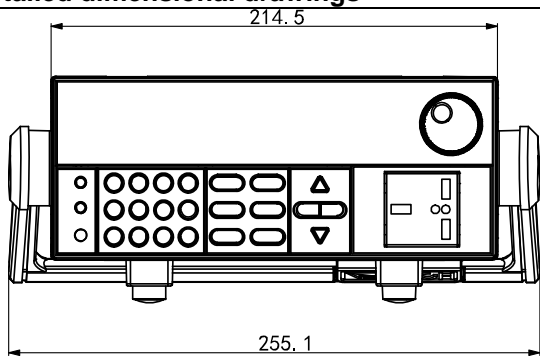

Model IT7322/IT7324

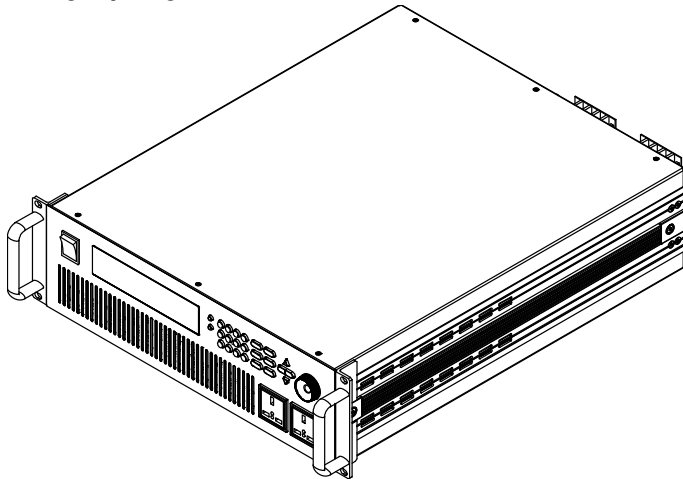

Detailed dimensional drawings

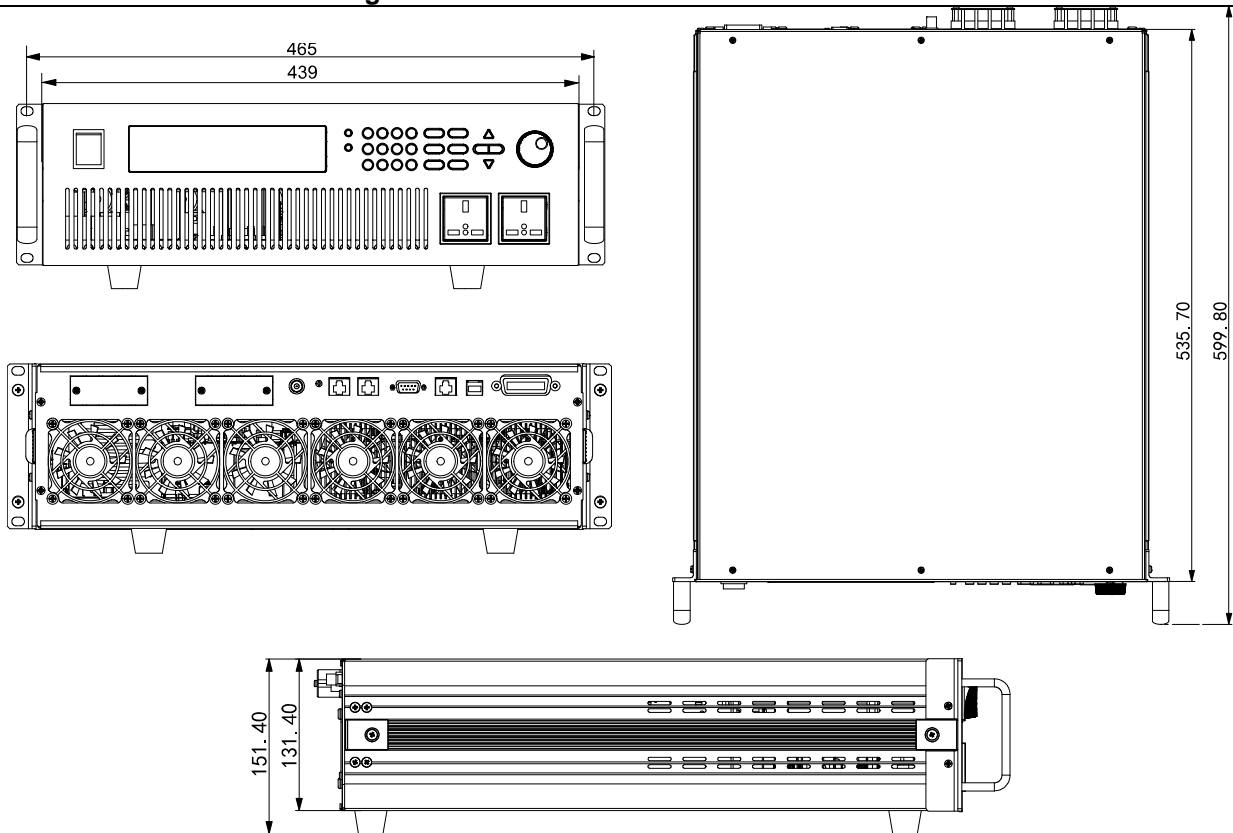

Model IT7322H/IT7324H

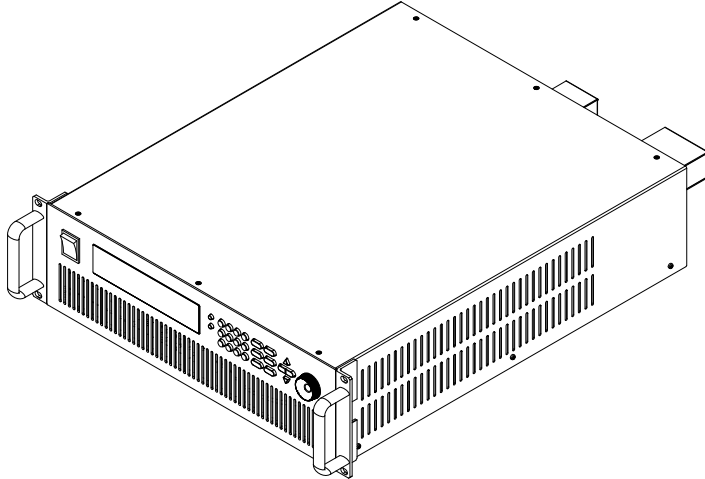

Detailed dimensional drawings

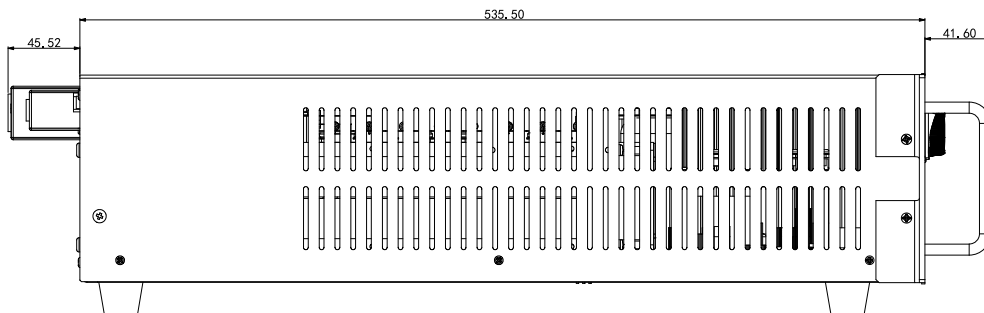
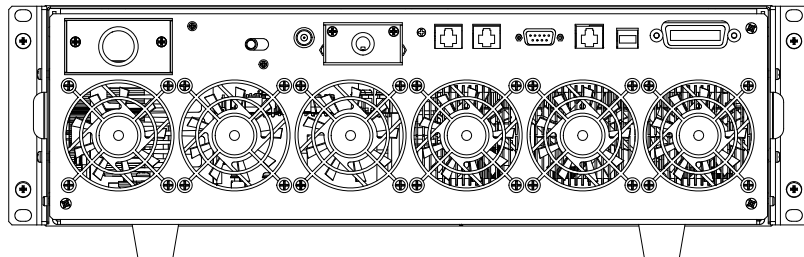
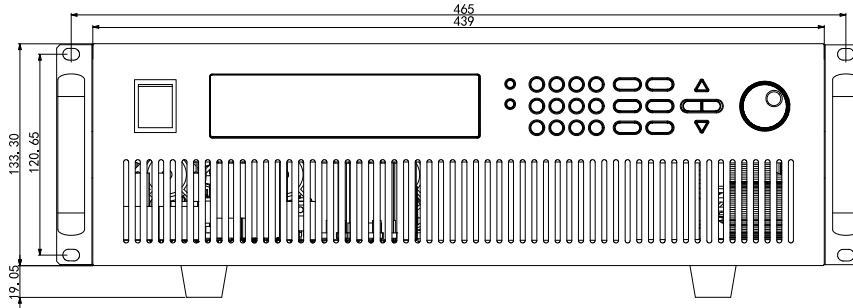

Model IT7326

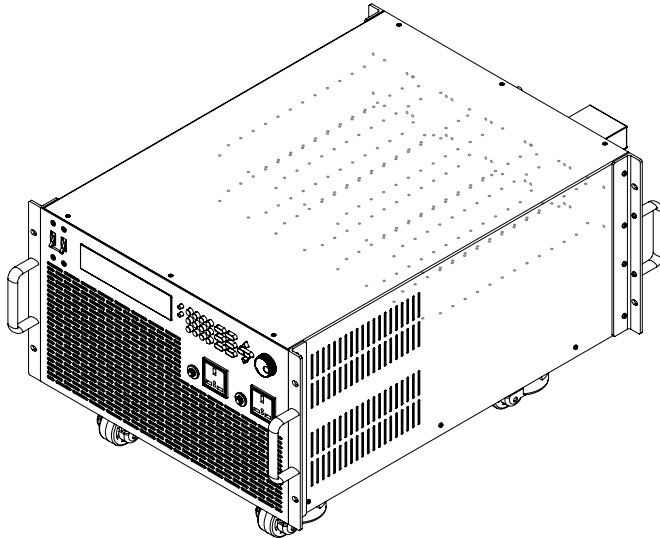

Detailed dimensional drawings

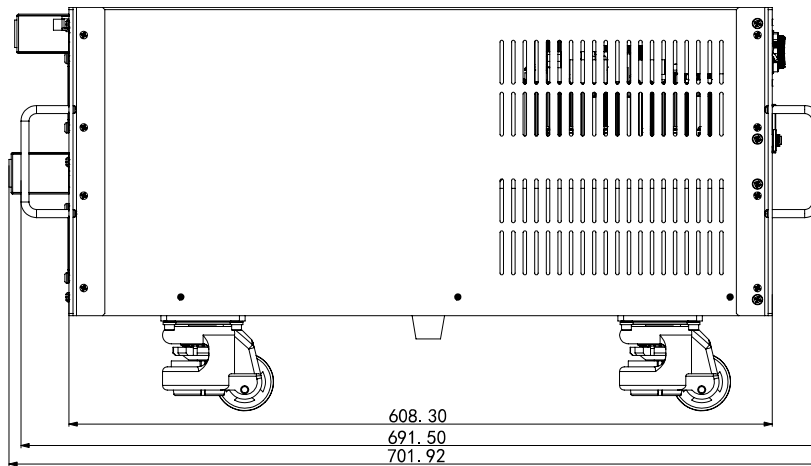
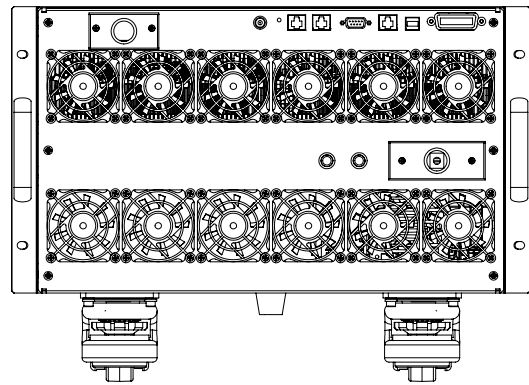
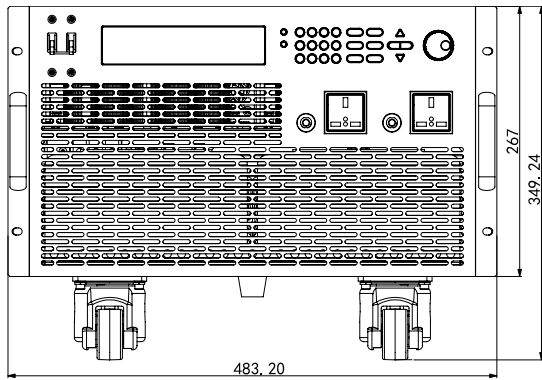

Model IT7326H

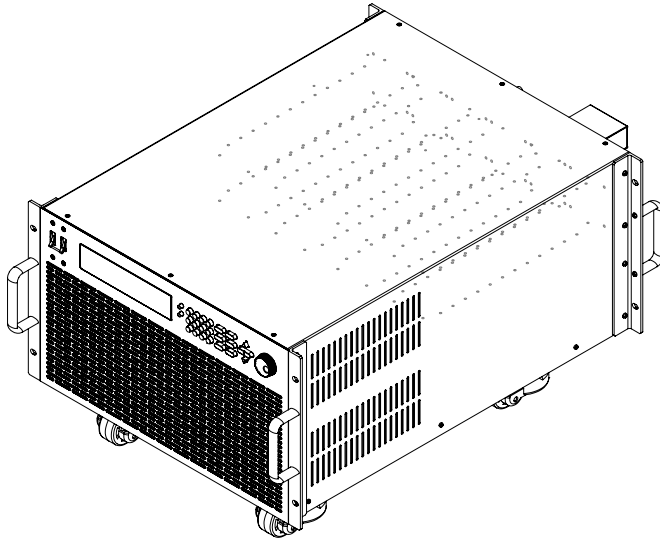

Detailed dimensional drawings

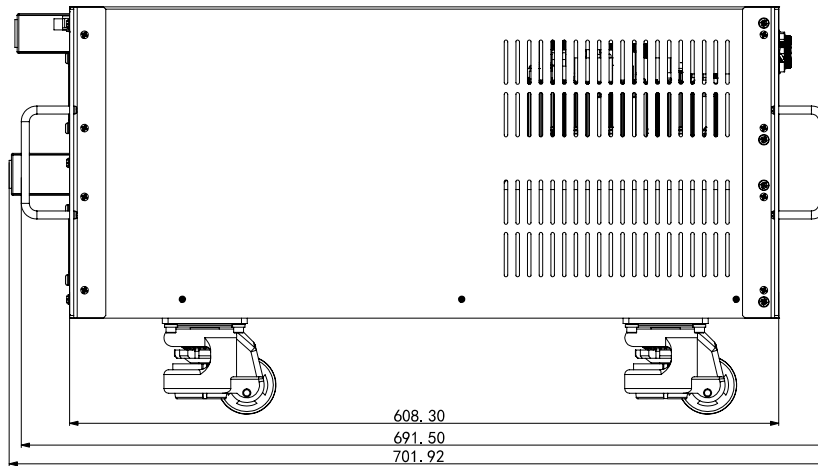
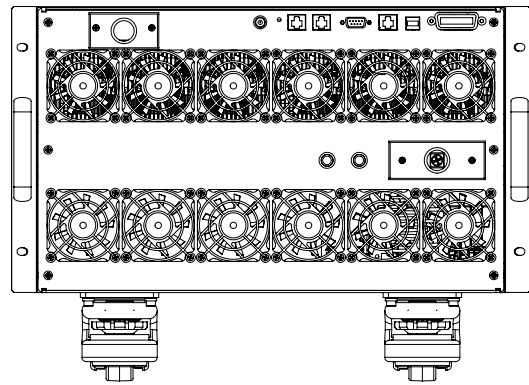
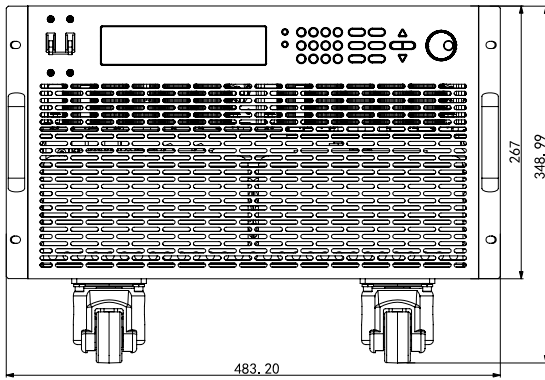

Model IT7322T

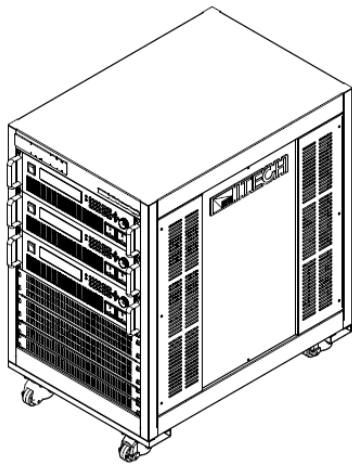

Detailed dimensional drawings

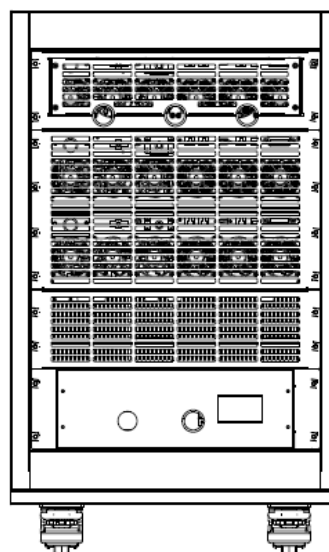
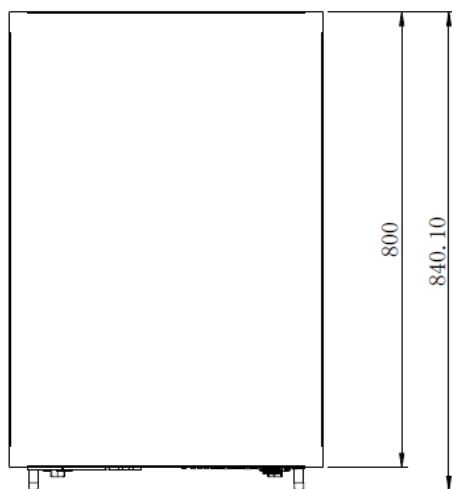
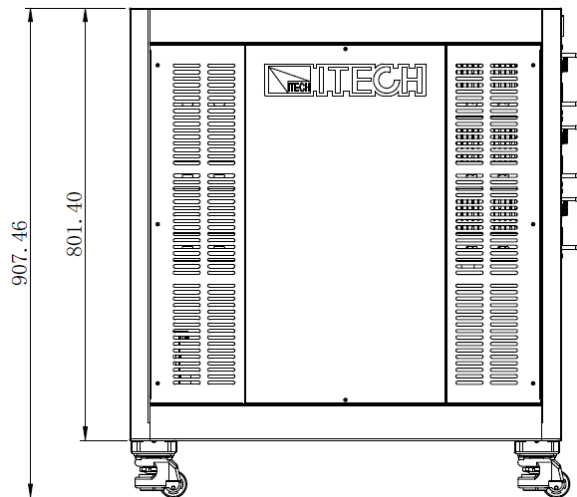
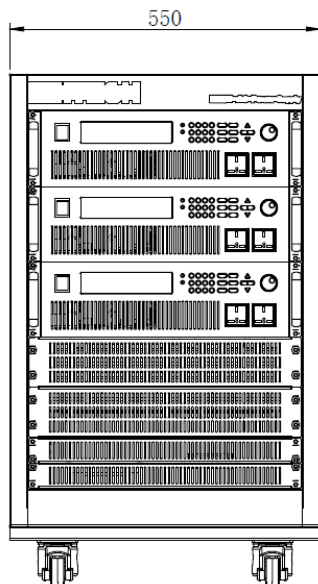

Model IT7322HT

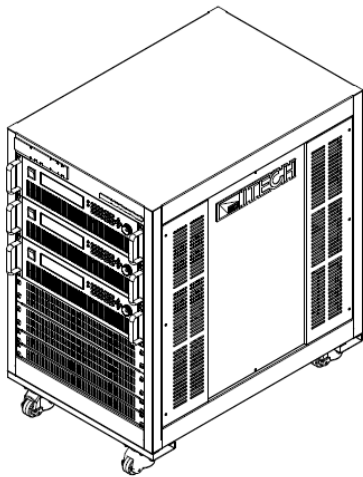

Detailed dimensional drawings

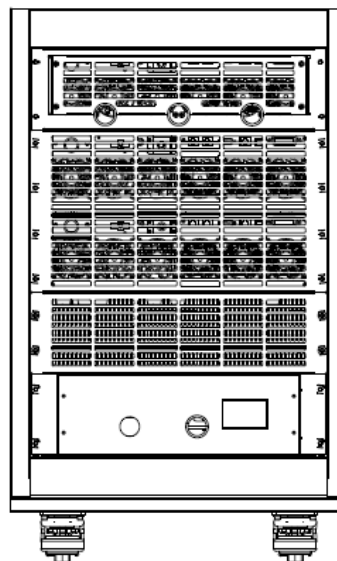
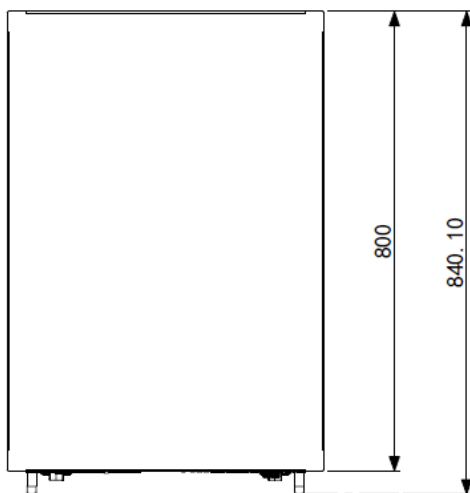
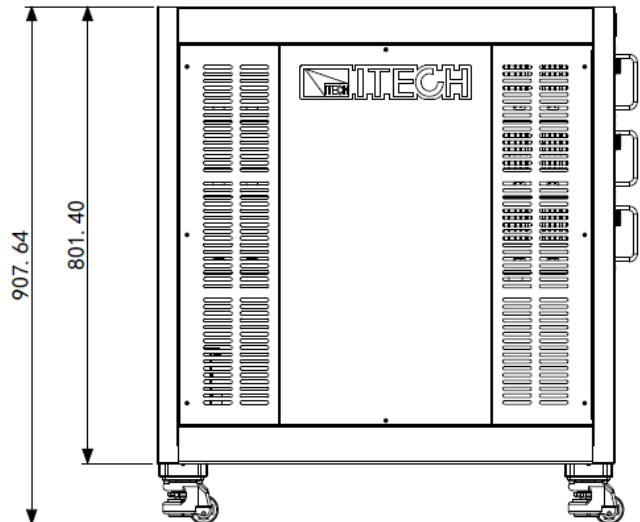
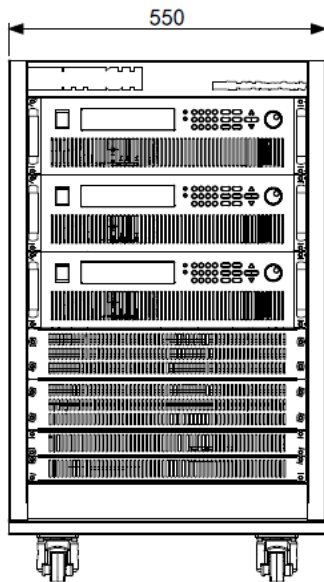

Model IT7324T

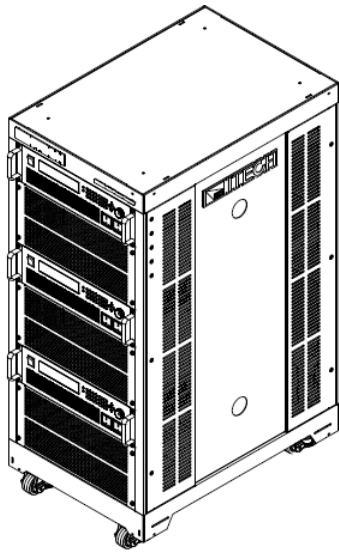

Detailed dimensional drawings

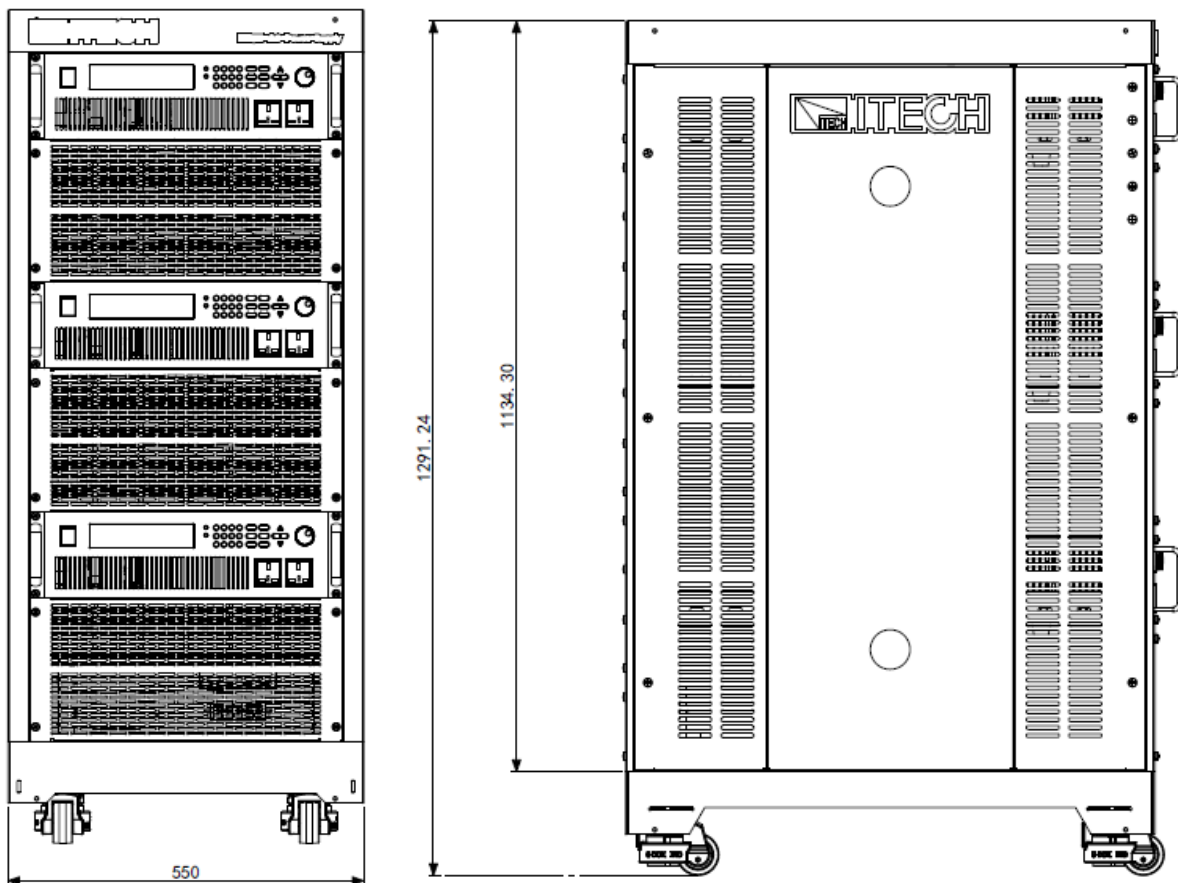

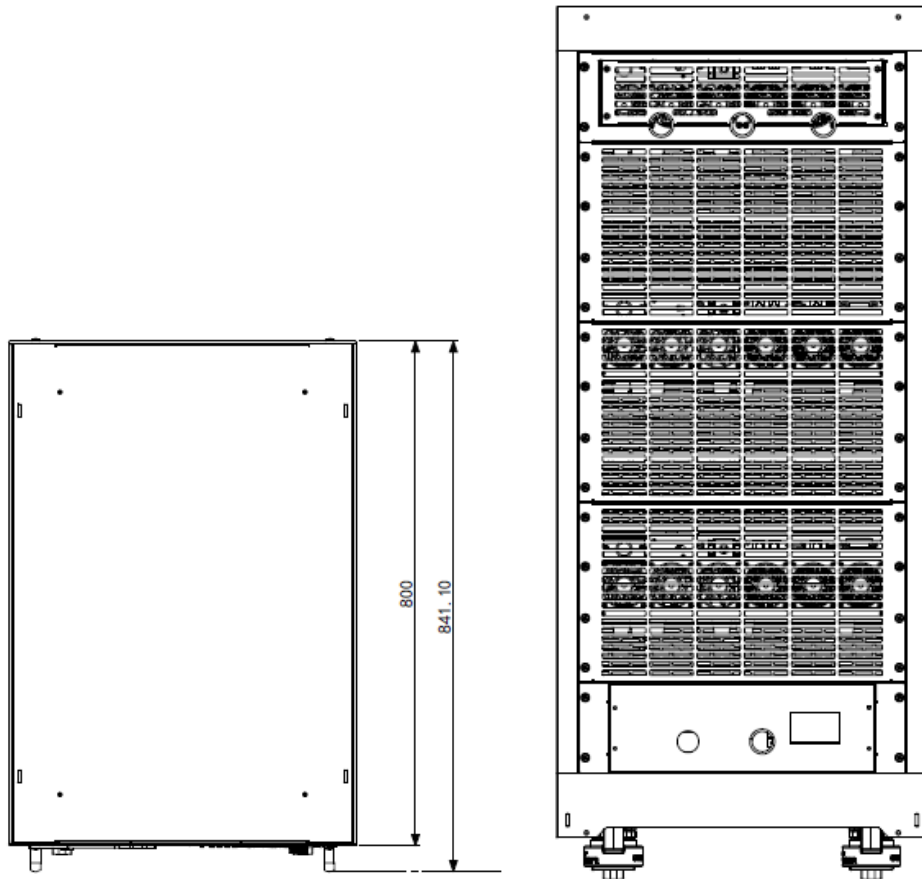

Model IT7324HT

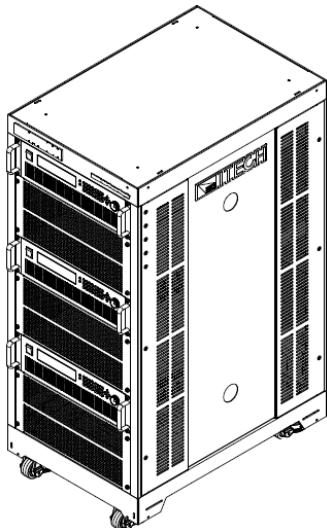

Detailed dimensional drawings

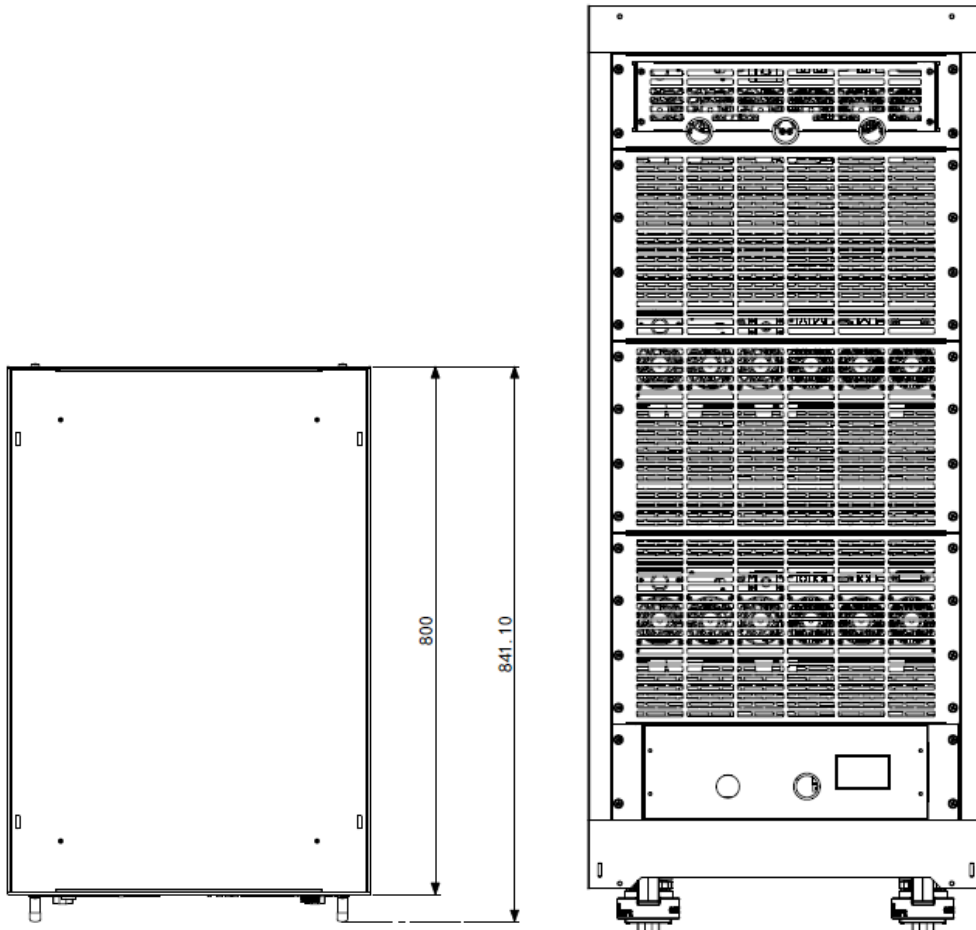
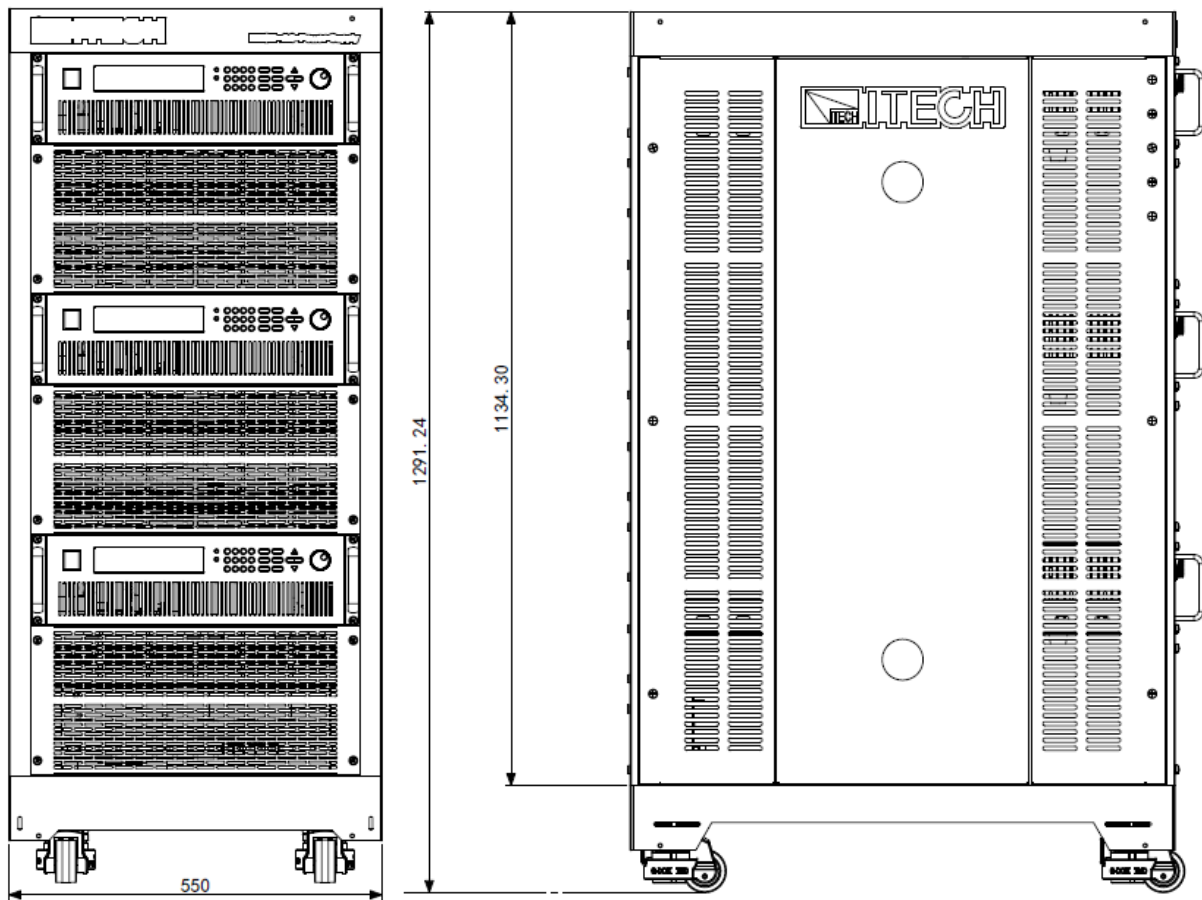

Model IT7326T

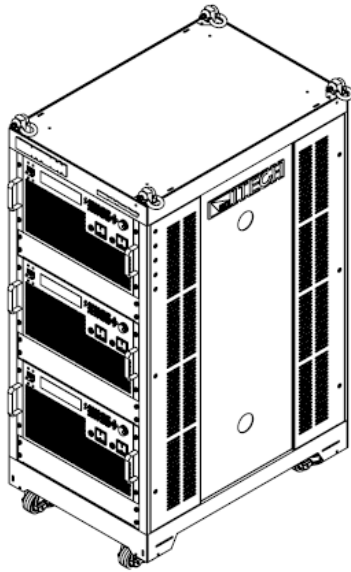

Detailed dimensional drawings

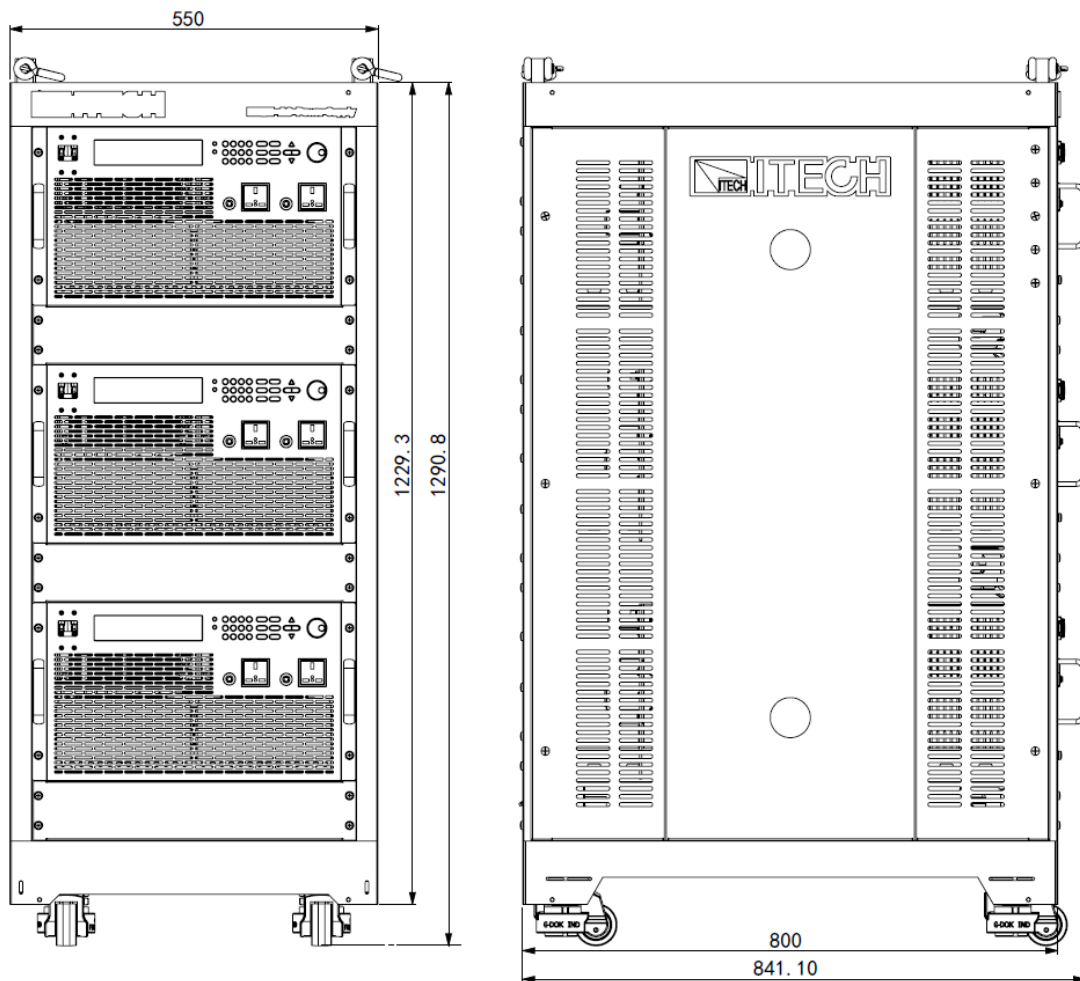

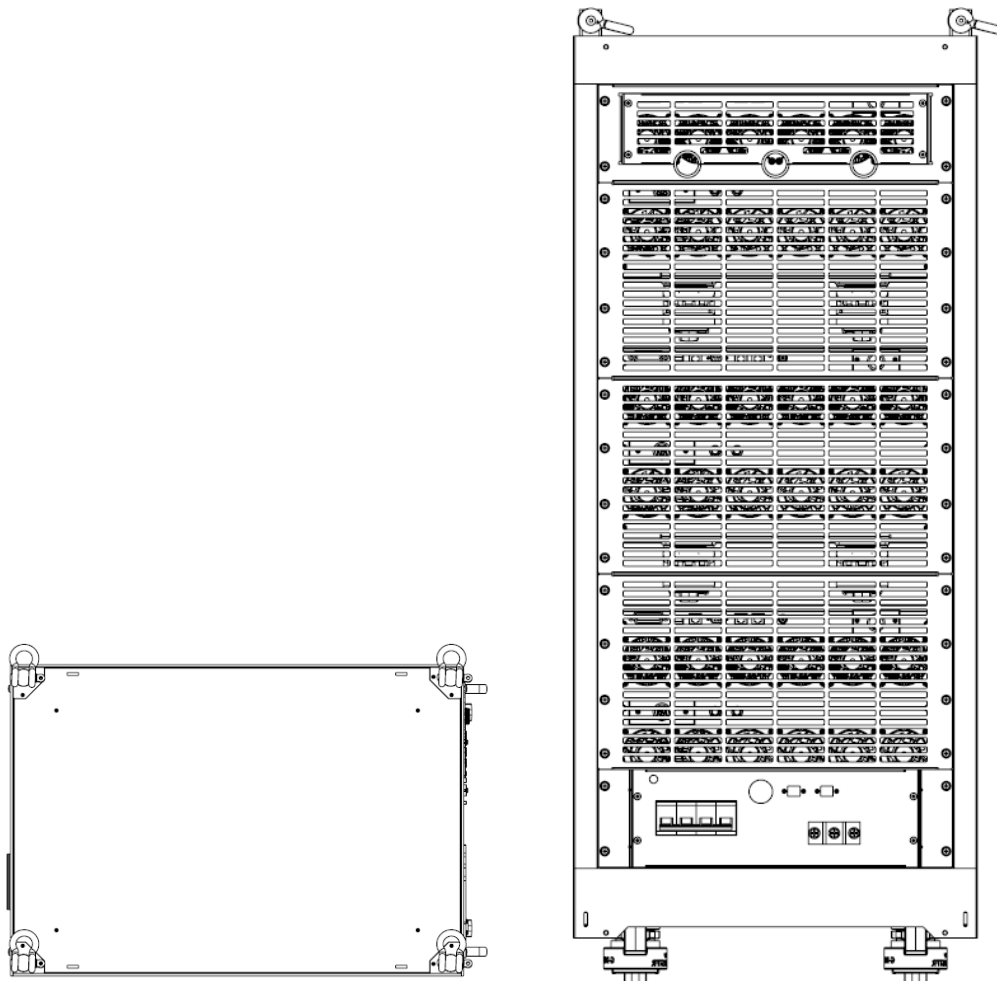

Model IT7326HT

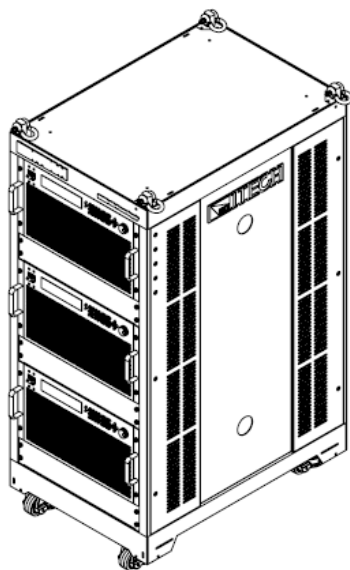

Detailed dimensional drawings

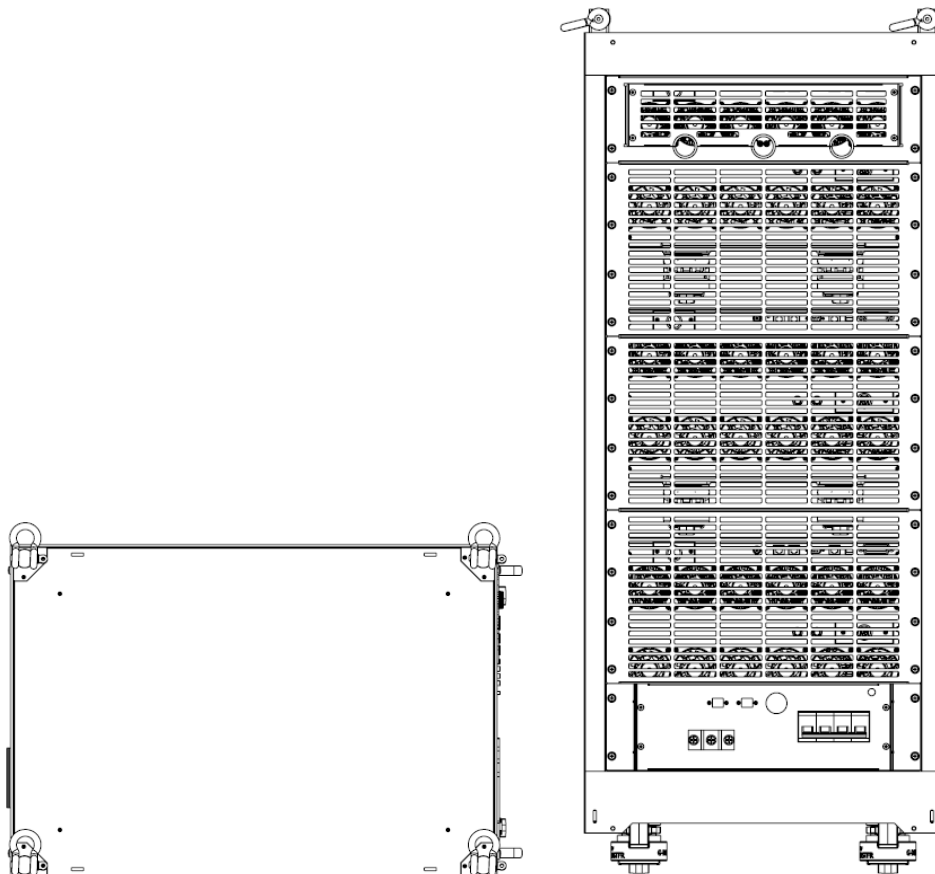
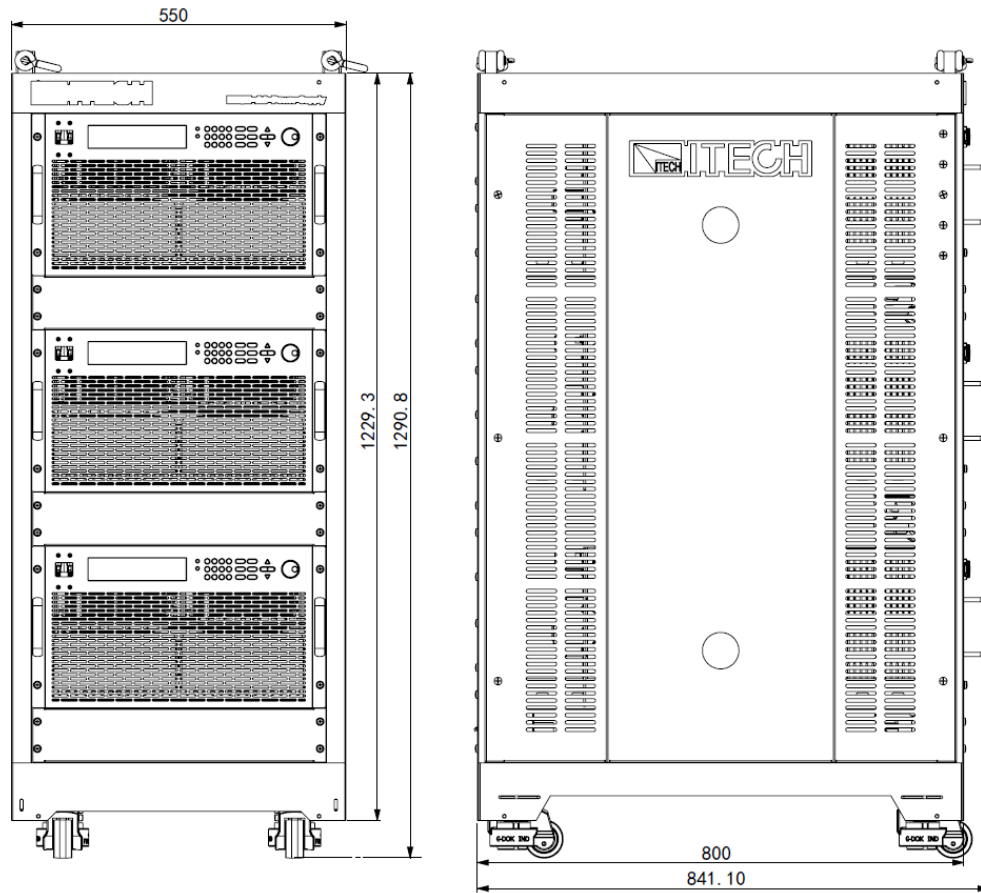

1.3 Installation of Power Cord

Connect power cord of standard accessories and ensure that the power supply is under normal power supply.

AC power input level

Working voltage for IT7300 series power supply is shown as follows. So please pay attention to the working input voltage.

- IT7321, IT7322, IT7322H, IT7324, and IT7324H models support 110V/220V AC input.

The AC line switch of IT7321 is located at the bottom of the unit.

The AC line switches of IT7322, IT7322H, IT7324, and IT7324H are located at the rear of the unit. Please pay attention to the AC level setup before provide AC power.

AC power input level:

- Option 01: 220VAC \pm 10%, 47 to 63 Hz
- Option 02: 110VAC \pm 10%, 47 to 63 Hz
- IT7326 and IT7326H models support 220V AC input.
- IT7322T, IT7322HT, IT7324T, IT7324HT, IT7326T and IT7326HT models support 380V AC input.

Connecting AC Input

WARNING

The power cords supplied with this product is certified for safety. In case the supplied lines assembly needs to be replaced, or an extension lines must be added, be sure that it can meet the required power ratings of this product. Any misuse voids the warranty of this product.

Before connecting power cords, turn off the power.

- IT7321: Connect standard power cord to the power supply input terminal.

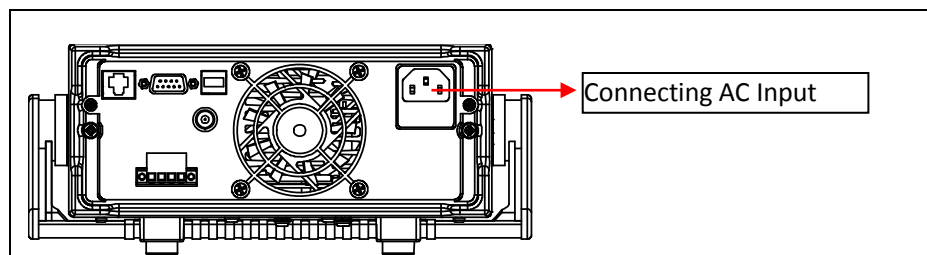

- IT7322/IT7322H/IT7324/IT7324H/IT7326/IT7326H AC input connector as follows. (Take the example of IT7324H.)

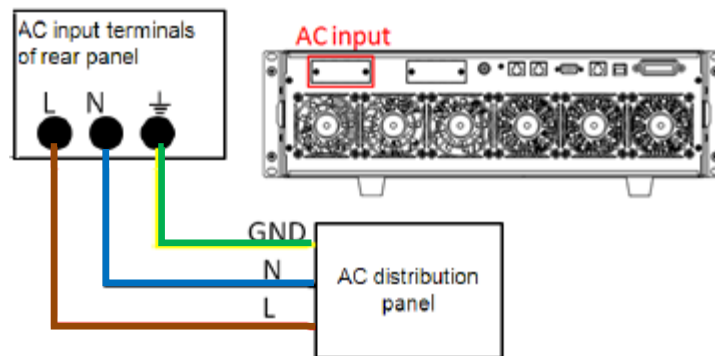

1. In the above illustration, one end of the AC power cord is connected to the AC input terminal in the rear panel of the power supply.
Connect the wire, zero line and ground to the corresponding terminal of the device. Before inserting, please loose the screw, lock the screw when it is inserted.
 2. Connect the three terminals brown to line (L), blue to neutral (N), and yellow-green to ground (GND) on the other end of the power cord to your AC distribution panel.
- IT7322T/IT7322HT/IT7324T/IT7324HT/IT7326T/IT7326HT AC input connections are the same, and the end of the AC power cord connected to the AC input terminal on the rear panel of the power supply is connected. The user only needs to connect the other end of the AC power cord to the AC distribution panel, the brown terminal is connected to L1, the gray terminal is connected to L2, the black terminal is connected to L3, the blue terminal is connected to N, and the yellow terminal is connected to the GND.

The connection diagram is as follows:

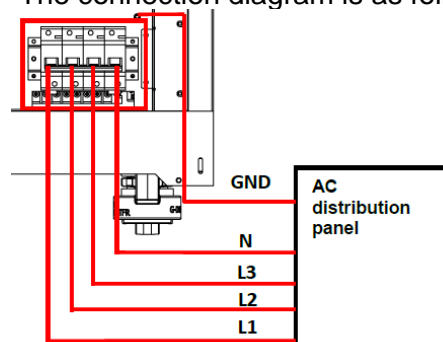

1.4 Connecting Test Cables (Optional)

Test cables are not standard accessories of the instrument. Please select optional red and black test cables for individual sales based on the maximum current value. For specifications of test cables and maximum current values, refer to “**Specifications of Red and Black Test Lines**” in “**Appendix**”.

WARNING

- Before connecting test cables, be sure to switch off the instrument. Power switch is in Off position. Otherwise, contact with output terminals in rear panel may cause electrical shock.
- To avoid electrical shock, before testing, please make sure the rating values of the testing cables, and do not measure the current that higher than the rating value. All test cables shall be capable of withstanding the maximum short circuit output current of the power supply without causing overheat.
- If several loads are provided, each pair of load wires shall safely withstand the rated short circuit output current of the power supply under full load.
- Always use test cables provided by ITECH to connect the equipment. If test cables from other factories are used, please check that the test cable can withstand maximum current.

The front panel of IT7300 series power supply is equipped with the front panel output terminal and rear panel output terminal (see **2.2 Introduction of front panel** and **2.5 Introduction of rear panel**).

Before using the output terminal of the rear panel to connect the device under test (DUT), remove the protective cover or panel covering the output terminal on the rear panel firstly, then connect the test cables, and take the other end of the test cables out of the hole in the protective cover or panel, and then put the protective cover or panel back in place. To avoid the risk of electric shock if the output terminal is accidentally touched during the test operation.

Connection of the front panel output terminal

The models that support the front panel output are: IT7321, IT7322, IT7324, IT7326, IT7322T, IT7324T, and IT7326T.

The connection method of the front panel output is as follows: directly insert the plug at one end of the cable into the output interface of the front panel, and connect the other end to the DUT.

The maximum output current of the front panel output terminal is 10A. In order to facilitate operation, the user can directly connect the front panel output terminal if the output current is less than 10A.

If the output current of the output terminal of power supply exceeds 10A, the user must connect the rear panel output terminal. If you want to obtain the specifications of the equipment, please refer to **4.1 Specification**.

Connection of the rear panel output terminal

The user can connect the rear panel output terminal according to the power output specifications. Specific connection of IT7321/IT7322/IT7322H/IT7324/IT7324H/IT7326/IT7326H (after removing the protective cover) is shown in the figure below.

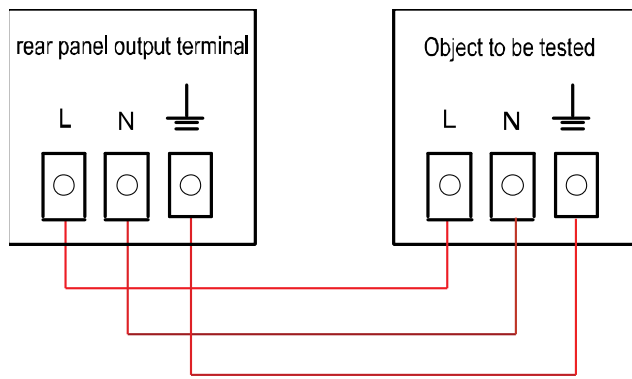

Specific connection of IT7322T/IT7322HT/IT7324T/IT7324HT/IT7326T/IT7326HT (after removing the panel) is shown in the figure below.

- When used as a single-phase power source, the connection is shown in the next figure.

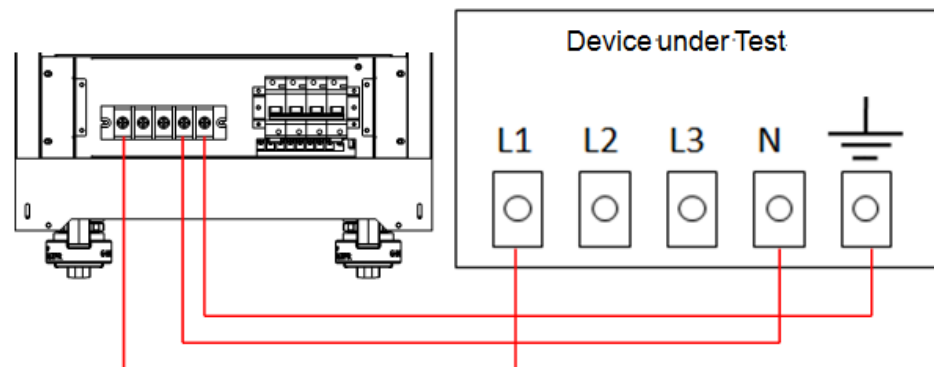

WARNING

When IT7322T/IT7322HT/IT7324T/IT7324HT/IT7326T/IT7326HT is used as a single-phase power source, please connect the output terminals: L1, N, GND.

- When used as a three-phase power source, the connection is shown in the next figure.

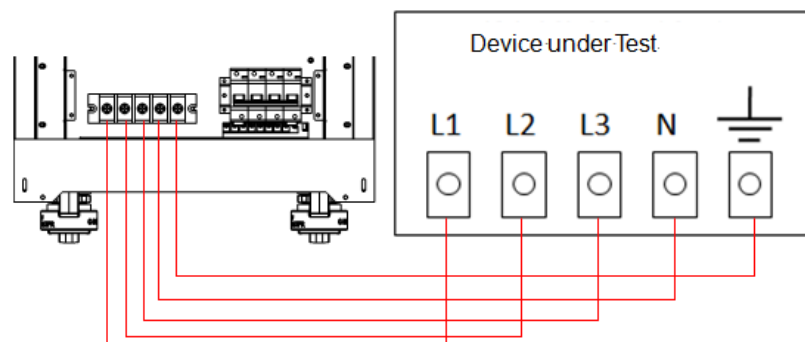

The specific steps for connecting the rear panel output terminals are as follows:

1. Make sure the power switch of the instrument is off.
2. Remove the protective cover or panel that covers the rear panel output terminals.
3. Unscrew the screws of the output terminals and connect the red and black test cables to the output terminals. Re-tighten the screws.

When maximum current that one test cable can withstand fails to meet the current rated current, use several pieces of red and black test cables. For example, the maximum current is 1,200A, then 4 pieces of 360A red and black cables are required.

4. Take the other end of the test cables out of the hole in the protective cover or panel and install the cover or panel back.
5. Connect the other end of the red and black cables to the DUT terminal.

Chapter2 Quick Start

This chapter introduces the front panel, the rear panel, key functions and VFD display function of the power supply, make sure that you can quickly know the appearance, instruction and the key function before you operate the power supply. Help you make better use of this series of power supply.

2.1 Brief Introduction

IT7300 series of power supply is divided into the single-phase (IT7321/IT7322/IT7322H/IT7324/IT7324H/IT7326/IT7326H) and three-phase (IT7322T/IT7322HT/IT7324T/IT7324HT/IT7326T/IT7326HT) programmable AC power supply. The three-phase power supply is assembled by three corresponding single-phase power supplies. For example, IT7322T is assembled by IT7322. Therefore, the introduction to front panel, key, VFD indicator, rear panel, power-on selftest, voltage output checkout, and function and features of three-phase power supply are similar to those of single-phase power supply.

IT7300 series can analog various AC inputs, and measure a series of important parameters of DUT. IT7300 series power supply has following standard communication interfaces: LAN, USB, and RS232. With combined features of both desktop and systematic power supplies, it can deliver multi-purpose solutions based on design and test requirements. Main features and advantages are listed below:

- Vacuum fluorescent display (VFD)
- LED display of panel function keys
- Adjustable set values by knob
- Output is switch control
- Display Vrms, Irms, Ipeak, frequency, PF, apparent power and active power simultaneously
- Programmable frequency:45HZ-500HZ
- Turn on, turn off phase angle control (0-360°)
- Analog surge/trapped wave
- Support front and rear panel output
- High accuracy and resolution
- Memory capacity:10 groups
- Over-voltage, over-power, over-current, over-temperature protection features
- Smart temperature-control fan with low noise
- Standard communication interface LAN, USB, RS232
- Software monitoring via computer
- Support 3-phase AC power supply function when 3 units are connected together via System Bus (except IT7321)

Model		Voltage	Current	Power
IT7321	-	300V	3A	300VA
IT7322	IT7322(G)	300V	6A	750VA
IT7322H	IT7322H(G)	500V	3A	750VA
IT7324	IT7324(G)	300V	12A	1500VA

IT7324H	IT7324H(G)	500V	6A	1500VA
IT7326	IT7326(G)	300V	24A	3000VA
IT7326H	IT7326H(G)	500V	12A	3000VA
IT7322T	IT7322T(G)	300V	6A	2250VA
IT7322HT	IT7322HT(G)	500V	3A	2250VA
IT7324T	IT7324T(G)	300V	12A	4500VA
IT7324HT	IT7324HT(G)	500V	6A	4500VA
IT7326T	IT7326T(G)	300V	24A	9000VA
IT7326HT	IT7326HT(G)	500V	12A	9000VA

*IT7300(G) is the model with built-in GPIB, the function is the same as standard model, please check with ITECH for availability.

The output IV curve of this series is as follows:

- IT7300 series (300V series models)

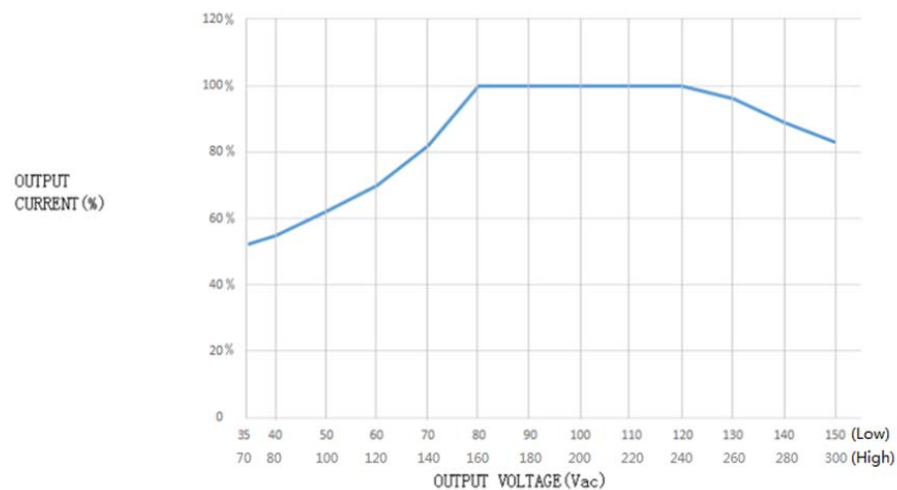

1: The minimum output voltage of the IT7300 series (300V series models) is limited, and the minimum AC voltage cannot be lower than 35Vac.

2: The ordinate is the percentage of the current rated value corresponding to different voltage gears.

- IT7300H series (500V series models)

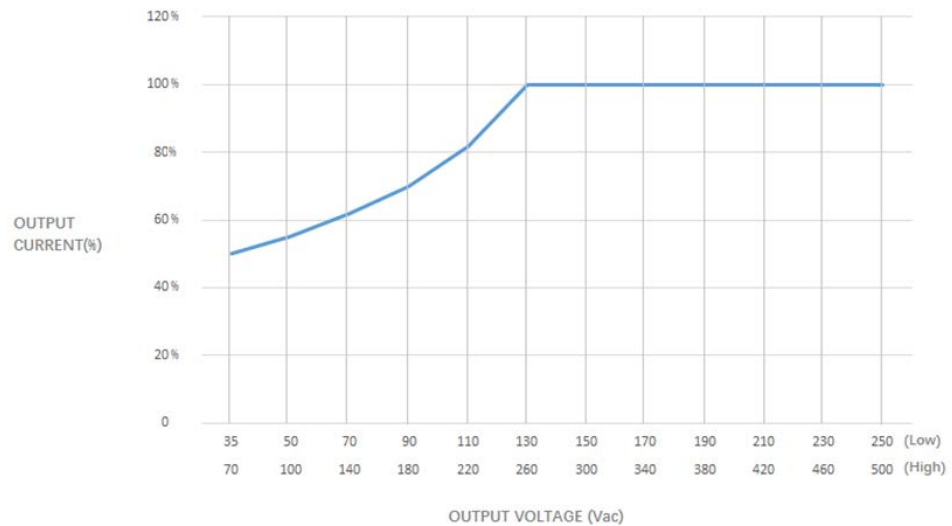

1: The minimum output voltage of the IT7300H series (500V series models) is limited, and the minimum AC voltage cannot be lower than 35Vac.

2: The ordinate is the percentage of the current rated value corresponding to different voltage gears.

2.2 Introduction of Front Panel

- Front panel of IT7321

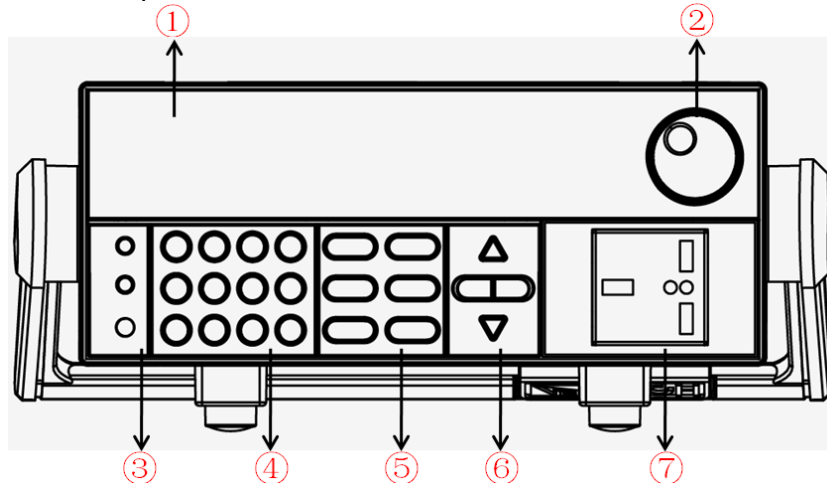

1. VFD display
2. Rotary knob
3. Compound key, the local switch key and power switch
4. Numeric keys and ESC
5. Function keys
6. UP, DOWN, LEFT and RIGHT key
7. Output terminals

- Front panel of IT7322/IT7324

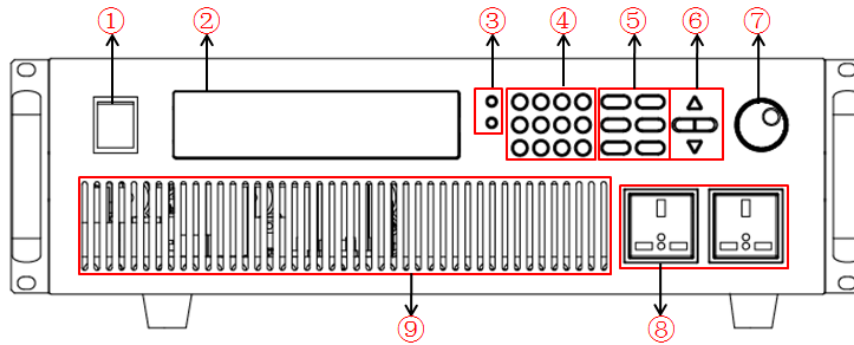

1. Power button
2. VFD display
3. Compound key, the local switch key and power switch
4. Numeric keys and ESC
5. Function keys
6. UP, DOWN, LEFT and RIGHT key
7. Rotary knob
8. Output terminals
9. Fan

- Front panel of IT7322H/IT7324H

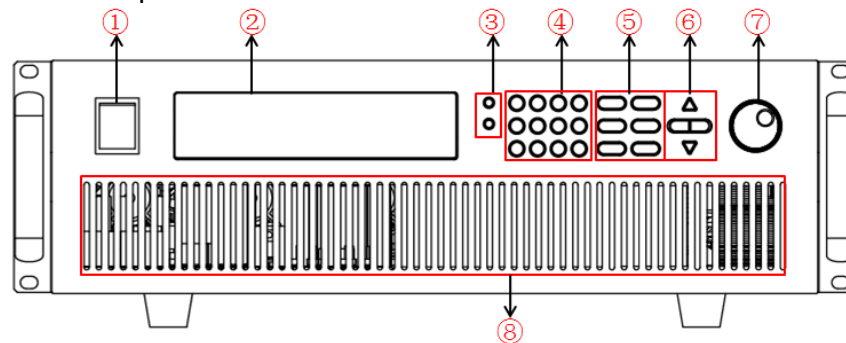

1. Power button
2. VFD display
3. Compound key, the local switch key and power switch
4. Numeric keys and ESC
5. Function keys
6. UP, DOWN, LEFT and RIGHT key
7. Rotary knob
8. Fan

- Front panel of IT7326

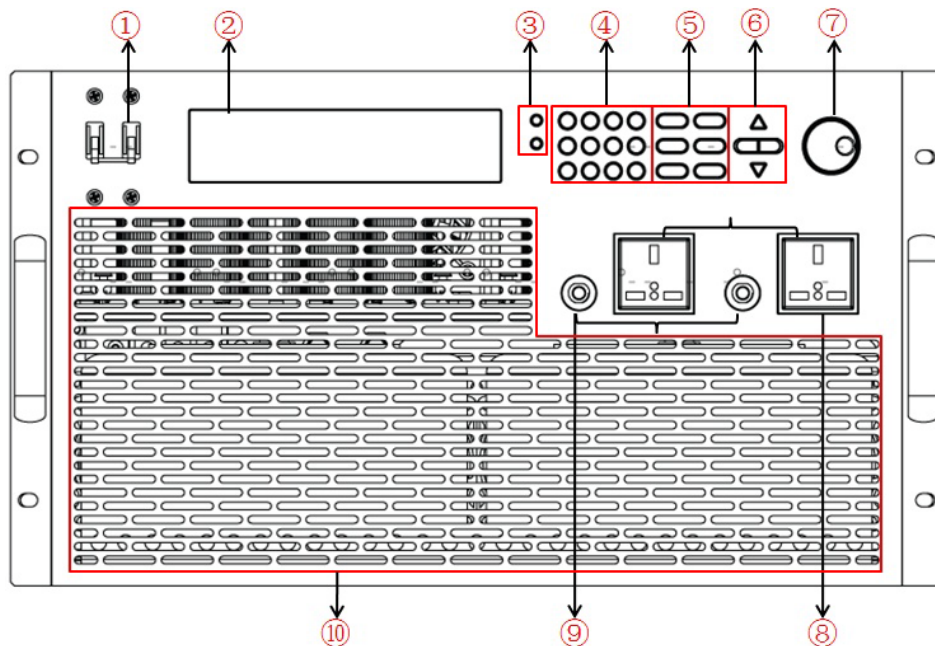

1. Power button
2. VFD display
3. Compound key, the local switch key and power switch
4. Numeric keys and ESC
5. Function keys
6. UP, DOWN, LEFT and RIGHT key
7. Rotary knob
8. Output terminals
9. Fuses
10. Fan

● Front panel of IT7326H

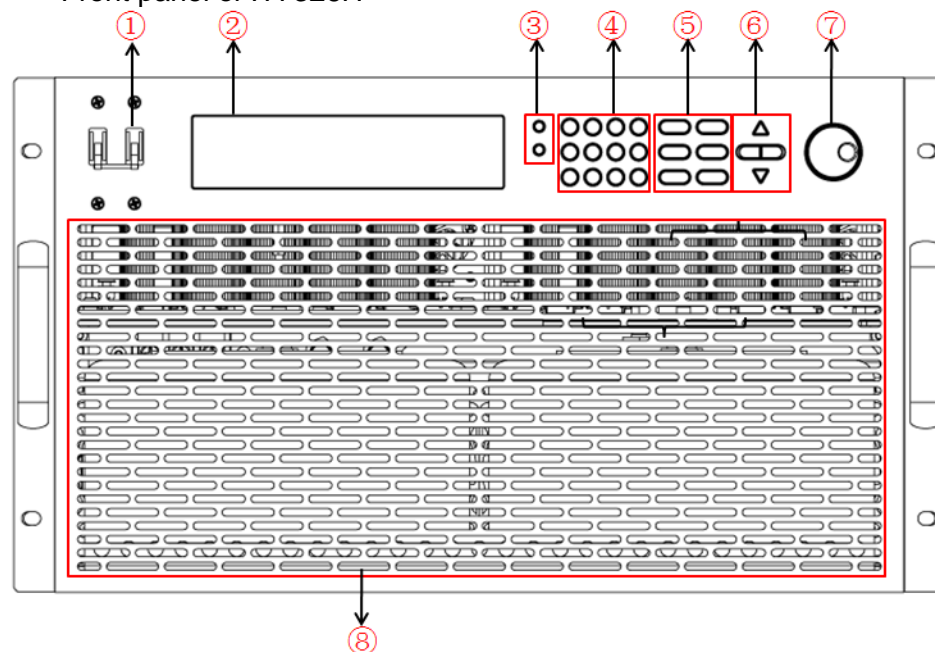







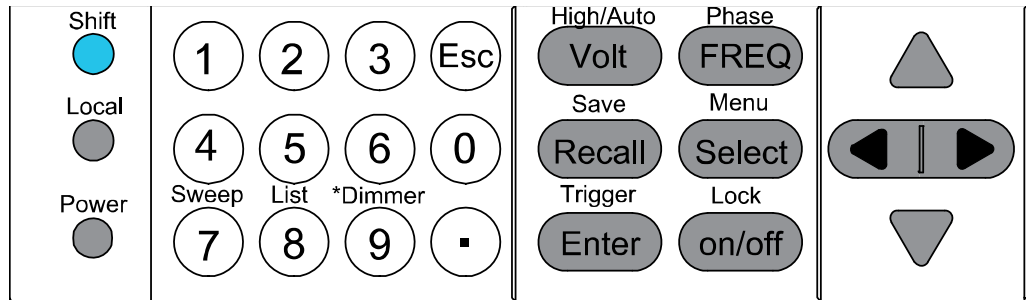







1. Power button
2. VFD display
3. Compound key, the local switch key and power switch

4. Numeric keys and ESC
5. Function keys
6. UP, DOWN, LEFT and RIGHT key
7. Rotary knob
8. Fan

2.3 Key Introduction



Key description, see the table below:

Keys	Name and the function
 (Shift)	Compound key, co-work with High/Auto, Phase, Save, Menu, Trigger, Lock, Sweep, List and*Dimmer.
 (Local)	Local button, switch from remote mode to local operation mode
 (Power)	Power on key
	Numeric keys
 /Sweep	Number 7/Sweep function key
 /List	Number 8/List function key
 /*Dimmer	Number 9/Dimmer function key
	Cancel /return keys
 /High/Auto	Set the voltage value/Switch the voltage range between high range and Auto range mode
 /Phase	Set the frequency /set the phase angle
 /Save	Recall the setup from internal memory/ Store the AC source settings in non-volatile memory.
 /Menu	Switch the VFD display to be apparent power, peak current, active power and power factor/entry the menu setup
 /Trigger	Enter key, to confirm the number entered and operation/trigger button, which is used to trigger the List test
 /Lock	Output on (off) keys, control power output state / keypad lock function keys, used to lock the panel buttons
	Left and right direction keys, used to set the value, to adjust the cursor to the specified location

	Up and down keys, used to turn over the item in the menu or increase (decrease) the output voltage or current values
---	--

2.4 VFD Indicator Description

VFD indicator function description as follow:

Char	Function description	Char	Function description
OFF	Output is off	Prot	OCP/OVP/OTP/OPP Protection
Rmt	The AC source is in remote mode	Auto	Auto change the voltage range
SRQ	Service request	*	Dimmer function is enabled
Error	The power supply has an error	Shift	Shift button is pressed
Trig	Awaiting for a trigger signal	Lock	Key operation is locked

2.5 Introduction of Rear Panel

- Rear panel of IT7321

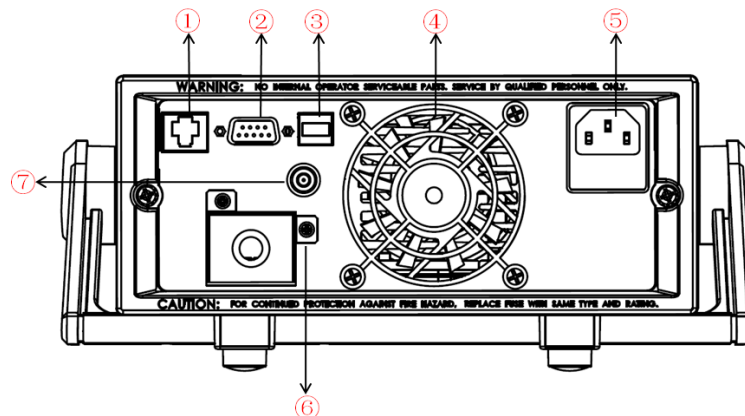

1. LAN communication interface
 2. RS232 communication interface
 3. USB communication interface
 4. Cooling fans
 5. AC power socket and Fuse
 6. Output terminals
 7. BNC terminal
- Rear panel of IT7322/IT7322H/IT7324/IT7324H

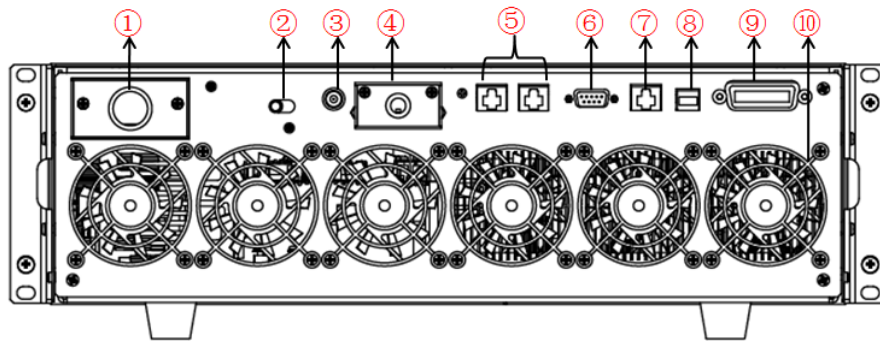

- Rear panel of IT7326/IT7326H

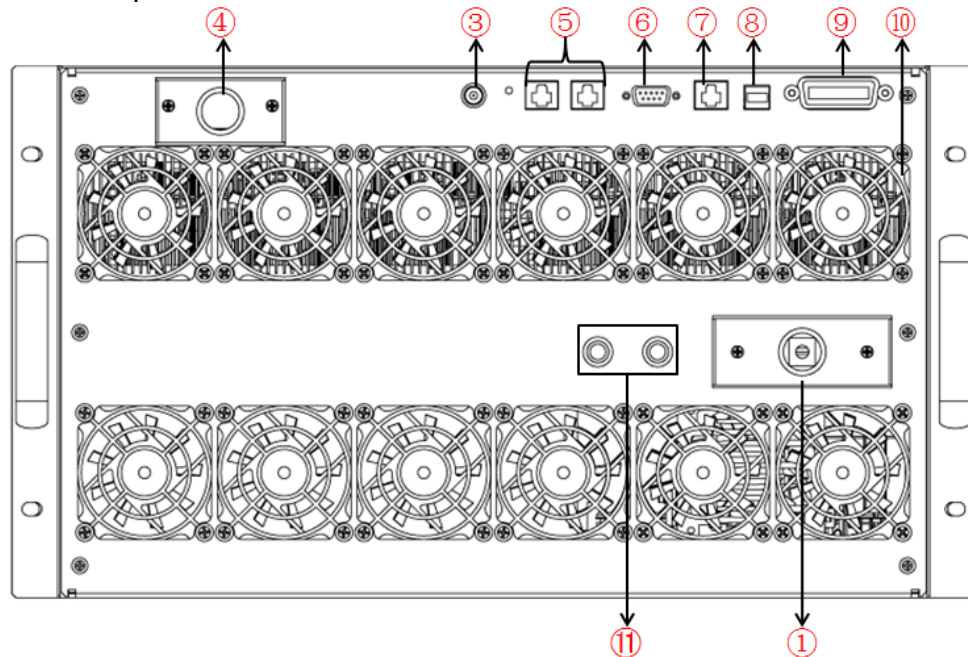

1. AC power input socket
2. 110V/220V AC power selection switch
3. BNC terminal
4. Output terminals
5. System Bus
6. RS232 communication interface
7. LAN communication interface
8. USB communication interface
9. GPIB communication interface (IT7300(G) series only)
10. Cooling fans
11. Fuses

The IT7322T, IT7322HT, IT7324T, IT7324HT, IT7326T, and IT7326HT are three-phase models that are composed of three single-phase power supplies. The AC power input terminals and output terminals are located below the rear panel of the cabinet. See the following illustration for details. For other terminals (such as communication interface terminals), you need to remove the rear panel of the corresponding position of the A-phase power supply, and then connect the terminals.

The IT7322T, IT7322HT, IT7324T, and IT7324HT rear panels have the same structure, so the IT7324HT is used as an example.

IT7324HT rear panel

IT7326HT rear panel

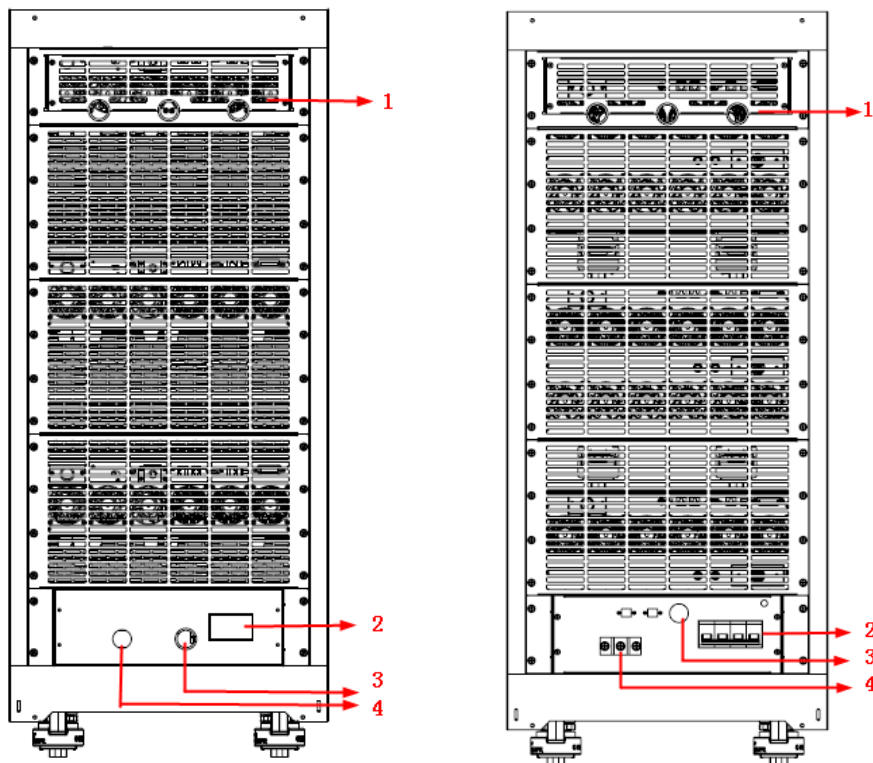

1. The rear panel of the corresponding position of the A-phase power supply.
Before using the rear panel terminal function, remove the panel and then connect the terminals.

CAUTION

The rear panel of the A-phase power supply (IT7322, IT7322H, IT7324, and IT7324H) of IT7322T, IT7322HT, IT7324T, and IT7324HT contains a 110V/220V switch. Do not move the transfer switch here, and keep it at 220V.

2. The main power switch of the cabinet.
3. The outlet hole of the AC power input cord.
4. The outlet hole of the AC power output cord (i.e., the test cables).

2.6 Power-on Selftest

A successful selftest indicates that the purchased power product meets delivery standards and is available for normal usage.

Before operation, please confirm that you have fully understood the safety instructions.

WARNING

- To avoid burning out, be sure to confirm that power voltage matches with supply voltage.
- Be sure to connect the main power socket to the power outlet of protective

grounding. Do not use terminal board without protective grounding. Before operation, be sure that the power supply is well grounded.

Power Switch Introduction

The switch status of single-phase power supply is as follows.



The three-phase power supplies are equipped with separate power switches, such as master switch and branch switch. The relationship of state of all equipment and switch states is as follow.

Master switch state	Branch switch state	State of all equipment
ON	ON	ON
ON	OFF	OFF
OFF	ON	OFF
OFF	OFF	OFF

Selftest steps

Normal selftest procedures:

1. Correctly connect the power cord. Press **Power** key to start up.

With regards to IT7322T, IT7322HT, IT7324T, IT7324HT, IT7326T and IT7326HT, you need to turn on three single instruments.

The power supply starts to selftest.

2. After selftest, VFD display the status as below:

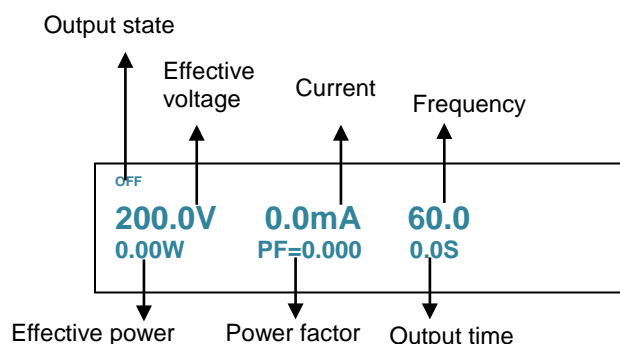

During self-test of the power supply, if EEPROM has error, the “Error” indicator on the status bar lights up. You can check the selftest error on the INFOR item in the MENU.

Exception handling

If the power supply cannot start normally, please check and take measures by

reference to steps below.

1. Check whether the power cord is correctly connected and confirm whether the power supply is powered.

Correct wiring of power cord => 2

Incorrect wiring of power cord => Re-connect the power cord and check whether the exception is removed.

2. Check whether the power in On. Power key is under “” On status.

Yes => 3

No => Please check the Power key to start power and check whether the exception is removed.

3. Check whether the fuse of power supply is burned out.

If yes, change fuse. Detailed steps: (Taking an example of IT7321):

- 1) Remove the AC power cord and open the plastic cover located at the AC power inlet, then you will see the fuse.

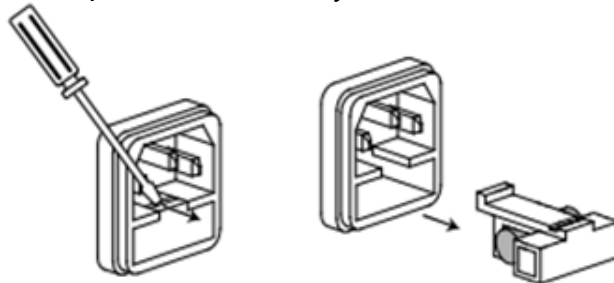

- 2) Replace with a fuse of the same specification and install it.

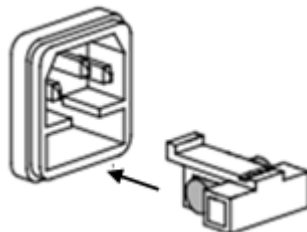

Fuse specification list:

Model	Fuse specification(220VAC)	Fuse specification(110VAC)
IT7321	6.3A	10A
IT7322	15A	30A
IT7322H	15A	30A
IT7324	30A	60A
IT7324H	30A	60A
IT7326	60A	Does not support 110VAC input
IT7326H	60A	Does not support 110VAC input



NOTE

Fuse of IT7326/IT7326H/IT7326T/IT7326HT can unscrew directly by hand. For fuse position, see **Introduction of Rear Panel** for details. Remove the rear panel before replacing the fuse of IT7326T/IT7326HT.

IT7322/IT7322H/IT7324/IT7324H/IT7322T/IT7322HT/IT7324T/IT7324HT fuse is inside the power supply and must be replaced by professional personnel.

2.7 Voltage Output Checkout

The following procedures check to ensure that the power supply develops its rated outputs and properly responds to operation from the front panel.

The following steps verify basic voltage functions without load.

1. Turn on the power supply.

 **Note**

IT7322T, IT7322HT, IT7324T, IT7324HT, IT7326T and IT7326HT are assembled by three single-phase instruments and can output three-phase AC power source. When you operate the instrument which is set to Phase A, the other two instruments will execute the same operation.

2. Press **Volt** and numeric key to set an effective voltage, press **Enter** to confirm.
3. Press **FREQ** and numeric key to set the frequency, press **Enter** to confirm.
4. Press **On/Off** to turn on the output. Note: When **On/Off** button is lit which means the output is ON, meanwhile indicator light of "OFF" on VFD will disappear.
5. Check the output waveform with an oscilloscope. Set different voltage and check whether the displayed voltage is close to setting voltage.
6. Ensure that the voltage can be adjusted from zero to the full rated value.

Chapter3 Function and Features

This chapter introduces the basic operations of IT7300 series AC source. IT7322T, IT7322HT, IT7324T, IT7324HT, IT7326T and IT7326HT are assembled by three single-phase instruments and can output three-phase AC power source. When you operate the instrument which is set to Phase A, the other two instruments will execute the same operation. The operations of the Phase A instrument are consistent with those of the corresponding single instrument.

Including the following subdivisions:









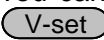

- Switching of local/remote operation modes
- Voltage setup
- Frequency setup
- Phase angle setup
- Output on/off operation
- Switch the VFD display items
- Save/recall operation
- Trigger operation
- Menu operation
- Function operation
- Output range
- Key lock
- BNC terminals function
- 3-phase AC power supply function

3.1 Switching of Local/Remote Operation Modes

Press the local button  to change the AC source from remote to local operation. After you power on the AC source, it defaults in local mode, all buttons are enabled. While in remote mode, most buttons are disabled except Shift and Local keys. In addition, the mode modification will not affect the output parameters.

3.2 Voltage Setup

You can set voltage within the range of rated voltage value. When you press  button, the button will be lit. This indicates that you can set voltage. There are three ways to set output voltage through front panel.

- The first way: press , adjust cursor location through  button, pressing  and  will enable you to adjust the setting voltage value.
- The second way: press , adjust cursor location through  button, adjust rotary knob  to change the setting voltage value.
- The third way: press  button and numeric key ( to ) to set voltage value.

3.3 Frequency Setup

You can set frequency within the range 45Hz to 500Hz. When you press **FREQ**, the button will be lit. This indicates that you can set frequency. There are three ways to set frequency through front panel.

- The first way: press **FREQ**, adjust cursor location through **◀▶** button, pressing **▲** and **▼** will enable you to increase or decrease the setting frequency value.
- The second way: press **FREQ**, adjust cursor location through **◀▶** button, adjust rotary knob **○** to change the setting frequency value.
- The third way: press **FREQ** button and numeric key(**0** to **9**) to set frequency value

3.4 Phase Angle Setup

You can set the starting and stop phase angle within range of 0~360° by pressing **○** (Shift)+ **FREQ** (Phase), VFD will display as below:

OFF	0.0V	0.0mA	50.0
Start	Phase= 0.0°		0.6S

Press numeric keys to set the starting phase angle and press **Enter** to confirm. Then the VFD will indicate next operation to set stop phase.

OFF	0.0V	0.0mA	50.0
Stop	Phase= 0.0°		0.6S

Press numeric keys to set the stop phase angle and press **Enter** to confirm.

3.5 Output On/Off Operation

On/Off button is used to control the output state of AC source. When **On/Off** button is lit, it indicates the output in on state. When output button is dark which means the output is turned off.

Note:

make sure you have connected AC source and test DUT very well, then press **On/Off** button to minimize shock hazard.

3.6 Switch the VFD Display Items

Press **Select** button to change the VFD display of bottom line.

Default VFD display: effective voltage, effective current, frequency

Active power, power factor, output time

OFF	0.0V	0.0mA	50.0
	0.00W	PF= 0.000	0.0S

Press **Select** to switch the display:
 effective voltage, effective current, frequency
 apparent power, peak current, output time

OFF	0.0V	0.0mA	50.0
	0.00VA	0.00A _{pk}	0.0S

Notes:

The time shown on the VFD is the output time of AC source. Press **On/Off** to start the timing when power is on; press **On/Off** again to turn off power. The duration of power supply will be displayed on the VFD until the next power starts when the timer will reset. The timing is based on the decimal system: when the time reaches 999.9 s, the timing will be displayed in minutes (m); when the time reaches 999.9 m, the timing will be displayed in hours (h).

3.7 Save and Recall Operation

IT7300 series AC source provides 10 non-volatile registers to save instrument settings for recall later. Each operating state includes preset voltage, preset frequency, starting and stop phase angle, output range level and dimmer phase angle.

- Press (Shift) + **Recall** (Save) key to recall /save settings.

Save operation:

To save the instrument's settings to a register, press shift **Recall** (Save). You'll be prompted for a register number. Enter a number between 0 and 9, then press the Enter key. The setting is saved.

OFF	2.0V	0.0mA	50.0
	Save data bank=0		0.0S

Recall operation:

Press **Recall** button, you'll be prompted for a register number. Enter a number between 0 and 9, then press the Enter key. The setting is recalled.



OFF	2.0V	0.0mA	50.0
	Recall data bank=0		0.0S

3.8 Trigger Operation

IT7300 power supply can be triggered by means of manual trigger (MENU), command trigger (BUS) and external trigger (EXTERN). Manual trigger means to trigger by keys; command trigger means to trigger through the communication command when PC is used for control; and external trigger





means to trigger by the BNC terminal at rear panel.

To trigger operation by the panel, you need to set the trigger operation mode (TRIG) in the system menu to MENU. For details, see Section 3.9 Menu Operation.

During surge/trapped wave test under List operation, press  (Shift) +  (Trigger) to trigger surge/trapped wave. When LIST file is running, the trigger function key  (Trigger) will flick.

3.9 Menu Operation

3.9.1 Menu Description

Press  (Shift)+  (Menu) to enter menu. View the menu on the VFD, and use the direction keys or the knob to scroll through the complete menu listed below. Press  to enter the selected menu function, press  to return to the previous menu.

MENU				
System	Init	INITIALIZE	Initialize system menu	
		Esc	Cancel initialization	
		Enter	Confirm initialization	
	Power-On	POWER-ON PARAMENT	Set the Power ON/OFF state after power up.	
		Sav0(Def)	The preset parameter stored in group 0	
	Rst	Factory Default		
	Power-Out	POWER-OUT	Power on state set	
		Off(Def)	In the state of power off	
		Last	In the state of latest power-off state	
	Buzzer	BUZZER	Set buzzer state	
		On(Def)	Buzzer on	
		Off	Buzzer off	
	Trigger	TRIGGER SOURCE	Trigger source selection.	
		Manual(Def)	Manual trigger	
		Bus	Bus trigger	
		Extern	External trigger	
	Communication	COMMUNICATION	Communication interface and parameter setting	
		GPIB(IT7300(G) series only)	Address	Available range from 0-31
		RS232(Def)	RS232	Select RS232 interface
			4800, 8, N, 1	Set Baud rate, data bit, odd-even check, stop bit and address
			9600 O 2	
			19200 E	
			38400	
		57600		
		115200		
	USB	Select USB interface		
	LAN	LAN	Select LAN interface	
		Gateway=192.168.0.1 IP=192.168.0.125 Mask=255.255.255.0 Socket Port=30000	Set gateway, IP address, mask address and port.	

	RelayCtrl	It is used to control whether the switch status of the output relay is frequently closed. When set to the Close state, the relay is always closed regardless of whether the output is turned on or off, which is convenient for extending the useful life of the relay.		
		Open	The switch status of the relay switches with the state of the output. <ul style="list-style-type: none"> ● When the output is turned on, the relay is closed; ● When the output is turned off, the relay is disconnected. 	
		Close	The switch status of the relay is frequently closed. <ul style="list-style-type: none"> ● When the output is turned on, the relay is closed; ● When the output is turned off, the relay is closed. 	
Config	CONFIG	Config menu		
	Volt-Min	Voltage lower limit		
		Volt-Min=0.0V	Set Min. voltage	
	Volt-Max	Voltage upper limit		
		Volt-Max=300.0V	Set Max, voltage	
	Freq-Min	Frequency lower limit		
		Freq-Min=45.0Hz	Set frequency lower limit	
	Freq-Max	Frequency upper limit		
		Freq-Max=500.0Hz	Set frequency upper limit	
	Irms-Protect	Current RMS protect point		
		Irms-Protect=12.000A	Set current RMS protect point	
			Delay	Irms protection will be triggered in 1s
			Immediate	Protection will be triggered immediately.
	BNC-Set	BNC PORT SETUP		
		I-Trigger	Input interface for external trigger	
		I-Ri	Input interface for on/off control	
		O-Sync	Output interface for AC phase synchronization signal	
		O-On	Output interface for on/off state interface	
	Ipeak-Protect	Current peak protect point		
		Ipeak-Protect=12.000A	Set Current peak protect point	
			Delay	Irms protection will be triggered in 1s
			Immediate	Protection will be triggered immediately.
	Dimmer	DIMMER		Phase dimmer
		LeadingEdge	LeadingEdge Phase dimmer function	
		TrailingEdge	TrailingEdge Phase dimmer function	
		Off	Disable Phase dimmer function	
	List-Set	LIST START MODE		List start mode
	On/Off	Press On/Off to start/stop running		
	Trigger	Press Shift + Enter (Trigger) to start/stop running		

	3 ϕ -Setup	A-Phase/ B-Phase / C-Phase	Set the power supply to A-Phase, B-Phase or C-Phase of AC power supply, with difference of 120 degrees between any two phases.		
		Disable/Enable	Turn on or turn off three-phase output function. To achieve this function, user need to combine three units.		
	Meas- Curr-mode	Auto	Select automatic current measurement mode		
		Manual	Select manual current measurement mode		
			High	Select high-range current measurement	
			Middle	Select mid-range measurement	
		Low	Select low-range measurement		
Info	PRODUCT INFO:	Power information			
	ERROR INFO:	For look up error information			
	PRODUCT INFO: IT73XX Ver:0.01~0.01	Instrument type/Firmware version			
	PRODUCT SN: XXXXXXXXXX XXXXXXXX	Instrument SN			
	RECORD INFO:	Record information			

Notes:

IT7321 has no GPIB and 3 ϕ -Setup menu items.

3.9.2 Menu Function

Initialize the system menu

Relative factory default setup as follows:

Power-On	Sav0
Power-Out	Off
Buzzer	On
Trigger	Manual
Communication	RS232

Power-On

This parameter determines the state of the AC source after power up. If you select "Rst", the default output parameter settings will be active after power up. The default setup is 0V,50HZ, 0° and 0°. If you select "Sav0", then the AC source will automatically recall the output parameters setting saved in 0 register

Note, please save these parameters in memory0 according to 3.7.

Power-Out



This parameter sets the output on/off state at power up. If you select "Last", the

AC source will save the output state prior to power down and revert to that state at power up. If you select “off”, the output state is always “off” when the power supply is turned on. The recommend setting is “OFF”.

Buzzer

This item can set the key sound state. If in ON mode, then when you press a button, the power supply will beep. If in OFF mode, the beeper will not make a sound. The default set is in ON mode.

Trigger source

This item can set the trigger signal to Keyboard trigger, Command trigger or External trigger during surge/trapped wave test under List operation. If Manual is selected, the trigger signal is provided by  (Shift) +  (Trigger) on the panel; if Bus is selected, command trigger mode is used; if External trigger is selected, the trigger signal is provided by the trigger terminal (BNC) at the rear panel. BNC is a composite terminal. You need to set its function to I-Trigger in the Menu. For details, refer to Section 3.13 BNC. **Set Factory Setting to Manual.**

Setting of Communication Interface

This item can set communication modes of the power supply. IT7321 has the following standard communication interfaces: LAN/USB/RS232; and the others have the following standard communication interfaces: LAN/USB/RS232. You can choose any one of them to communicate.

RS232 Baud rate: 4800/9600/19200/38400/57600/115200. Data bit: 8; check bit: NONE, ODD, EVEN; stop bit: 1~2;

LAN parameters include Gateway address (Gateway), IP address (IP), Mask address (Mask) and port (Socket Port).

When communication with computer, you need to select a communication interface and set its corresponding configurations so that the communication settings of the power supply are same with the PC configurations.

Config menu

The configuration menu is described below:

Volt-Min:	Voltage lower limit setting
Volt-Max:	Voltage upper limit setting
Freq-Min:	Frequency lower limit setting
Freq-Max:	Frequency upper limit setting
Irms-Protect:	Current RMS upper limit setting
BNC-Set:	Select BNC composite terminal function
Ipeak-Protect:	Peak Current upper limit setting
Dimmer:	Set phase dimmer
List-Set	Select List start mode
3 ϕ -Setup	Set 3-phase AC power supply function
Meas-Curr-mode	Switch current measurement mode

Protection function

This series of power supplies have the following protection information prompts:

- **OCrms**

Current RMS value overcurrent protection. When the power supply appears in the **OCrms** protection state, first disconnect the DUT, and then press **[Esc]** to clear the protection.

1. Enter **Menu > Config > Irms-Protect** to view the set value of the overcurrent protection point.

When the actual output current RMS value reaches this protection point, **OCrms** protection is triggered.

2. Press the **[Enter]** key and select **[Delay]**, which means that the protection is triggered with a delay of 1S.
3. If the **OCrms** protection is still triggered after **Step 2** is executed, use an oscilloscope to capture the current waveform and check whether the actual RMS value of the current exceeds the rated value of the instrument.

- **OCpeak**

Current peak value overcurrent protection. When the power supply appears in the **OCpeak** protection state, first disconnect the DUT, and then press **[Esc]** to clear the protection.

1. Enter **Menu > Config > Ipeak-Protect** to view the set value of the overcurrent protection point.

When the actual output current peak value reaches this protection point, **OCpeak** protection is triggered.

2. Press the **[Enter]** key and select **[Delay]**, which means that the protection is triggered with a delay of 1S.
3. If the **OCpeak** protection is still triggered after **Step 2** is executed, use an oscilloscope to capture the current waveform and check whether the actual peak value of the current exceeds the rated value of the instrument.

- **OP**

Power supply over power protection.

The upper limit of the output power of the power supply is the rated power value of the instrument. When the actual output power exceeds the rated value of the instrument, the over power protection is triggered. When the power supply appears in the **OP** protection state, first disconnect the DUT, and then press **[Esc]** to clear the protection.

- **OV**

Power supply overvoltage protection.

The upper limit of the output voltage of the power supply is the rated voltage of the instrument. When the actual output voltage exceeds the rated value of the instrument, the overvoltage protection is triggered. When the power supply appears in the **OV** protection state, first disconnect the DUT, and then press **[Esc]** to clear the protection.

- **OT**



Power supply over temperature protection.

When the acquisition temperature of the internal component exceeds about 95°C, the power supply is over-temperature protected. At this time, the output will be automatically OFF, prompting OT. When the power supply is in the OT protection state, first disconnect the DUT, power off the power supply, ventilate the instrument and cool down, and then start the power supply in a cold state.

Switch current measurement mode (Meas-Curr-mode)

This item can set the current measurement mode of the power supply. IT7300 series has two measurement modes: Auto and Manual. When Auto mode is chosen, the switchover among High range, Middle range and Low range will be performed by the instrument automatically. When Manual mode is chosen, the switchover among High range, Middle range and Low range will be performed by the user manually.

Check instrument information

1. Press  (Shift)+  (Menu) to enter menu operation
 Off
0.0V 0.0mA 50.0
0.00W PF=0.000 0.0S
2. Press right direction key to select INFO, press  to confirm
MENU
System Config Info
3. VFD displays product model and firmware version number. Press right key to display product serial number.
PRODUCT INFO:
IT73XX Ver:0.06~0.06

3.10 Function Operation

3.10.1 Sweep

The Sweep function is used to test efficiency of switching power supply and capture the voltage and frequency at the maximum power point. The voltage and frequency of power may be altered in the form of step ladder by setting the initial voltage, final voltage, step voltage, initial frequency, final frequency, step frequency and one-step time. The one-step time may be indicated in seconds, minutes or hours. A maximum of 10 files may be stored. As the test closes, voltage, frequency and current at the maximum power point may be displayed.



Note





This feature is not available in the three-phase model.

> Edit sweep file



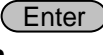
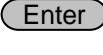
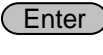
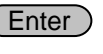
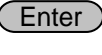
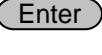
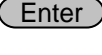
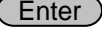
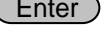
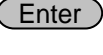

NOTE

In the following operations, up and down keys are used to turn over steps, but not to increase or decrease value. When up arrow appears in the lower left corner, you can press the up key to jump to the previous step. When down arrow appears in the lower right corner, press down key can entry the next step.

1. Press  (Shift)+  (Sweep) to enter menu operation
Off
0.0V 0.0mA 50.0
0.00W PF=0.000 0.0S
2. Press  to confirm when Edit is shining.
SWEEP
Edit Recall Disable
3. Press number key or knob to set start voltage, press  to confirm
START VOLTAGE
Voltage= 0.0V
4. Press numeric key or knob to set stop voltage, press  to confirm
END VOLTAGE
Voltage= 0.0V
5. Press numeric key or knob to set step voltage, press  to confirm
STEP VOLTAGE
Voltage=0.1V
6. Press left and right arrow keys to select time unit second, minute and hour, press  to confirm.
TIME UNIT
Second Minute Hour
7. Set step last time(0.1s~999.9s), press  to confirm
STEP TIME
Time=2.0S
8. Set start frequency(45Hz~500Hz), press  to confirm
START FREQUENCY
Frequency=50.0Hz
9. Set stop frequency(45Hz~500Hz), press  to confirm
END FREQUENCY
Frequency=50.0Hz
10. Set step frequency, press  to confirm
STEP FREQUENCY
Frequency=1.0Hz
11. Press left and right arrow keys to select whether save sweeping file," No" means do not saving, " Yes" means saving.
SWEEP SAVE
No Yes
12. Select save position(0~9), press  to confirm, VFD display "Save Data success!" for 1 second.
SWEEP SAVE
Save data bank=0
13. Return to Previous Menu and press  to exit menu.
SWEEP
Edit Recall Disable

> Recall sweep file

1. Press multiple keys  (Shift)+  (Sweep) to menu operation
Off
0.0V 0.0mA 50.0

- 0.00W PF=0.000 0.0S
- Press right arrow key then press **Enter** key to confirm when Recall key is shining.
SWEEP
Edit Recall Disable
 - Press numeric key to select needed recall file and press **Enter** key to confirm. VFD display “Recall Data success!” for 1 second.
RECALL SWEEP
Recall Sweep=0
 - Return to Previous Menu and press **Esc** to exit menu.
SWEEP
Edit Recall Disable

> Set sweep test state and start test

- Press multiple keys **(Shift)+ 7** (Sweep) to menu.
 Off
0.0V 0.0mA 50.0
0.00W PF=0.000 0.0S
- Press right arrow key to “Disable”, press down arrow key and **Enter** to infirm when “Disable” is shining. The word “Sweep” appears at the right bottom, which means the Sweep function is active.
SWEEP
Edit Recall Disable
- Press **On/Off** key to start sweep test. **Enter** key will be shining during test and will stop after that with power off automatically.
 Off
0.0V 0.0mA 50.0
0.00W PF=0.000 Sweep

After the test is finished, to exit Sweep function, you need to change the Sweep test status to Disable. Operating steps:

- Press multiple key **(Shift)+ 7** (Sweep) to menu operation.
 Off
0.0V 0.0mA 50.0
0.00W PF=0.000 0.0S
- Press right arrow key to “Enable”, press down arrow key and **Enter** key to confirm and then exit sweep function (Sweep words will disappeared on lower right of VFD display)
SWEEP
Edit Recall Enable

3.10.2 List Operation

With List operation applied to the alternating power supply, alternating waveform sequences in various ranges may be output. The surge/trapped wave may be added as required to simulate fluctuation of network voltage so as to evaluate the test result of the instrument under such situation.

Various alternating sequences with output varied may be formed by listing the voltage, frequency, slope, surge/trapped wave each step.



Note

This feature is not available in the three-phase model.

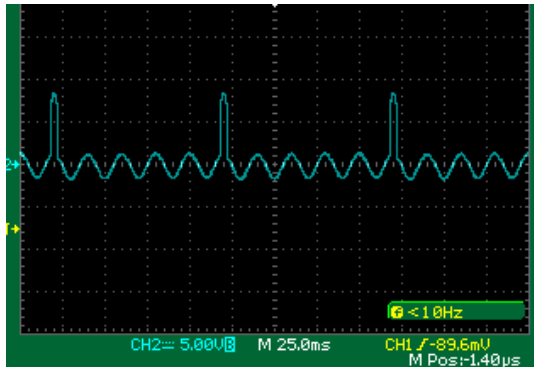





Surges wave









List sequences of IT7300 series can be stored into a non-volatile register, with a capacity of 100 steps. The user can edit up to 10 files. Following shows how to edit, recall and run a list file:

> Set Trigger Source

The surge/trapped wave test of LIST may be manually triggered to control the start time of the surge/trapped wave.

Press  (Shift)+  (Menu) to enter the menu. Then the system will keep flickering-----press  to confirm. Press right key to select Trigger. When selected, trigger item will be twinkling. Press  to confirm. Press right key to select Manual and press  to confirm.

> Edit LIST File

1. Press  (Shift)+  (List) button.
Off
2. Select Edit, press  to confirm.
0.0V 0.0mA 50.0
0.00W PF=0.000 0.0S
LIST
Edit Recall Disable
3. Press numeric key, set the step counts(range:1~100), press  to confirm.
STEP COUNT
Step Count=0
4. Press numeric key, set number of cycles(range:1~1000), press  to confirm.
LIST REPEAT
List Repeat=0
5. Set the first step voltage and press  to confirm.
LIST VOLTAGE
Step 0 Voltage=0.0V
6. Set the first step frequency and press  to confirm.
LIST FREQUENCY
Step 0 Frequency=50.0Hz
7. Set the slope(0.1~999.9),press  to confirm.
LIST SLOPE
Step 0 Slope=0.0S
8. Set the time unit: S, min, hour, press  to confirm.

DWELL UNIT
Second Minute Hour

- Set delay time(0.1~999.9),press **Enter** to confirm.

LIST DWELL
Step 0 Dwell=0.0S

- Disable or enable the surges or trap state, press **Enter** to confirm. If select Disable, then do nothing for step11-step14.

SD STATE
Disable Enable

- Press left/right key to set whether create surges/wave traps continuously. If select Yes, power supply will create surges/wave traps in at intervals of 100ms.Press **Enter** to confirm.

SD CONTINUE
No Yes

- Press numeric keys to set voltage of surges/wave traps, press **Enter** to confirm. If set voltage is higher than current working voltage, then it is surges, or it is wave traps.

SD VOLTAGE
Step 0 Voltage=0.0V

- Set the starting time of surges/wave traps, press **Enter** to confirm. With the restriction of frequency, the max settable time is 25ms.

SD SITE
Step 0 Site= 0ms

- Set the duration time of surges/wave traps. Press **Enter** to confirm.

SD TIME
Step 0 Time=0ms

- Repeat step4-13.

LIST VOLTAGE
Step 1 Voltage=0V

- NO: Do not save the list file, after power off the unit, current file will lose. Yes: Save list file to assigned memory room for quickly recall at any time.

LIST SAVE
No Yes

- Store file to specified storage space(0~9 groups), press **Enter** to confirm. VFD will display "Save data success!"

LIST SAVE
Save data bank=0

> Set LIST State

- Press **(Shift)+ 8** (List) to entry the List menu.
Off

0.0V 0.0mA 50.0
0.00W PF=0.000 0.0S

- Press right key to select Disable, when it flickers, press up/down key to select Enable, and press **Enter** to confirm.

LIST
Edit Recall Disable

- Now the List mode is enabled. Escape menu, the front panel will display "LIST 0".

LIST







Edit Recall Enable

- List mode is enabled
Off

0.0V 0.0mA 50.0
0.00W PF=0.000 List 0

> Run LIST File

When LIST is in Enable status, exit menu.

- If List-Set under Config menu is set to On/Off: Press  key to turn on power supply output, and LIST file starts running. Press  to stop running.
- If List-Set under Config menu is set to Trigger: Press  (Shift)+  (Trigger) key to trigger and the LIST file starts running. Press  (Shift)+  (Trigger) again to stop running.

List running flag: When List is running,  is flicking, and LIST step displayed at the right bottom of VFD will also change by setting as time elapses.

> Quit LIST Mode

- Press  (Shift)+  (List) to enter the List menu.
Off

0.0V 0.0mA 50.0
0.00W PF=0.000 0.0S

- Press right key to select Enable, when it flickers, press up/down key to select Disable, and press  to confirm. Indicating List mode is disabled.

LIST
Edit Recall Enable

- Press  to quit the List menu.

LIST
Edit Recall Disable

> Recall LIST Mode

If several List files are edited, you can recall the List file to be tested by Recall. When LIST is in Enable status, exit the menu to perform test.

- Press  (Shift)+  (List) button to enter the List menu
Off

0.0V 0.0mA 50.0
0.00W PF=0.000 0.0S

- Press right key to select Recall, when it flickers, press  to confirm.

LIST
Edit Recall Disable

- Press the file number to recall the assigned file. Press  to confirm. when recall successfully, the VFD will display "Recall data success!".

RECALL LIST
Recall List=0

- Return to Previous Menu and press  to exit menu.

LIST

Edit Recall Disable

- After recall, please enable the LIST state, then quit the menu and press ON/OFF to trigger the execution.

3.10.3 Dimmer

The leading and lagging edge of the waveform can be concealed and the phase angle set with Dimmer function to regulate the active power, thus adjusting the lighting intensity.

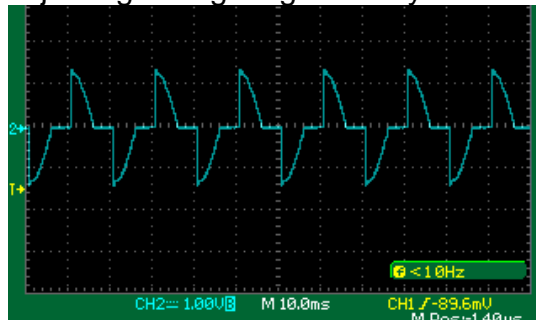

Dimmer of leading edge

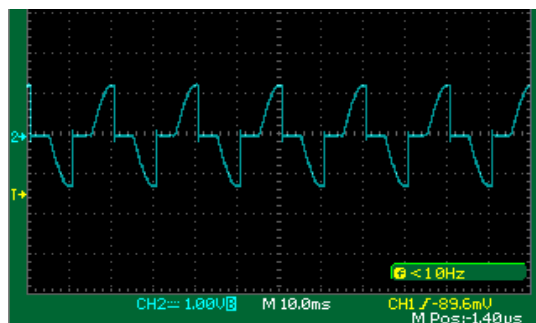

Dimmer of lagging edge







> Active dimmer function, set LeadingEdge /LaggingEdge

- Press multiple keys \odot (Shift)+ **Select** (Menu) to menu
Off
0.0V 0.0mA 50.0
0.00W PF=0.000 0.0S
- Press right arrow key to select " Config", press **Enter** to confirm when "Config" is shining
MENU
System Config Info
- Press right arrow key to "Dimmer" press **Enter** to confirm when "Dimmer" is shining.
CONFIG
Volt-Min Volt-Max >
- Select "LeadingEdge" or "LaggingEdge" to active the function. Press **Enter** key to confirm when it is shining. Shining "*" indicate on VFD means dimmer function is in used, conversely, "*" disappeared.
DIMMER
LeadingEdge TrailingEdge Off
- Press **Esc** to quit the menu.

DIMMER

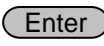
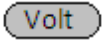
LeadingEdge TrailingEdge Off

> Set phase angle and start test



1. Press compound key  (Shift)+  (*Dimmer) and enter menu operation
Off *
0.0V 0.0mA 50.0
0.00W PF=0.000 0.0S
2. Press numeric key to set angle, press  to confirm. Also you can adjust angle by knob to view real-time waveform changes along.
Off *
0.0V 0.0mA 50.0
Dimmer=30.0° 0.1S
3. Press  and numeric key to set voltage based on requirement. Press  to confirm.
Off *
0.0V 0.0mA 50.0
0.00W PF=0.000 0.0S
4. Confirm that both List and Sweep are in Disable status (VFD appears no words of List or Sweep). Press  to turn on Output. The power supply starts outputting phase dimmer wave, and the “*” on VFD flicks. Press  again to stop output.
Off *
0.0V 0.0mA 50.0
0.00W PF=0.000 0.0S

3.11 Output Range

IT7300 series AC source will allow switchover between High range and Auto range. Take IT7321 as example, the voltage, current and apparent power at the High range is 300V/1.5A/300VA; the voltage, current and apparent power at the Low range is 150V/3A/300VA. Auto range refers to auto switchover mode between High range and Low range.

You can choose the range according to actual test requirements. When Auto range is chosen, the switchover between High range and Low range will be performed by the instrument automatically, thus sparing complicated operations such as manual setting.

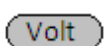
Switch High range and Auto range:

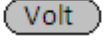
Press  (Shift) and  (High/Auto) together to switch between High range and Auto range. When High range is chosen, press the  (Shift) and  (High/Auto) together to switch to Auto range. The indicator “Auto” on the VFD will be on.





Note

There is a temporary OFF to the AC source during the switchover of range.

3.12 Key Lock

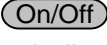
The front panel keys can be locked to prevent unwanted changes to output settings and AC source configurations. Follow the steps below to enable/disable key lock.

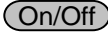
Press  (Shift)+  (Lock) button to set the key lock state. If keyboard has been locked, the indicator light "Lock" will display on the VFD. In addition, when keyboard is locked, all buttons can't be used except ON/OFF key, Shift key and Select key. Press  (Shift)+  (Lock) once again will relieve key lock function.

OFF	0.0V	0.0mA	50.0
0.00W		PF=0.000	Lock

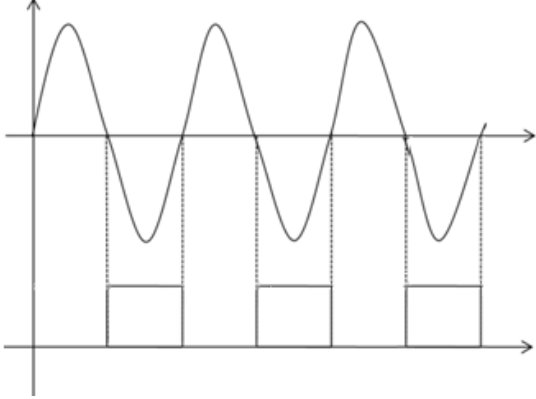

3.13 BNC

There is a composite terminal at the rear panel of the AC source (see description of rear panel), which can be used as:

Input signal:	
I-Trigger	Serve as input signal by external trigger. Connect the positive and negative end of the terminal to generate a trigger signal. To use this function, you need to set the Trigger item under System menu to Extern (External Trigger).
I-Ri	Serve as the control signal for On/Off. When the positive and negative end of the terminal is in short circuit, the status of AC source is OFF; when the circuit is open, the status of AC source is ON. Note: Only when the front panel and BNC are set to On at the same time, the power supply outputs. Otherwise, the power supply is OFF.
Output signal:	
O-Sync	as synchronizing signal of alternating phase: 
O-On	as status signal for On/Off. When the status of AC source

	is ON, the terminal will output high level; when the status of power supply is OFF, the terminal will output low level
--	--

Before using BNC terminal, you need to define its function firstly by following steps below:

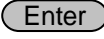
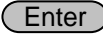
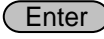
1. Press multiple key  (Shift)+  (Menu) to menu operation.
Off
0.0V 0.0mA 50.0
0.00W PF=0.000 0.0S
2. Press right arrow key and select “config”, press  key when “Config” is shining.
MENU
System Config Info
3. Press right arrow key to BNC-Set and press  key when “BNC-Set” is shining.
CONFIG
V-Min V-Max >
4. Press left and right arrow keys to select interface function and press . Press ESC key to exit menu.
BNC PORT SETUP
I-Trigger I-Ri O-Sync O-On >

3.14 3ø-Setup

IT7322/IT7322H/IT7324/IT7324H/IT7326/IT7326H supports 3-phase output via three units. The three units need to be connected together via SYSTEM BUS to achieve 3-phase output function of AC power supply.

The IT7322T, IT7322HT, IT7324T, IT7324HT, IT7326T and IT7326HT can output the three-phase AC power source and are assembled by three single-phase instruments. Furthermore, the three single-phase instruments of the three-phase power supply are set to Phase A, Phase B and Phase C before shipment. Therefore, the following operations don't apply to the three-phase power supplies.



NOTE

After being assembled into three-phase, the **List** and **Sweep** functions will not be available.

Take IT7324 as example for description. 3-phase output includes two connection types of “Y” or “Delta”.

- **Y type connection:**

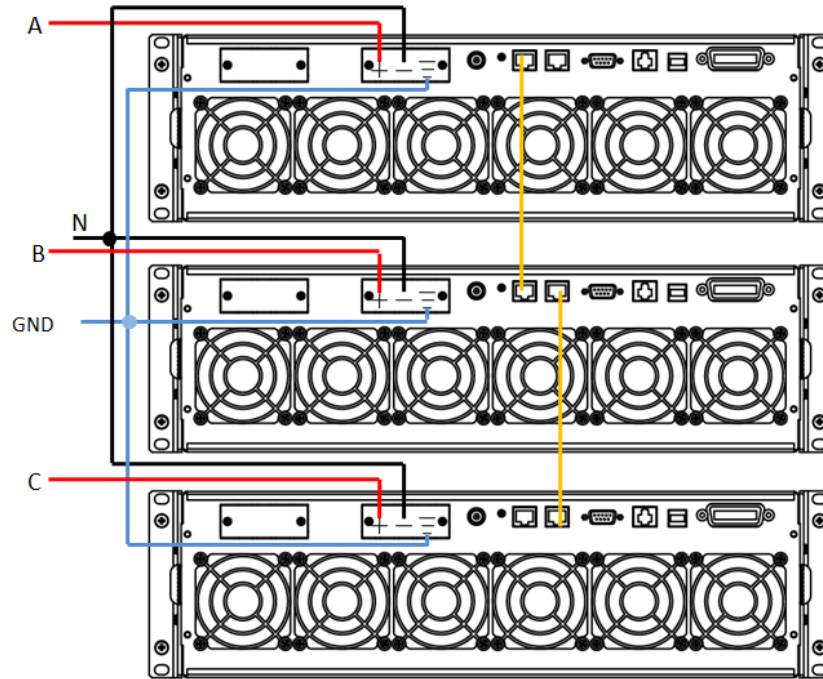

- **Delta connection:**

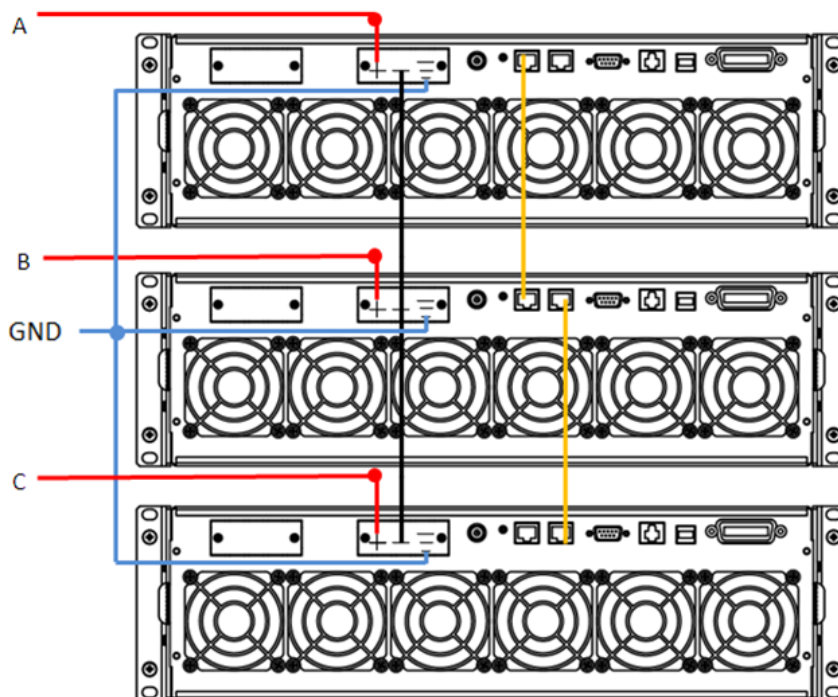

SYSTEM BUS: User need to connect three units together via a straight network cable. Please see figure above.

Select one connection method as shown above. After wiring, set 3 power supplies to Phase A, Phase B and Phase C respectively. Phase A power supply will automatically search for Phase B and Phase C power supplies. Detailed operation steps are shown below:

Set Phase A

1. Press  (Shift)+  (Menu) to enter the menu operation.

- Press right-key to select CONFIG, then press **Enter** button to confirm.
- Press left and right arrow keys to select 3 \emptyset -Setup. Press **Enter** to enter configuration of 3-phase AC power supply function. Interface displays as below:



Two parameters need to be set from the menu to enable this function:

- | | |
|----------------------------|---------------------------------------|
| A-Phase/ B-Phase / C-Phase | Configure the phase line of each unit |
| Disable/Enable | Turn on or turn off 3-phase function |
- Press right key to select item to be set and press Up/Down key to select.
- After setting of Phase A, press [Esc] to return to the Main Interface, which displays as follows:

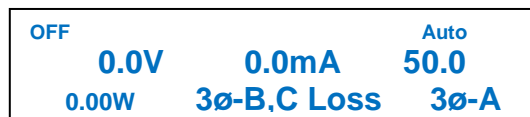

Set Phase B/C

Follow same setting steps 1-3 of Phase A to set Phase B/C. After setting of Phase B/C, press [Esc] to return to the Main Interface. Take Main Interface of Phase B as example, as shown below.

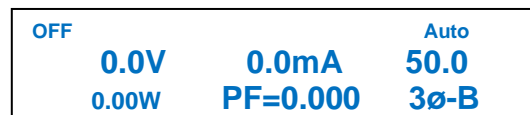

After setting of Phases B and C, the main interface of Phase A power supply displays as follows:

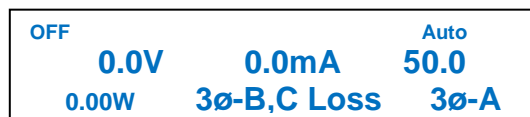

Note

When you operate the instrument which is set to Phase A, the other two instruments will execute the same operation.

Chapter4 Specification

This chapter will introduce the main technical parameters of IT7300, such as rated voltage/current/power and so on. Besides, this part will introduce the working environment and storage temperature.

4.1 Specification

Model		IT7321
INPUT		
Phase		1
Voltage		220Vac±10% or 110Vac±10%
Frequency		47-63Hz
Max.Current		6.3A(220Vac) or 10A(110Vac)
Power Factor		0.5(typical)
AC OUTPUT		
Max.Power		300VA
Max Current(rms)	0-150V	3A
	0-300V	1.5A
Max Current(peak)	0-150V	9A
	0-300V	4.5A
Phase		1Φ/2W
Total Harmonic Distortion(T.H.D)		≤0.5% at 45-500Hz (Resistive Load)
Crest Factor		3
Line Regulation		0.1% max for a ±10% line change
Load Regulation		≤0.5%FS(Resistive Load)
Response Time		<100uS
SETTING		
Voltage	Range	0-300V High, 150/300V Auto
	Resolution	0.1V
	Accuracy	±(0.2%+0.6V)
	Temp. coefficient	±(0.04% per degree from 25°C)
Frequency	Range	45-500Hz
	Resolution	0.1Hz at 45-99.9Hz 1Hz at 100-500Hz
	Accuracy	0.1Hz
Phase Angle	Range	0-360°
	Resolution	0.1°
	Accuracy	±1°(45-65Hz)
MEASUREMENT		
Voltage(rms)	Range	0-300V

	Resolution	0.1V
	Accuracy	$\pm(0.2\%+0.6V)$
	Temp. coefficient	$\pm(0.04\%$ per degree from 25°C)
Current(rms)	Range	L:120.0mA *
		M:1.200A *
		H:3.00A *
	Resolution	L:0.1mA
		M:1mA
		H:10mA
Accuracy	L: $\pm(0.2\%+0.6mA)$	
	M: $\pm(0.2\%+6mA)$	
	H: $\pm(0.2\%+40mA)$	
Temp. coefficient	$\pm(0.04\%$ per degree from 25°C)	
Current(peak)	Range	0-12A
	Resolution	0.01A
	Accuracy	$\pm(1\%+0.36A)$
	Temp. coefficient	$\pm(0.05\%$ per degree from 25°C)
Power	Resolution	L:0.01W
		M:0.1W
		H:1W
	Accuracy	L: $\pm(0.2\%+0.2W)$ (47HZ-65HZ)
		M: $\pm(0.2\%+2W)$ (47HZ-65HZ)
H: $\pm(0.2\%+4W)$ (47HZ-65HZ)		
Temp. coefficient	$\pm(0.05\%$ per degree from 25°C)	
GENERAL		
Memory	10 memories	
Sync Output Signal	Output Signal 5V,BNC type	
Interface	LAN,USB,RS232	
Operation Environment	0-40°C/20-80%RH	
Dimension	1/2 19" 2U	
Weight	10Kg	

Model	IT7322
INPUT	
Phase	1
Voltage	220Vac \pm 10% or 110Vac \pm 10%
Frequency	47-63Hz
Max.Current	15A(220Vac) or 30A(110Vac)
Power Factor	0.7(typical)
AC OUTPUT	
Max.Power	750VA

Max Current(rms)	0-150V	6A
	0-300V	3A
Max Current(peak)	0-150V	18A
	0-300V	9A
Phase		1 Φ /2W
Total Harmonic Distortion(T.H.D)		$\leq 0.5\%$ at 45-500Hz (Resistive Load)
Crest Factor		3
Line Regulation		0.1% max for a $\pm 10\%$ line change
Load Regulation		$\leq 0.5\%$ FS(Resistive Load)
Response Time		<100 μ S
SETTING		
Voltage	Range	0-300V High, 150/300V Auto
	Resolution	0.1V
	Accuracy	$\pm(0.2\%+0.6V)$
	Temp. coefficient	$\pm(0.04\%$ per degree from 25°C)
Frequency	Range	45-500Hz
	Resolution	0.1Hz at 45-99.9Hz 1Hz at 100-500Hz
	Accuracy	0.1Hz
Phase Angle	Range	0-360°
	Resolution	0.1°
	Accuracy	$\pm 1^\circ$ (45-65Hz)
MEASUREMENT		
Voltage(rms)	Range	0-300V
	Resolution	0.1V
	Accuracy	$\pm(0.2\%+0.6V)$
	Temp. coefficient	$\pm(0.04\%$ per degree from 25°C)
Current(rms)	Range	L:120.0mA *
		M:1.200A *
		H:6.00A *
	Resolution	L:0.1mA
		M:1mA
		H:10mA
Accuracy	L: $\pm(0.2\%+0.6mA)$	
	M: $\pm(0.2\%+6mA)$	
	H: $\pm(0.2\%+60mA)$	
Temp. coefficient	$\pm(0.04\%$ per degree from 25°C)	
Current(peak)	Range	0-18A
	Resolution	0.01A
	Accuracy	$\pm(1\%+0.36A)$
	Temp. coefficient	$\pm(0.05\%$ per degree from 25°C)
Power	Resolution	L:0.01W
		M:0.1W
		H:1W
Accuracy	L: $\pm(0.2\%+0.2W)$ (47HZ-65HZ)	

		M:±(0.2%+2W) (47HZ-65HZ)
		H:±(0.2%+6W) (47HZ-65HZ)
	Temp. coefficient	±(0.05% per degree from 25°C)
GENERAL		
Memory	10 memories	
Sync Output Signal	Output Signal 5V,BNC type	
Interface	LAN,USB,RS232	
Operation Environment	0-40°C/20-80%RH	
Dimension	19" 3U	
Weight	37Kg	

Model		IT7322H
INPUT		
Phase	1	
Voltage	220Vac±10% or 110Vac±10%	
Frequency	47-63Hz	
Max.Current	20A(220Vac) or 40A(110Vac)	
Power Factor	0.7(typical)	
AC OUTPUT		
Max.Power	750VA	
Max Current(rms)	0-250V	3A
	0-500V	1.5A
Max Current(peak)	0-250V	9A
	0-500V	4.5A
Phase	1Φ/2W	
Total Harmonic Distortion(T.H.D)	≤1% at 45-500Hz (Resistive Load)	
Crest Factor	≤3	
Line Regulation	0.1% max for a ±10% line change	
Load Regulation	≤0.5%FS(Resistive Load)	
Response Time	<100uS	
SETTING		
Voltage	Range	0-500V High, 250/500V Auto
	Resolution	0.1V
	Accuracy	±(0.2%+1.2V)
	Temp. coefficient	±(0.04% per degree from 25°C)
Frequency	Range	45-500Hz
	Resolution	0.1Hz at 45-99.9Hz 1Hz at 100-500Hz
	Accuracy	0.1Hz
Phase Angle	Range	0-360°
	Resolution	0.1°

	Accuracy	$\pm 1^\circ$ (45-65Hz)
MEASUREMENT		
Voltage(rms)	Range	0-500V
	Resolution	0.1V
	Accuracy	$\pm(0.2\%+1.2V)$
	Temp. coefficient	$\pm(0.04\%$ per degree from 25°C)
Current(rms)	Range	L:120.0mA *
		M:1.200A *
		H:3.00A *
	Resolution	L:0.1mA
		M:1mA
		H:10mA
	Accuracy	L: $\pm(0.2\%+0.6mA)$
M: $\pm(0.2\%+6mA)$		
H: $\pm(0.2\%+40mA)$		
Temp. coefficient	$\pm(0.04\%$ per degree from 25°C)	
Current(peak)	Range	0-9A
	Resolution	0.01A
	Accuracy	$\pm(1\%+0.36A)$
	Temp. coefficient	$\pm(0.05\%$ per degree from 25°C)
Power	Resolution	L:0.01W
		M:0.1W
		H:1W
	Accuracy	L: $\pm(0.2\%+0.2W)$ (47HZ-65HZ)
		M: $\pm(0.2\%+2W)$ (47HZ-65HZ)
Temp. coefficient	H: $\pm(0.2\%+6W)$ (47HZ-65HZ)	
		$\pm(0.05\%$ per degree from 25°C)
GENERAL		
Memory		10 memories
Sync Output Signal		Output Signal 5V,BNC type
Interface		LAN,USB,RS232
Operation Environment		0-40°C/20-80%RH
Dimension		19" 3U
Weight		37Kg

Model	IT7324
INPUT	
Phase	1
Voltage	220Vac $\pm 10\%$ or 110Vac $\pm 10\%$
Frequency	47-63Hz
Max.Current	30A(220Vac) or 60A(110Vac)

Power Factor	0.7(typical)	
AC OUTPUT		
Max.Power	1500VA	
Max Current(rms)	0-150V	12A
	0-300V	6A
Max Current(peak)	0-150V	36A
	0-300V	18A
Phase	1 Φ /2W	
Total Harmonic Distortion(T.H.D)	$\leq 0.5\%$ at 45-500Hz (Resistive Load)	
Crest Factor	3	
Line Regulation	0.1% max for a $\pm 10\%$ line change	
Load Regulation	$\leq 0.5\%$ FS(Resistive Load)	
Response Time	<100uS	
SETTING		
Voltage	Range	0-300V High, 150/300V Auto
	Resolution	0.1V
	Accuracy	$\pm(0.2\%+0.6V)$
	Temp. coefficient	$\pm(0.04\%$ per degree from 25°C)
Frequency	Range	45-500Hz
	Resolution	0.1Hz at 45-99.9Hz 1Hz at 100-500Hz
	Accuracy	0.1Hz
Phase Angle	Range	0-360°
	Resolution	0.1°
	Accuracy	$\pm 1^\circ$ (45-65Hz)
MEASUREMENT		
Voltage(rms)	Range	0-300V
	Resolution	0.1V
	Accuracy	$\pm(0.2\%+0.6V)$
	Temp. coefficient	$\pm(0.04\%$ per degree from 25°C)
Current(rms)	Range	L:120.0mA *
		M:1.200A *
		H:12.00A *
	Resolution	L:0.1mA
		M:1mA
		H:10mA
	Accuracy	L: $\pm(0.2\%+0.6mA)$
M: $\pm(0.2\%+6mA)$		
H: $\pm(0.2\%+80mA)$		
Temp. coefficient	$\pm(0.04\%$ per degree from 25°C)	
Current(peak)	Range	0-48A
	Resolution	0.01A
	Accuracy	$\pm(1\%+0.36A)$

	Temp. coefficient	$\pm(0.05\%$ per degree from 25°C)
Power	Resolution	L:0.01W
		M:0.1W
		H:1W
	Accuracy	L: $\pm(0.2\%+0.2W)$ (47HZ-65HZ)
M: $\pm(0.2\%+2W)$ (47HZ-65HZ)		
		H: $\pm(0.2\%+10W)$ (47HZ-65HZ)
	Temp. coefficient	$\pm(0.05\%$ per degree from 25°C)
GENERAL		
Memory		10 memories
Sync Output Signal		Output Signal 5V,BNC type
Interface		LAN,USB,RS232
Operation Environment		0-40°C/20-80%RH
Dimension		19" 3U
Weight		48Kg

Model		IT7324H
INPUT		
Phase		1
Voltage		220Vac \pm 10% or 110Vac \pm 10%
Frequency		47-63Hz
Max.Current		30A(220Vac) or 60A(110Vac)
Power Factor		0.7(typical)
AC OUTPUT		
Max.Power		1500VA
Max Current(rms)	0-250V	6A
	0-500V	3A
Max Current(peak)	0-250V	18A
	0-500V	9A
Phase		1 Φ /2W
Total Harmonic Distortion(T.H.D)		\leq 1% at 45-500Hz (Resistive Load)
Crest Factor		3
Line Regulation		0.1% max for a \pm 10% line change
Load Regulation		\leq 0.5%FS(Resistive Load)
Response Time		<100uS
SETTING		
Voltage	Range	0-500V High, 250/500V Auto
	Resolution	0.1V
	Accuracy	$\pm(0.2\%+1.2V)$

	Temp. coefficient	$\pm(0.04\%$ per degree from 25°C)
Frequency	Range	45-500Hz
	Resolution	0.1Hz at 45-99.9Hz 1Hz at 100-500Hz
	Accuracy	0.1Hz
Phase Angle	Range	0-360°
	Resolution	0.1°
	Accuracy	$\pm 1^\circ(45-65\text{Hz})$
MEASUREMENT		
Voltage(rms)	Range	0-500V
	Resolution	0.1V
	Accuracy	$\pm(0.2\%+1.2\text{V})$
	Temp. coefficient	$\pm(0.04\%$ per degree from 25°C)
Current(rms)	Range	L:120.0mA *
		M:1.200A *
		H:6.00A *
	Resolution	L:0.1mA
		M:1mA
		H:10mA
Accuracy	L: $\pm(0.2\%+0.6\text{mA})$	
	M: $\pm(0.2\%+6\text{mA})$	
	H: $\pm(0.2\%+60\text{mA})$	
Temp. coefficient	$\pm(0.04\%$ per degree from 25°C)	
Current(peak)	Range	0-24A
	Resolution	0.01A
	Accuracy	$\pm(1\%+0.36\text{A})$
	Temp. coefficient	$\pm(0.05\%$ per degree from 25°C)
Power	Resolution	L:0.01W
		M:0.1W
		H:1W
	Accuracy	L: $\pm(0.2\%+0.2\text{W})$ (47HZ-65HZ)
		M: $\pm(0.2\%+2\text{W})$ (47HZ-65HZ)
Temp. coefficient	H: $\pm(0.2\%+10\text{W})$ (47HZ-65HZ)	
GENERAL		
Memory	10 memories	
Sync Output Signal	Output Signal 5V,BNC type	
Interface	LAN,USB,RS232	
Operation Environment	0-40°C/20-80%RH	
Dimension	19" 3U	
Weight	37Kg	
Model	IT7326	
INPUT		

Phase	1	
Voltage	220Vac±10%	
Frequency	47-63Hz	
Max.Current	60A	
Power Factor	0.7(typical)	
AC OUTPUT		
Max.Power	3000VA	
Max Current(rms)	0-150V	24A
	0-300V	12A
Max Current(peak)	0-150V	72A
	0-300V	36A
Phase	1Φ/2W	
Total Harmonic Distortion(T.H.D)	≤0.5% at 45-500Hz (Resistive Load)	
Crest Factor	3	
Line Regulation	0.1% max for a ±10% line change	
Load Regulation	≤0.5%FS(Resistive Load)	
Response Time	<100uS	
SETTING		
Voltage	Range	0-300V High, 150/300V Auto
	Resolution	0.1V
	Accuracy	±(0.2%+0.6V)
	Temp. coefficient	±(0.04% per degree from 25°C)
Frequency	Range	45-500Hz
	Resolution	0.1Hz at 45-99.9Hz 1Hz at 100-500Hz
	Accuracy	0.1Hz
Phase Angle	Range	0-360°
	Resolution	0.1°
	Accuracy	±1°(45-65Hz)
MEASUREMENT		
Voltage(rms)	Range	0-300V
	Resolution	0.1V
	Accuracy	±(0.2%+0.6V)
	Temp. coefficient	±(0.04% per degree from 25°C)
Current(rms)	Range	L:120.0mA *
		M:1.200A *
		H:24.00A *
	Resolution	L:0.1mA
		M:1mA
		H:10mA
	Accuracy	L:±(0.2%+0.6mA)
M:±(0.2%+6mA)		
H:±(0.2%+0.1A)		
Temp. coefficient	±(0.04% per degree from 25°C)	

Current(peak)	Range	0-96A
	Resolution	0.01A
	Accuracy	$\pm(1\%+0.36A)$
	Temp. coefficient	$\pm(0.05\%$ per degree from 25°C)
Power	Resolution	L:0.01W
		M:0.1W
		H:1W
	Accuracy	L: $\pm(0.2\%+0.2W)$ (47HZ-65HZ)
		M: $\pm(0.2\%+2W)$ (47HZ-65HZ)
Temp. coefficient	H: $\pm(0.2\%+15W)$ (47HZ-65HZ)	
Temp. coefficient	$\pm(0.05\%$ per degree from 25°C)	
GENERAL		
Memory	10 memories	
Sync Output Signal	Output Signal 5V,BNC type	
Interface	LAN,USB,RS232	
Operation Environment	0-40°C/20-80%RH	
Dimension	19" 6U	
Weight	103Kg	

Model		IT7326H
INPUT		
Phase	1	
Voltage	220Vac \pm 10%	
Frequency	47-63Hz	
Max.Current	60A	
Power Factor	0.7(typical)	
AC OUTPUT		
Max.Power	3000VA	
Max Current(rms)	0-250V	12A
	0-500V	6A
Max Current(peak)	0-250V	36A
	0-500V	18A
Phase	1 Φ /2W	
Total Harmonic Distortion(T.H.D)	\leq 1% at 45-500Hz (Resistive Load)	
Crest Factor	3	
Line Regulation	0.1% max for a \pm 10% line change	
Load Regulation	\leq 0.5%FS(Resistive Load)	
Response Time	<100uS	

SETTING		
Voltage	Range	0-500V High, 250/500V Auto
	Resolution	0.1V
	Accuracy	$\pm(0.2\%+1.2V)$
	Temp. coefficient	$\pm(0.04\%$ per degree from 25°C)
Frequency	Range	45-500Hz
	Resolution	0.1Hz at 45-99.9Hz 1Hz at 100-500Hz
	Accuracy	0.1Hz
Phase Angle	Range	0-360°
	Resolution	0.1°
	Accuracy	$\pm 1^\circ(45-65Hz)$
MEASUREMENT		
Voltage(rms)	Range	0-500V
	Resolution	0.1V
	Accuracy	$\pm(0.2\%+1.2V)$
	Temp. coefficient	$\pm(0.04\%$ per degree from 25°C)
Current(rms)	Range	L:120.0mA *
		M:1.200A *
		H:12.00A *
	Resolution	L:0.1mA
		M:1mA
		H:10mA
Accuracy	L: $\pm(0.2\%+0.6mA)$	
	M: $\pm(0.2\%+6mA)$	
	H: $\pm(0.2\%+60mA)$	
Temp. coefficient	$\pm(0.04\%$ per degree from 25°C)	
Current(peak)	Range	0-48A
	Resolution	0.01A
	Accuracy	$\pm(1\%+0.36A)$
	Temp. coefficient	$\pm(0.05\%$ per degree from 25°C)
Power	Resolution	L:0.01W
		M:0.1W
		H:1W
	Accuracy	L: $\pm(0.2\%+0.2W)$ (47HZ-65HZ)
		M: $\pm(0.2\%+2W)$ (47HZ-65HZ)
Temp. coefficient	H: $\pm(0.2\%+10W)$ (47HZ-65HZ)	
Temp. coefficient	$\pm(0.05\%$ per degree from 25°C)	
GENERAL		
Memory	10 memories	
Sync Output Signal	Output Signal 5V,BNC type	
Interface	LAN,USB,RS232	
Operation Environment	0-40°C/20-80%RH	
Dimension	19" 6U	
Weight	103Kg	

Model		IT7322T
INPUT		
Phase		3
Voltage		380Vac±10%(Y)
Frequency		47-63Hz
Max.Current		15A
Power Factor		0.7(typical)
AC OUTPUT		
Max.Power		2250VA
Max Current(rms)	0-150V	6A
	0-300V	3A
Max Current(peak)	0-150V	18A
	0-300V	9A
Phase		3φ
Total Harmonic Distortion(T.H.D)		≤0.5% at 45-500Hz (Resistive Load)
Crest Factor		3
Line Regulation		0.1% max for a ±10% line change
Load Regulation		≤0.5%FS(Resistive Load)
Response Time		<100uS
SETTING		
Voltage	Range	0-300V High, 150/300V Auto
	Resolution	0.1V
	Accuracy	±(0.2%+0.6V)
	Temp. coefficient	±(0.04% per degree from 25°C)
Frequency	Range	45-500Hz
	Resolution	0.1Hz at 45-99.9Hz 1Hz at 100-500Hz
	Accuracy	0.1Hz
MEASUREMENT		
Voltage(rms)	Range	0-300V
	Resolution	0.1V
	Accuracy	±(0.2%+0.6V)
	Temp. coefficient	±(0.04% per degree from 25°C)
Current(rms)	Range	L:120.0mA *
		M:1.200A *
		H:6.00A *
	Resolution	L:0.1mA
		M:1mA
		H:10mA
Accuracy	L:±(0.2%+0.6mA)	
	M:±(0.2%+6mA)	

		H:±(0.2%+0.1A)
	Temp. coefficient	±(0.04% per degree from 25°C)
Current(peak)	Range	0-18A
	Resolution	0.01A
	Accuracy	±(1%+0.36A)
	Temp. coefficient	±(0.05% per degree from 25°C)
Power	Resolution	L:0.01W
		M:0.1W
		H:1W
	Accuracy	L:±(0.2%+0.2W) (47HZ-65HZ)
		M:±(0.2%+2W) (47HZ-65HZ)
Temp. coefficient	H:±(0.2%+15W) (47HZ-65HZ)	
		±(0.05% per degree from 25°C)
GENERAL		
Memory		10 memories
Sync Output Signal		Output Signal 5V,BNC type
Interface		LAN,USB,RS232
Operation Environment		0-40°C/20-80%RH
Dimension		15U
Weight		150Kg

Model		IT7322HT
INPUT		
Phase		3
Voltage		380Vac±10%(Y)
Frequency		47-63Hz
Max.Current		15A
Power Factor		0.7(typical)
AC OUTPUT		
Max.Power		2250VA
Max Current(rms)	0-250V	3A
	0-500V	1.5A
Max Current(peak)	0-250V	9A
	0-500V	4.5A
Phase		3φ
Total Harmonic Distortion(T.H.D)		≤1% at 45-500Hz (Resistive Load)
Crest Factor		3
Line Regulation		0.1% max for a ±10% line change
Load Regulation		≤0.5%FS(Resistive Load)

Response Time	<100uS	
SETTING		
Voltage	Range	0-500V High, 250/500V Auto
	Resolution	0.1V
	Accuracy	$\pm(0.2\%+1.2V)$
	Temp. coefficient	$\pm(0.04\%$ per degree from 25°C)
Frequency	Range	45-500Hz
	Resolution	0.1Hz at 45-99.9Hz 1Hz at 100-500Hz
	Accuracy	0.1Hz
MEASUREMENT		
Voltage(rms)	Range	0-500V
	Resolution	0.1V
	Accuracy	$\pm(0.2\%+1.2V)$
	Temp. coefficient	$\pm(0.04\%$ per degree from 25°C)
Current(rms)	Range	L:120.0mA *
		M:1.200A *
		H:3.00A *
	Resolution	L:0.1mA
		M:1mA
		H:10mA
	Accuracy	L: $\pm(0.2\%+0.6mA)$
M: $\pm(0.2\%+6mA)$		
H: $\pm(0.2\%+60mA)$		
Temp. coefficient	$\pm(0.04\%$ per degree from 25°C)	
Current(peak)	Range	0-9A
	Resolution	0.01A
	Accuracy	$\pm(1\%+0.36A)$
	Temp. coefficient	$\pm(0.05\%$ per degree from 25°C)
Power	Resolution	L:0.01W
		M:0.1W
		H:1W
	Accuracy	L: $\pm(0.2\%+0.2W)$ (47HZ-65HZ)
		M: $\pm(0.2\%+2W)$ (47HZ-65HZ)
Temp. coefficient	H: $\pm(0.2\%+10W)$ (47HZ-65HZ)	
GENERAL		
Memory	10 memories	
Sync Output Signal	Output Signal 5V,BNC type	
Interface	LAN,USB,RS232	
Operation Environment	0-40°C/20-80%RH	
Dimension	15U	
Weight	150Kg	

Model		IT7324T
INPUT		
Phase		3
Voltage		380Vac±10%(Y)
Frequency		47-63Hz
Max.Current		30A
Power Factor		0.7(typical)
AC OUTPUT		
Max.Power		4500VA
Max Current(rms)	0-150V	12A
	0-300V	6A
Max Current(peak)	0-150V	36A
	0-300V	18A
Phase		3 φ
Total Harmonic Distortion(T.H.D)		≤0.5% at 45-500Hz (Resistive Load)
Crest Factor		3
Line Regulation		0.1% max for a ±10% line change
Load Regulation		≤0.5%FS(Resistive Load)
Response Time		<100uS
SETTING		
Voltage	Range	0-300V High, 150/300V Auto
	Resolution	0.1V
	Accuracy	±(0.2%+0.6V)
	Temp. coefficient	±(0.04% per degree from 25°C)
Frequency	Range	45-500Hz
	Resolution	0.1Hz at 45-99.9Hz 1Hz at 100-500Hz
	Accuracy	0.1Hz
MEASUREMENT		
Voltage(rms)	Range	0-300V
	Resolution	0.1V
	Accuracy	±(0.2%+0.6V)
	Temp. coefficient	±(0.04% per degree from 25°C)
Current(rms)	Range	L:120.0mA *
		M:1.200A *
		H:12.00A *
	Resolution	L:0.1mA
		M:1mA
		H:10mA
Accuracy	L:±(0.2%+0.6mA)	
	M:±(0.2%+6mA)	

		H: $\pm(0.2\%+0.1A)$
	Temp. coefficient	$\pm(0.04\%$ per degree from 25°C)
Current(peak)	Range	0-36A
	Resolution	0.01A
	Accuracy	$\pm(1\%+0.36A)$
	Temp. coefficient	$\pm(0.05\%$ per degree from 25°C)
Power	Resolution	L:0.01W
		M:0.1W
		H:1W
	Accuracy	L: $\pm(0.2\%+0.2W)$ (47HZ-65HZ)
		M: $\pm(0.2\%+2W)$ (47HZ-65HZ)
Temp. coefficient	H: $\pm(0.2\%+15W)$ (47HZ-65HZ)	
		$\pm(0.05\%$ per degree from 25°C)
GENERAL		
Memory		10 memories
Sync Output Signal		Output Signal 5V,BNC type
Interface		LAN,USB,RS232
Operation Environment		0-40°C/20-80%RH
Dimension		15U
Weight		201Kg

Model	IT7324HT	
INPUT		
Phase	3	
Voltage	380Vac \pm 10%(Y)	
Frequency	47-63Hz	
Max.Current	30A	
Power Factor	0.7(typical)	
AC OUTPUT		
Max.Power	4500VA	
Max Current(rms)	0-250V	6A
	0-500V	3A
Max Current(peak)	0-250V	18A
	0-500V	9A
Phase	3 ϕ	
Total Harmonic Distortion(T.H.D)	\leq 1% at 45-500Hz (Resistive Load)	
Crest Factor	3	
Line Regulation	0.1% max for a \pm 10% line change	

Load Regulation		$\leq 0.5\%FS$ (Resistive Load)
Response Time		<100uS
SETTING		
Voltage	Range	0-500V High, 250/500V Auto
	Resolution	0.1V
	Accuracy	$\pm(0.2\%+1.2V)$
	Temp. coefficient	$\pm(0.04\%$ per degree from 25°C)
Frequency	Range	45-500Hz
	Resolution	0.1Hz at 45-99.9Hz 1Hz at 100-500Hz
	Accuracy	0.1Hz
MEASUREMENT		
Voltage(rms)	Range	0-500V
	Resolution	0.1V
	Accuracy	$\pm(0.2\%+1.2V)$
	Temp. coefficient	$\pm(0.04\%$ per degree from 25°C)
Current(rms)	Range	L:120.0mA *
		M:1.200A *
		H:6.00A *
	Resolution	L:0.1mA
		M:1mA
		H:10mA
Accuracy	L: $\pm(0.2\%+0.6mA)$	
	M: $\pm(0.2\%+6mA)$	
	H: $\pm(0.2\%+60mA)$	
Temp. coefficient	$\pm(0.04\%$ per degree from 25°C)	
Current(peak)	Range	0-18A
	Resolution	0.01A
	Accuracy	$\pm(1\%+0.36A)$
	Temp. coefficient	$\pm(0.05\%$ per degree from 25°C)
Power	Resolution	L:0.01W
		M:0.1W
		H:1W
	Accuracy	L: $\pm(0.2\%+0.2W)$ (47HZ-65HZ)
M: $\pm(0.2\%+2W)$ (47HZ-65HZ)		
H: $\pm(0.2\%+10W)$ (47HZ-65HZ)		
Temp. coefficient	$\pm(0.05\%$ per degree from 25°C)	
GENERAL		
Memory		10 memories
Sync Output Signal		Output Signal 5V,BNC type
Interface		LAN,USB,RS232
Operation Environment		0-40°C/20-80%RH

Dimension	15U
Weight	201Kg

Model		IT7326T
INPUT		
Phase		3
Voltage		380Vac \pm 10%(Y)
Frequency		47-63Hz
Max.Current		60A
Power Factor		0.7(typical)
AC OUTPUT		
Max.Power		9000VA
Max Current(rms)	0-150V	24A
	0-300V	12A
Max Current(peak)	0-150V	72A
	0-300V	36A
Phase		3 ϕ
Total Harmonic Distortion(T.H.D)		\leq 0.5% at 45-500Hz (Resistive Load)
Crest Factor		3
Line Regulation		0.1% max for a \pm 10% line change
Load Regulation		\leq 0.5%FS(Resistive Load)
Response Time		<100uS
SETTING		
Voltage	Range	0-300V High, 150/300V Auto
	Resolution	0.1V
	Accuracy	\pm (0.2%+0.6V)
	Temp. coefficient	\pm (0.04% per degree from 25°C)
Frequency	Range	45-500Hz
	Resolution	0.1Hz at 45-99.9Hz 1Hz at 100-500Hz
	Accuracy	0.1Hz
MEASUREMENT		
Voltage(rms)	Range	0-300V
	Resolution	0.1V
	Accuracy	\pm (0.2%+0.6V)
	Temp. coefficient	\pm (0.04% per degree from 25°C)
Current(rms)	Range	L:120.0mA *
		M:1.200A *
		H:24.00A *
Resolution	L:0.1mA	

	Accuracy	M:1mA
		H:10mA
		L: $\pm(0.2\%+0.6\text{mA})$
		M: $\pm(0.2\%+6\text{mA})$
		H: $\pm(0.2\%+0.1\text{A})$
	Temp. coefficient	$\pm(0.04\%$ per degree from 25°C)
Current(peak)	Range	0-72A
	Resolution	0.01A
	Accuracy	$\pm(1\%+0.36\text{A})$
	Temp. coefficient	$\pm(0.05\%$ per degree from 25°C)
Power	Resolution	L:0.01W
		M:0.1W
		H:1W
	Accuracy	L: $\pm(0.2\%+0.2\text{W})$ (47HZ-65HZ)
		M: $\pm(0.2\%+2\text{W})$ (47HZ-65HZ)
	H: $\pm(0.2\%+15\text{W})$ (47HZ-65HZ)	
	Temp. coefficient	$\pm(0.05\%$ per degree from 25°C)
GENERAL		
Memory	10 memories	
Sync Output Signal	Output Signal 5V,BNC type	
Interface	LAN,USB,RS232	
Operation Environment	0-40°C/20-80%RH	
Dimension	27U	
Weight	396Kg	

Model	IT7326HT	
INPUT		
Phase	3	
Voltage	380Vac \pm 10%(Y)	
Frequency	47-63Hz	
Max.Current	60A	
Power Factor	0.7(typical)	
AC OUTPUT		
Max.Power	9000VA	
Max Current(rms)	0-250V	12A
	0-500V	6A
Max Current(peak)	0-250V	36A
	0-500V	18A
Phase	3 ϕ	

Total Harmonic Distortion(T.H.D)		$\leq 1\%$ at 45-500Hz (Resistive Load)
Crest Factor		3
Line Regulation		0.1% max for a $\pm 10\%$ line change
Load Regulation		$\leq 0.5\%$ FS(Resistive Load)
Response Time		<100uS
SETTING		
Voltage	Range	0-500V High, 250/500V Auto
	Resolution	0.1V
	Accuracy	$\pm (0.2\%+1.2V)$
	Temp. coefficient	$\pm (0.04\%$ per degree from 25°C)
Frequency	Range	45-500Hz
	Resolution	0.1Hz at 45-99.9Hz 1Hz at 100-500Hz
	Accuracy	0.1Hz
MEASUREMENT		
Voltage(rms)	Range	0-500V
	Resolution	0.1V
	Accuracy	$\pm (0.2\%+0.6V)$
	Temp. coefficient	$\pm (0.04\%$ per degree from 25°C)
Current(rms)	Range	L:120.0mA *
		M:1.200A *
		H:12.00A *
	Resolution	L:0.1mA
		M:1mA
		H:10mA
Accuracy	L: $\pm (0.2\%+0.6mA)$	
	M: $\pm (0.2\%+6mA)$	
	H: $\pm (0.2\%+0.1A)$	
Temp. coefficient	$\pm (0.04\%$ per degree from 25°C)	
Current(peak)	Range	0-36A
	Resolution	0.01A
	Accuracy	$\pm (1\%+0.36A)$
	Temp. coefficient	$\pm (0.05\%$ per degree from 25°C)
Power	Resolution	L:0.01W
		M:0.1W
		H:1W
	Accuracy	L: $\pm (0.2\%+0.2W)$ (47HZ-65HZ)
		M: $\pm (0.2\%+2W)$ (47HZ-65HZ)
H: $\pm (0.2\%+15W)$ (47HZ-65HZ)		
Temp. coefficient	$\pm (0.05\%$ per degree from 25°C)	
GENERAL		

Memory	10 memories
Sync Output Signal	Output Signal 5V,BNC type
Interface	LAN,USB,RS232
Operation Environment	0-40°C/20-80%RH
Dimension	27U
Weight	396Kg

*Description about the switch of current range:

When $I_{peak} > 300\%$ (Full rms), the current switch from low range to high range (L to M, M to H).

When $I_{peak} < 20\%$ (Full rms), the current switch from high range to low range (M to L).

When $I_{peak} < 80\%$ (**3Arms**), the current switch from high range to Middle range (H to M).

The above specifications may be subject to change without prior notice.



4.2 Supplemental Characteristics

- State storage capacity
10sets
- Recommended calibration frequency
once a year
- Cooling style
fans

Chapter5 Remote Control



IT7300 series AC source has standard communication interfaces: LAN RS232, USB. You can choose any one of them to communicate with PC.

5.1 RS232 Interface



There is a DB9 connector at the rear of the power supply, when connect to computer, you need to select a cable with COM port on both side; To active you need to press  (Shift)+  (Menu) button to enable the settings in menu to be the same with the PC communication configuration. You could do the secondary development with all SCPI commands.





Note

The RS232 settings must match the settings in front panel system information. If any change, please press  (Shift) +  (Menu) key to modify the menu: SYST SET\COMM.

RS232 data format

RS232 data is a 10-bit word with one start bit and one stop bit. The number of start bit is not programmable. Stop bit is selectable between 1&2. Besides, you can set the parity bit in the menu using the front panel  (Shift) +  key. Parity options are stored in a non-volatile memory.

Baudrate

The front panel  (Shift) +  (Menu) button allows the user to set baud rate which is stored in the non-volatile memory: 4800,9600,19200 38400, 57600,115200

RS-232 connection

Adopt the RS232 cable with DB-9 interface because the serial port of RS232 can be connected with that of the controller (e.g. PC). The modulating cable of the air-conditioner is not recommended. The pins of plug are shown as the following table.

If your computer is provided with a RS232 interface with DB-25 plug, a cable and an adapter with DB-25 plug (one end) and DB-9 plug (the other end) are required (not the modulating cable of the air-conditioner)



Pin number	Description
1	No connection
2	TXD, transfer data
3	RXD, receive data
4	No connection
5	GND, ground
6	No connection
7	CTS, clear transfer
8	RTS, ready to transfer
9	No connection

RS-232 Troubleshooting

In case of connection failure of RS232, perform following check:

- Check if the computer and power supply are provided with same Baud rate, parity check bit, data bit and flow control. The power supply shall be configured with one start bit (fixed) and one or two stop bits.
- Just as described in the RS232 connector, appropriate interface cable or adapter shall be adopted. Notes: even if the cable is equipped with right plug, internal wiring may be incorrect.
- The interface cable must be connected to the right serial port (COM1 and COM2) of the computer.

Communication Setup

Please ensure the PC and power supply has the same configuration in the following items.

Baudrate: 9600(4800, 9600, 19200, 38400, 57600, 115200). You could enter the system menu to set the baudrate.

Data bit: 8

Stop bit: 1

Parity bit: (none, even, odd)

EVEN **8 data bits have even parity**

ODD **8 data bits have odd parity**

NONE **8 data bits have no parity**

Native machine address: (0 ~31, factory default is 0)

Start Bit	8 Data Bits	Parity=None	Stop Bit
-----------	-------------	-------------	----------

5.2 USB Interface

Use a cable with two USB ports to connect power supply and PC. You can program through USB interface to achieve all functions of power supply.



The functions of USB488 interface are as follows:

- Interface is 488.2 USB488 interface
- Receive the following request: REN_CONTROL, GO_TO_LOCAL, and LOCAL_LOCKOUT
- When the interface receives MsgID = TRIGGER USBTMC command, it will transmit the TRIGGER command to the function layer.



The functions of power supply's USB488 are as follows:

- receive all SCPI commands
- device is SR1 enabled
- device is RL1 enabled
- device is DT1 enabled

5.3 LAN Interface

Press  (Shift) +  (Menu) on the front panel together to access the menu. Select LAN in the Communication from System and then configure Gateway, IP, Mask and SocketPort in the LAN option. Connect the LAN interface of power supply to the computer with a reticle (crossed).

5.4 GPIB Interface (IT7300(G) series only)

Use a IEEE488 bus to connect GPIB interfaces of power supply and PC. Please ensure that the screws have been screwed down in order to have a full connection. Then press  +  (Menu) to enter the system menu, and then select the Communication to set the GPIB address. The address range of power supply is 0 to 30. After you set the address, please press  button to confirm, GPIB address is saved in nonvolatile memory.

Appendix

Specifications of Red and Black Test Lines

ITECH provides you with optional red and black test lines, the user can choose the company's test line for testing. For specifications of ITECH test lines and maximum current values, refer to the table below.

Model	Specification	Cross section	Length
IT-E301/10A	10A	-	1m
IT-E301/30A	30A	6mm ²	1.2m
IT-E301/30A	30A	6mm ²	2m
IT-E301/60A	60A	20mm ²	1.5m
IT-E301/120A	120A	50mm ²	2m
IT-E301/240A	240A	70mm ²	1m
IT-E301/240A	240A	70mm ²	2m
IT-E301/360A	360A	95mm ²	2m

For maximum current of AWG copper wire, refer to table blow.

AWG	10	12	14	16	18	20	22	24	26	28
The Maximum current value(A)	40	25	20	13	10	7	5	3.5	2.5	1.7

Note: AWG (American Wire Gage), it means X wire (marked on the wire). The table above lists current capacity of single wire at working temperature of 30°C. For reference only.

Contact US

Thank you for purchasing ITECH products. If you have any doubt about this product, please contact us as follow.

1. Visit ITECH website www.itechate.com .
2. Select the most convenient contact for further consultation.