

Bi-directional Programmable DC Power Supply

IT6000C Series User Manual



Model: IT6000C Series
Version: V2.6/10,2023

Notices

© Itech Electronic, Co., Ltd. 2023

No part of this manual may be reproduced in any form or by any means (including electronic storage and retrieval or translation into a foreign language) without prior permission and written consent from Itech Electronic, Co., Ltd. as governed by international copyright laws.

Manual Part Number



402225

Trademarks

Pentium is U.S. registered trademarks of Intel Corporation.

Microsoft, Visual Studio, Windows and MS Windows are registered trademarks of Microsoft Corporation in the United States and/or other countries and regions.

Warranty

The materials contained in this document are provided “as is”, and is subject to change, without prior notice, in future editions. Further, to the maximum extent permitted by applicable laws, ITECH disclaims all warranties, either express or implied, with regard to this manual and any information contained herein, including but not limited to the implied warranties of merchantability and fitness for a particular purpose. ITECH shall not be held liable for errors or for incidental or indirect damages in connection with the furnishing, use or application of this document or of any information contained herein. Should ITECH and the user enter into a separate written agreement with warranty terms covering the materials in this document that conflict with these terms, the warranty terms in the separate agreement shall prevail.

Technology Licenses

The hardware and/or software described herein are furnished under a license and may be used or copied only in accordance with the terms of such license.

Restricted Rights Legend

Restricted permissions of the U.S. government. Permissions for software and technical data which are authorized to the U.S. Government only include those for custom provision to end users. ITECH follows FAR 12.211 (technical data), 12.212 (computer software). DFARS 252.227-7015 (technical data—commercial products) and DFARS 227.7202-3 (permissions for commercial computer software or computer software documents) while providing the customized business licenses of software and technical data.

Safety Notices

CAUTION

A CAUTION sign denotes a hazard. It calls attention to an operating procedure or practice that, if not correctly performed or adhered to, could result in damage to the product or loss of important data. Do not proceed beyond a CAUTION sign until the indicated conditions are fully understood and met.

WARNING

A WARNING sign denotes a hazard. It calls attention to an operating procedure or practice that, if not correctly performed or adhered to, could result in personal injury or death. Do not proceed beyond a WARNING sign until the indicated conditions are fully understood and met.



Note

A NOTE sign denotes important hint. It calls attention to tips or supplementary information that is essential for users to refer to.

Quality Certification and Assurance

We certify that series instrument meets all the published specifications at time of shipment from the factory.

Warranty

ITECH warrants that the product will be free from defects in material and workmanship under normal use for a period of one (1) year from the date of delivery (except those described in the Limitation of Warranty below).



Note

Visit <https://www.itechate.com/en/support/register.html> to complete product registration by filling out the necessary information to extend the warranty to two (2) years.

For warranty service or repair, the product must be returned to a service center designated by ITECH.















- The product returned to ITECH for warranty service must be shipped PRE-PAID. And ITECH will pay for return of the product to customer.
- If the product is returned to ITECH for warranty service from overseas, all the freights, duties and other taxes shall be on the account of customer.

Limitation of Warranty

This Warranty will be rendered invalid in case of the following:

- Damage caused by circuit installed by customer or using customer own products or accessories;
- Modified or repaired by customer without authorization;
- Damage caused by circuit installed by customer or not operating our products under designated environment;
- The product model or serial number is altered, deleted, removed or made illegible by customer;
- Damaged as a result of accidents, including but not limited to lightning, moisture, fire, improper use or negligence.

Safety Symbols

	Direct current		ON (power)
	Alternating current		OFF (power)
	Both direct and alternating current		Power-on state
	Chassis (earth ground) symbol.		Power-off state
	Earth (ground) terminal		Reference terminal
	Caution		Positive terminal
	Warning (refer to this manual for specific Warning or Caution information)		Negative terminal
	A chassis terminal	-	-

Safety Precautions

The following safety precautions must be observed during all phases of operation of this instrument. Failure to comply with these precautions or specific warnings elsewhere in this manual will constitute a default under safety standards of design, manufacture and intended use of the instrument. ITECH assumes no liability for the customer's failure to comply with these precautions.

WARNING

- **Do not use the instrument if it is damaged. Before operation, check the casing to see whether it cracks. Do not operate the instrument in the presence of inflammable gasses, vapors or dusts.**
 - **The instrument is provided with a power cord during delivery and should be connected to a socket with a protective earth terminal, a junction box or a three-phase distribution box. Before operation, be sure that the instrument is well grounded.**
 - **Please always use the provided cable to connect the instrument.**
 - **Check all marks on the instrument before connecting the instrument to power supply.**
 - **Ensure the voltage fluctuation of mains supply is less than 10% of the working voltage range in order to reduce risks of fire and electric shock.**
 - **Do not install alternative parts on the instrument or perform any unauthorized modification.**
 - **Do not use the instrument if the detachable cover is removed or loosen.**
 - **To prevent the possibility of accidental injuries, be sure to use the power adapter supplied by the manufacturer only.**
 - **We do not accept responsibility for any direct or indirect financial damage or loss of profit that might occur when using the instrument.**
 - **This instrument is used for industrial purposes, do not apply this product to IT power supply system.**
 - **Never use the instrument with a life-support system or any other equipment subject to safety requirements.**
-

WARNING

- **SHOCK HAZARD Ground the Instrument.** This product is provided with a protective earth terminal. To minimize shock hazard, the instrument must be connected to the AC mains through a grounded power cable, with the ground wire firmly connected to an electrical ground (safety ground) at the power outlet or distribution box. Any interruption of the protective (grounding) conductor or disconnection of the protective earth terminal will cause a potential shock hazard that could result in injury or death.
 - **Before applying power, verify that all safety precautions are taken.** All connections must be made with the instrument turned off, and must be performed by qualified personnel who are aware of the hazards involved. Improper actions can cause fatal injury as well as equipment damage.
 - **SHOCK HAZARD, LETHAL VOLTAGES** This product can output the dangerous voltage that can cause personal injury, and the operator must always be protected from electric shock. Ensure that the output electrodes are either insulated or covered using the safety covers provided, so that no accidental contact with lethal voltages can occur.
 - **Never touch cables or connections immediately after turning off the instrument.** Verify that there is no dangerous voltage on the electrodes or sense terminals before touching them.
 - **After using the device, turn off the power switch of the device before unplugging the power cord or disassembling the terminals.** Do not touch the cable or the terminal immediately. Depending on the model, the dangerous voltage at the plug or terminal is maintained for 10 seconds after the device is switched off. Make sure that there is no dangerous voltage before touching them.
-

CAUTION

- **Failure to use the instrument as directed by the manufacturer may render its protective features void.**
 - **Always clean the casing with a dry cloth. Do not clean the internals.**
 - **Make sure the vent hole is always unblocked.**
-

Environmental Conditions





The instrument is designed for indoor use and an area with low condensation. The table below shows the general environmental requirements for the instrument.

Environmental Conditions	Requirements
Operating temperature	0°C ~ 50°C
Operating humidity	20% ~ 80%(non-condensation)
Storage temperature	-10°C ~ 70 °C
Altitude	Operating up to 2,000 meters
Installation category	II
Pollution degree	Pollution degree 2



Note

In order to ensure the accuracy of measurement, it is recommended to operate the instrument half an hour after start-up.

Regulation Tag

	The CE tag shows that the product complies with the provisions of all relevant European laws (if the year is shown, it indicates that the year when the design is approved).
	The UKCA tag shows that the product complies with the provisions of all relevant United Kingdom laws (if the year is shown, it indicates that the year when the design is approved).
	This instrument complies with the WEEE directive (2002/96/EC) tag requirements. This attached product tag shows that the electrical/electronic product cannot be discarded in household waste.
	This symbol indicates that no danger will happen or toxic substances will not leak or cause damage in normal use within the specified period. The service life of the product is 10 years. The product can be used safely within the environmental protection period; otherwise, the product should be put into the recycling system.

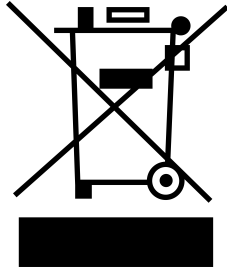
Waste Electrical and Electronic Equipment (WEEE) Directive



Waste electrical and electronic equipment (WEEE) directive, 2002/96/EC

The product complies with tag requirements of the WEEE directive (2002/96/EC). This tag indicates that the electronic equipment cannot be disposed of as ordinary household waste. Product Category

According to the equipment classification in Annex I of the WEEE directive, this instrument belongs to the "Monitoring" product.

If you want to return the unnecessary instrument, please contact the nearest sales office of ITECH.

Compliance Information

Complies with the essential requirements of the following applicable European Directives, and carries the CE marking accordingly:

- Electromagnetic Compatibility (EMC) Directive 2014/30/EU
- Low-Voltage Directive (Safety) 2014/35/EU

Conforms with the following product standards:

EMC Standard

IEC 61326-1:2012/ EN 61326-1:2013 ¹²³

Reference Standards

CISPR 11:2015+A1:2016 Ed 6.1

IEC 61000-3-2: 2018 RLV

IEC 61000-3-3: 2013+A1:2017

IEC 61000-4-2:2008

IEC 61000-4-3 2006+A1:2007+A2:2010/ EN 61000-4-3 A1:2008+A2:2010

IEC 61000-4-4:2012

IEC 61000-4-5:2014+A1:2017

IEC 61000-4-6:2013+cor1:2015

IEC 61000-4-11:2004+A1:2017

1. The product is intended for use in non-residential/non-domestic environments. Use of the product in residential/domestic environments may cause electromagnetic interference.
2. Connection of the instrument to a test object may produce radiations beyond the specified limit.
3. Use high-performance shielded interface cable to ensure conformity with the EMC standards listed above.

Safety Standard

IEC 61010-1:2010+A1:2016

Content

Quality Certification and Assurance	I
Warranty	I
Limitation of Warranty	I
Safety Symbols	II
Safety Precautions	II
Environmental Conditions	IV
Regulation Tag	V
Waste Electrical and Electronic Equipment (WEEE) Directive	VI
Compliance Information	VII
1 Quick Reference	1
1.1 Brief Introduction	1
1.2 Front-Panel Overview	5
1.3 Keyboard Introduction	5
1.4 Push-on Knob	8
1.5 Rear Panel Introduction	9
1.6 VFD Indicator Lamps Description	11
1.7 Configuration Menu Function	12
1.8 System Menu Function	13
1.9 Options Introduction	18
2 Inspection and Installation	21
2.1 Unpacking and Transportation	21
2.2 Verifying the Shipment	24
2.3 Instrument Size Introduction	25
2.4 Connecting the Power Cord	29
2.5 Connecting the Device Under Test (DUT)	35
2.6 Remote Interface Connection	41
2.6.1 USB Interface	41
2.6.2 LAN Interface	42
2.6.3 CAN Interface	47
2.6.4 GPIB Interface (Optional)	48
2.6.5 RS-232 Interface (Optional)	49
3 Getting Started	52
3.1 Power-on Self-Test	52
3.2 Set Output Value	56
3.3 Use the Front Panel Menu	57
3.4 On/Off Control	58
4 Power Supply Function	60
4.1 Set the Output Voltage	60
4.2 Set the Output Current	60
4.3 Set the Output Power	61
4.4 Config Menu for Power Supply	61
4.4.1 Set the CC/CV Priority Mode	61
4.4.2 Set the Internal Resistance	65
4.4.3 CR Function in Sink Mode	66
4.4.4 Set the Output-On/Output-Off Delay	67
4.5 Protection Function for Power Supply	67
4.5.1 Set Over-Voltage Protection (OVP)	70
4.5.2 Set Over-Current Protection (OCP)	71
4.5.3 Set Over-Power Protection (OPP)	72
4.5.4 Set Under-Current Protection (UCP)	73
4.5.5 Set Under-Voltage Protection (UVP)	74
4.5.6 Over-Temperature Protection (OTP)	74
4.5.7 Sense Reverse Protection	75
4.6 Function Menu for Power Supply	76
4.6.1 LIST Function	76

4.6.2	Battery Charging/Discharging Test Function.....	87
4.6.3	Built-in Waveform Function	90
4.6.4	Solar Photovoltaic Curve Simulation Function (SAS)	148
4.6.5	Battery Simulation Function	153
5	Basic Operation.....	158
5.1	Local/Remote Mode Switch	158
5.2	Key Lock Function	158
5.3	Save and Recall Operations	159
5.3.1	Save Operation.....	160
5.3.2	Recall Operation.....	160
5.4	Data Logging Function.....	160
5.5	Set the Beeper Status (Beep).....	163
5.6	Set the Power-on State (PowerOn)	164
5.7	Sense Function (Sense)	165
5.8	Select Trigger Source (Trig Source)	166
5.9	Set the Communication Information (I/O Con)	167
5.10	Set Parallel Operation Mode (Parallel)	168
5.11	Digital I/O Function (Digital Port).....	172
5.11.1	IO-1. Ps-Clear, Not-Invert	176
5.11.2	IO-2. Ps, Not-Invert	178
5.11.3	IO-3. Off-Status, Not-Invert.....	179
5.11.4	IO-4. Ext-Trig, Not-Invert.....	181
5.11.5	IO-5. INH-Living, Not-Invert	184
5.11.6	IO-6. Sync-On, Not-Invert	188
5.11.7	IO-7. Sync-Off, Not-Invert.....	190
5.12	Analogue Function (Ext-Program) (Optional).....	192
5.13	Restored to Factory Setting (System Reset).....	197
5.14	View the System Information (System Info)	199
5.15	System Upgrade	200
6	Technical Specification.....	204
6.1	Main Specification.....	204
6.1.1	80V.....	205
6.1.1.1	IT6005C-80-150	205
6.1.1.2	IT6010C-80-300	207
6.1.1.3	IT6015C-80-450	209
6.1.1.4	IT6030C-80-900	211
6.1.1.5	IT6045C-80-1350	214
6.1.1.6	IT6060C-80-1800	216
6.1.1.7	IT6075C-80-2040	218
6.1.1.8	IT6090C-80-2040	220
6.1.1.9	IT6105C-80-2040	223
6.1.1.10	IT6120C-80-2040	225
6.1.2	300V.....	227
6.1.2.1	IT6006C-300-75	227
6.1.2.2	IT6012C-300-150	229
6.1.2.3	IT6018C-300-225	232
6.1.2.4	IT6036C-300-450	234
6.1.2.5	IT6054C-300-675	236
6.1.2.6	IT6072C-300-900	238
6.1.2.7	IT6090C-300-1125	240
6.1.2.8	IT6108C-300-1350	243
6.1.2.9	IT6126C-300-1575	245
6.1.2.10	IT6144C-300-1800	247
6.1.3	500V.....	249
6.1.3.1	IT6006C-500-40	249
6.1.3.2	IT6012C-500-80	252
6.1.3.3	IT6018C-500-120	254
6.1.3.4	IT6036C-500-240	256

6.1.3.5	IT6054C-500-360	258
6.1.3.6	IT6072C-500-480	260
6.1.3.7	IT6090C-500-600	263
6.1.3.8	IT6108C-500-720	265
6.1.3.9	IT6126C-500-840	267
6.1.3.10	IT6144C-500-960	269
6.1.4	800V	272
6.1.4.1	IT6006C-800-25	272
6.1.4.2	IT6012C-800-50	274
6.1.4.3	IT6018C-800-75	276
6.1.4.4	IT6036C-800-150	278
6.1.4.5	IT6054C-800-225	280
6.1.4.6	IT6072C-800-300	282
6.1.4.7	IT6090C-800-375	285
6.1.4.8	IT6108C-800-450	287
6.1.4.9	IT6126C-800-525	289
6.1.4.10	IT6144C-800-600	291
6.1.5	1500V	293
6.1.5.1	IT6018C-1500-40	293
6.1.5.2	IT6036C-1500-80	296
6.1.5.3	IT6054C-1500-120	298
6.1.5.4	IT6072C-1500-160	300
6.1.5.5	IT6090C-1500-200	302
6.1.5.6	IT6108C-1500-240	304
6.1.5.7	IT6126C-1500-280	307
6.1.5.8	IT6144C-1500-320	309
6.1.6	2250V	311
6.1.6.1	IT6018C-2250-25	311
6.1.6.2	IT6036C-2250-50	313
6.1.6.3	IT6054B-2250-75	315
6.1.6.4	IT6072C-2250-100	318
6.1.6.5	IT6090C-2250-125	320
6.1.6.6	IT6108C-2250-150	322
6.1.6.7	IT6126C-2250-175	324
6.1.6.8	IT6144C-2250-200	326
6.7	Supplemental Characteristics	329
7	Routine Maintenance	330
7.1	Instrument Self-Test	330
7.2	Cleaning and Maintenance	330
7.3	Contact of ITECH Engineers	331
7.4	Return for Repair	332
A	Appendix	334
A.1	Specifications of Red and Black Test Cables	334
A.2	Troubleshooting	335
A.3	Fuse Replacement	337

1 Quick Reference

This Chapter will introduce power-on check steps of this series to ensure normal start-up and usage under initialization status of the power. Besides, to facilitate usage, this part also displays the functions of front board, rear board and keyboard keys as well as display functions to a quick view of power appearance, structure and key usage functions before operation.

- ◆ [Brief Introduction](#)
- ◆ [Front-Panel Overview](#)
- ◆ [Keyboard Introduction](#)
- ◆ [Push-on Knob](#)
- ◆ [Rear Panel Introduction](#)
- ◆ [VFD Indicator Lamps Description](#)
- ◆ [Configuration Menu Function](#)
- ◆ [System Menu Function](#)
- ◆ [Options Introduction](#)

1.1 Brief Introduction

The IT6000C series Bi-directional Programmable DC Power Supply supports a variety of output capabilities to satisfy different test requirement such as high current and low voltage or high voltage and low current. Meanwhile, units of the same model can be run in parallel to deliver stronger output capacity.

In addition to the above powerful and diverse output capability, based on conventional features (such as List function, comprehensive protection and other functions), the IT6000C series Bi-directional Programmable DC Power Supply also supports a variety of unique features, such as digital I/O, data logging, energy regeneration, and the selective upgrade of system files.

More functions, technical indicators and technical innovations are described below:

- The instrument supports bi-directional energy transmission and feeds electric energy back to the grid in a pollution-free manner, thus cutting electricity and heat dissipation costs and meeting energy-saving and environmental protection demands;
- It supports optional system file upgrade and one-click check of such information as system version and system configuration;
- Support List, battery test, comprehensive protection and parallel function.

- During the test, the instrument can record specific data type (such as voltage value) and save it in the USB memory device;
- The front panel can be inserted with the USB memory device to support such functions as system file upgrade, import/export of List files and data record;
- Strong Digital I/O Function: In addition to general digital signal I/O functions, it can also be customized by supporting the wiring through different pins to meet different special needs through different pin wirings;
- Select CC loop priority or CV loop priority. If voltage and current parameters are to be changed frequently during test, the user can directly set related parameters through **[V-set]** and **[I-set]** on the front panel, which is very convenient;
- Built-in voltage curves comply with multiple automotive standards for quick user recall.
- Built-in maximum power point tracking (MPPT) mechanism to provide solar photovoltaic curve simulation.
- High visible vacuum fluorescent display (VFD)
- Support optical fiber communication, which is applicable for loop control between units under parallel mode.
- Built-in USB/CAN/LAN communication interface
- Optional GPIB/RS-232 communication interface
- Optional external analog interface, and share an interface position with RS-232.
- Strong trigger system;
- Enable a true seamless switch between positive current and negative current while avoiding overshoot current and overshoot voltage;
- When the Sense function is turned on, it can ensure that the DUT is safe in case of reverse connection or open circuit of the Sense line.



Note

The IT6000C series was designed to allow paralleling of multiple units to create larger power systems. Expandable in master and slave parallel Up to 1152kW. All program is performed from the master unit front panel or remote control interfaces. Consolidated current and power measurements are reported on the master unit. The function and operation of the instrument are the same as that of the single instrument. For detailed specifications, please contact ITECH service.

The models included in the IT6000C series are as follows:

Voltage Level	Model	Current	Power
80V	IT6005C-80-150	150A	5KW
	IT6010C-80-300	300A	10KW
	IT6015C-80-450	450A	15KW
	IT6030C-80-900	900A	30kW
	IT6045C-80-1350	1350A	45kW
	IT6060C-80-1800	1800A	60kW
	IT6075C-80-2040	2040A	75kW
	IT6090C-80-2040	2040A	90kW
	IT6105C-80-2040	2040A	105kW
	IT6120C-80-2040	2040A	120kW
300V	IT6006C-300-75	75A	6kW
	IT6012C-300-150	150A	12kW
	IT6018C-300-225	225A	18kW
	IT6036C-300-450	450A	36kW
	IT6054C-300-675	675A	54kW
	IT6072C-300-900	900A	72kW
	IT6090C-300-1125	1125A	90kW
	IT6108C-300-1350	1350A	108kW
	IT6126C-300-1575	1575A	126kW
	IT6144C-300-1800	1800A	144kW
500V	IT6006C-500-40	40A	6KW
	IT6012C-500-80	80A	12KW
	IT6018C-500-120	120A	18KW
	IT6036C-500-240	240A	36kW
	IT6054C-500-360	360A	54kW
	IT6072C-500-480	480A	72kW
	IT6090C-500-600	600A	90kW
	IT6108C-500-720	720A	108kW
	IT6126C-500-840	840A	126kW
	IT6144C-500-960	960A	144kW

Voltage Level	Model	Current	Power
800V	IT6006C-800-25	25A	6KW
	IT6012C-800-50	50A	12KW
	IT6018C-800-75	75A	18KW
	IT6036C-800-150	150A	36kW
	IT6054C-800-225	225A	54kW
	IT6072C-800-300	300A	72kW
	IT6090C-800-375	375A	90kW
	IT6108C-800-450	450A	108kW
	IT6126C-800-525	525A	126kW
	IT6144C-800-600	600A	144kW
1500V	IT6018C-1500-40	40A	18KW
	IT6036C-1500-80	80A	36kW
	IT6054C-1500-120	120A	54kW
	IT6072C-1500-160	160A	72kW
	IT6090C-1500-200	200A	90kW
	IT6108C-1500-240	240A	108kW
	IT6126C-1500-280	280A	126kW
	IT6144C-1500-320	320A	144kW
2250V	IT6018C-2250-25	25A	18KW
	IT6036C-2250-50	50A	36kW
	IT6054C-2250-75	75A	54kW
	IT6072C-2250-100	100A	72kW
	IT6090C-2250-125	125A	90kW
	IT6108C-2250-150	150A	108kW
	IT6126C-2250-175	175A	126kW
	IT6144C-2250-200	200A	144kW



Note

Naming rules for each series of model are as follows: IT 6XXXC-YYY-ZZZ, wherein, XXX means rated power; YYY means rated voltage; and ZZZ means rated current.

As a bidirectional power supply, this series can output and absorb electric energy. The current and power input capacity is same as the output capacity. For example, the maximum rated value of the output power of the IT6018C-500-90 model is 18,000W, and the maximum rated value of input power is also 18,000W.

1.2 Front-Panel Overview

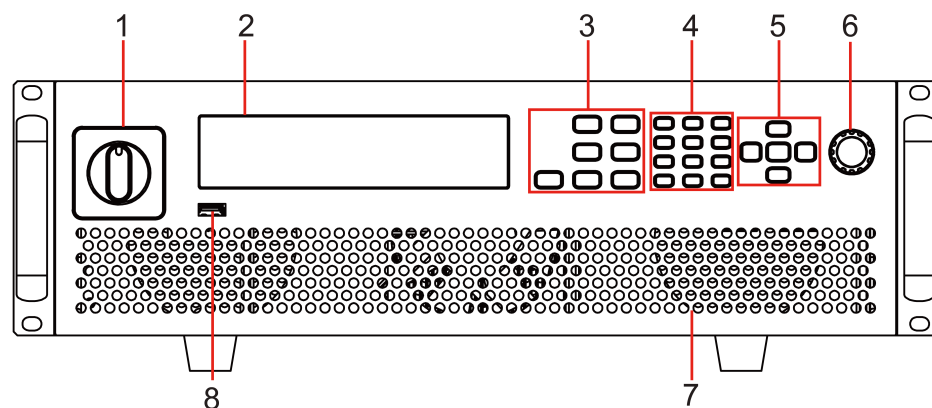
For the IT6000C series Bi-directional Programmable DC Power Supply, all front panels of the 3U model are the same, and the operation panels of other models are the same as those of the 3U model. The following is the front panel schematic of the 3U model.



3U Model

- | | |
|------------------------------------|--|
| 1 Power On/Off switch | 5 Up, down, left, and right cursor navigation keys and Enter key |
| 2 Vacuum fluorescent display (VFD) | 6 Push-on knob |
| 3 Function and composite keys | 7 Vent hole |
| 4 Numeric and composite keys | 8 USB storage device connection port |

1.3 Keyboard Introduction

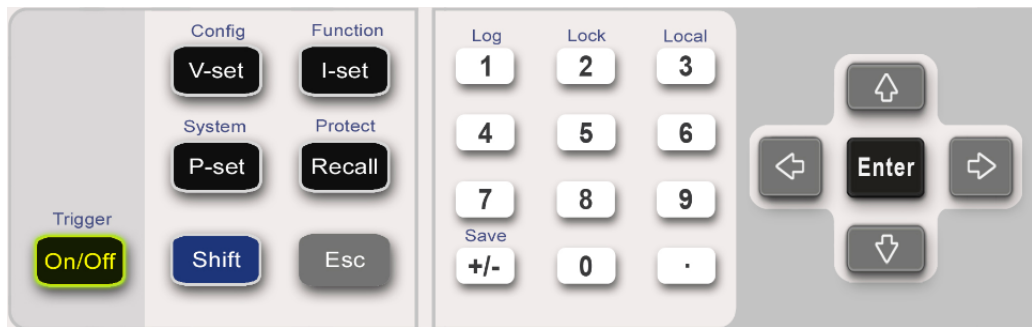
The keyboard introduction of IT6000C series Bi-directional Programmable DC Power Supply is shown as follows.



Keys	Description
[On/Off]	Turn the power supply output on or off. When lit, indicates that the output is enabled or on.
[V-set]	Set the output voltage value <div style="text-align: center;">  Note In CV priority (default) mode, press [V-set], the interface displays “Vs=0.00V” (Setting value of voltage). In CC priority mode, press [V-set], the interface displays “Vh= 0.00V” (Upper limit of voltage), and press [V-set] again, the interface displays “Vl=0.00V” (Lower limit of voltage). </div>
[I-set]	Set the output current value <div style="text-align: center;">  Note In CV priority (default) mode, press [I-set], the interface displays “I+=0.00A” (Upper limit of current) , and press [I-set] again, the interface displays “I- = - 0.00 A” (Lower limit of current). In CC priority mode, press [I-set], the interface displays “Is=0.00A” (Setting value of current). </div>
[P-set]	Set the output power value <div style="text-align: center;">  Note Press [P-set], the interface displays “P+=0.00W” (Upper limit of power) , and press [P-set] again, the interface displays “P- = - 0.00W” (Lower limit of power) . </div>
[Recall]	Returns the instrument to the specified setup.
[Shift]	Composite key, combined with other keys to realize functions marked above keys.
[Esc]	Press this key to exit the current operation interface.

Keys	Description
[0]-[9]	Numeric keys
+/-	Positive and negative signs
.	Decimal point
Left / Right navigation keys	The left and right navigation keys are used to adjust the cursor to the specified position or scrolls pages to view menu items.
Up / Down navigation keys	The up and down navigation keys are used to scroll page up and down to view menu items.
[Enter]	Operation confirmation key

Composite key **[Shift]**, combined with other keys to realize functions marked above keys. The detailed functions are listed as follows.



Note

The **[Shift]+[XXX](YYY)** combination key form identified in this document refers to pressing **[Shift]** button first, then press the **[XXX]** button, please pay attention to the sequence.

Keys	Description
[Shift]+[On/Off] (Trigger)	Generate a local trigger signal.
[Shift]+[V-set] (Config)	Enter to Configuration menu.
[Shift]+[I-set] (Function)	Enter the Function menu.
[Shift]+[P-set] (System)	Enter the System menu.
[Shift]+[Recall] (Protect)	Enter the Protect menu of the power supply
[Shift]+[1] (Log)	Enter the data logging function menu.
[Shift]+[2] (Lock)	Turn the keyboard lock on or off.

Keys	Description
[Shift]+[3] (Local)	Switch remote control mode to local control mode.
[Shift]+[+/-] (Save)	Save the common parameter settings.

1.4 Push-on Knob

The IT6000C series Bi-directional Programmable DC Power Supply provides a knob on the front panel as shown in the next figure.

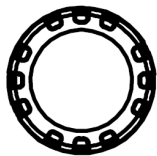

The functions of the push-on knob is described as follows.

- Adjust the value setting
- Select menu item
- Confirm the set value or the selected menu item

Adjust the Value Setting

In the value setting interface, rotate the knob clockwise to increase the set value and anticlockwise to decrease the set value.

Select Menu Item

The knob can also be used to view menu items. In the menu item display interface, turning the knob clockwise indicates that the next menu item is selected, and turning the knob anticlockwise indicates that the previous menu item is selected.

Confirm settings

After completing the value setting or selecting a menu item, pushing the knob acts like pressing **[Enter]** key to confirm the operation.

1.5 Rear Panel Introduction

The rear panel of the 3U model of the IT6000C series Bi-directional Programmable DC Power Supply (after removing the protective cover) is shown below. The rear panel of the 6U model is the same as the 3U model.

3U Models

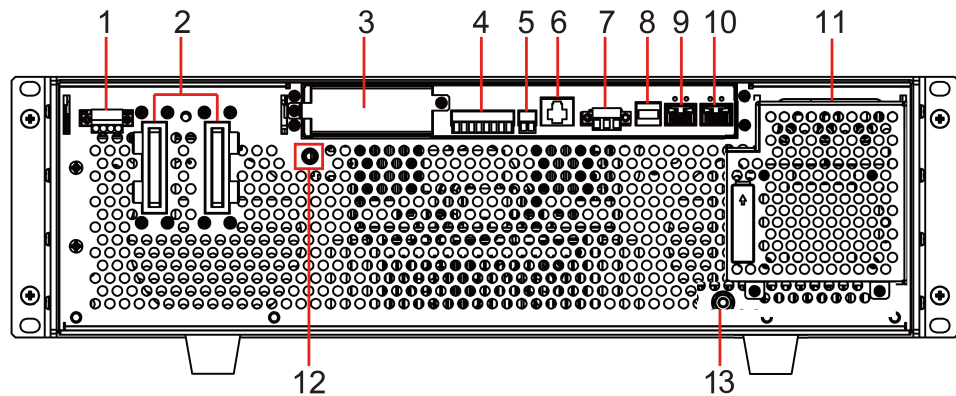

1. Sense terminals (V_{s+} , V_{s-})
2. DC output terminals of the power supply
3. Interface for optional accessories IT-E166 and IT-E167 (For details, see [1.9 Options Introduction](#))
4. Digital I/O interface: P-IO
5. CAN communication interface
6. LAN communication interface
7. External control interface CTRL

Note

This interface is used for the parallel connection between the master (with operation panel) and the slaves (without operation panel). Connect the interface on the rear panel of each unit to be connected in parallel, and the master can offer synchronous control over the power-on/off of the slaves.

8. USB communication interface
9. Communication interface of inner ring optical fiber (F-TX and F-RX)

 **Note**

This interface is used for the parallel connection between the master (with operation panel) and the slaves (without operation panel) for realizing communication of units in parallel.

10. Communication interface of outer ring optical fiber (TX and RX)

 **Note**

This interface is used for the parallel connection between the masters (with operation panel) for the communication of units in parallel.

11. AC power input terminals (L1, L2, L3, and PE)

12. Chassis ground terminal

The 15U and 27U cabinets have the same rear panel terminals except for the cabinet size. The following takes a 15U cabinet as an example.

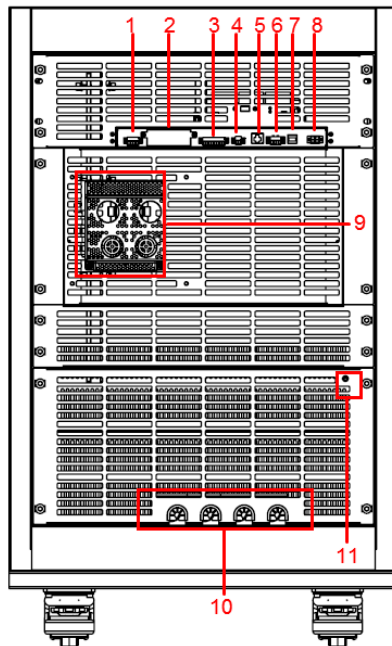

1. Sense terminals (V_{s+} , V_{s-})
2. Interface for optional accessories IT-E166 and IT-E167 (For details, see [1.9 Options Introduction](#))
3. Digital I/O interface: P-IO
4. CAN communication interface
5. LAN communication interface
6. External control interface CTRL
7. USB communication interface
8. Communication interface of outer ring optical fiber (TX and RX)

9. DC output terminals of the power supply
10. AC power input terminals (L1, L2, L3, and PE)
11. Cabinet earthing rod

1.6 VFD Indicator Lamps Description

The IT6000C series Bi-directional Programmable DC Power Supply VFD indicator lamps description is as follows:

Table 1–1 VFD Indicator Lamps Description

Flag	Function Description	Flag	Function Description
OFF	The output of the power supply is turned off.	Sense	Sense function of the power supply is enabled.
CV	The power supply is in a state of constant voltage output.	Rear	Analog function begin to work.
CC	The power supply is in a state of constant current output.	Addr	When received command successfully, the flag will display 3 seconds.
*	The keyboard lock is turned on.	Rmt	Indicates that the instrument is working in remote control mode.
CR	The power supply (Sink) is in constant resistance state.	Error	Error occur
Shift	Using composite function key	Prot	The instrument enters the protection state.
SRQ	Indicates that the internal status request event occurs.	Trig	The instrument is in a state of waiting for a trigger.
CW	The power supply is in a state of constant power output.	-	-

1.7 Configuration Menu Function

This section gives an overview of the configuration menu of the IT6000C series power supply.

The procedures to operate the configuration menu are as follows.

1. Press the composite keys **[Shift]+[V-set]** (Config) on the front panel to enter the configuration menu.

The VFD shows configuration menu items and each menu item is marked with a number. The user can use up and down keys or knob to scroll pages to view the other menu items.

2. Press **[Enter]** to select the desired menu item.

Enter the parameter setting interface of this menu item.

3. After finishing the menu setting, press **[Enter]** key to save the setting.



Note

Press **[Esc]** key to return to the previous menu level.

The descriptions of configuration menu of the power supply are listed in the table below.

Config	Configuration menu of the power supply			
	Mode	CC/CV priority mode setting		
		CV	Constant voltage loop priority mode	
			Speed= High/Low	Loop response speed setting: high speed / low speed
		CC	Constant current loop priority mode	
			Speed= High/Low	Loop response speed setting: high speed / low speed
		V-Rise Time/I-Rise Time = 0.100s		Displays the voltage or current rise time setting according to the selected priority mode. If CC priority mode is selected, the parameter setting of I-Rise Time will be displayed here.

V-Fall Time/I-Fall Time = 0.100s	Displays the voltage or current fall time setting according to the selected priority mode. If CC priority mode is selected, the parameter setting of I-Fall Time will be displayed here.
Output Res	Set the internal resistance of the power supply. This parameter needs to be set only when Mode is set to CV .
Sink Res	Set the CR function in sink mode. This parameter needs to be set only when Mode is selected as CC . <ul style="list-style-type: none"> • OFF: Turn off the CR function. • ON: Turn on the CR function and set Sink Res. Setting range: 0~7500Ω. Set Sink Res=0, which means to turn off the CR function.
On Delay	Set the delay time to turn on the output.
Off Delay	Set the delay time to turn off the output.
Voltage Max	Set the upper limit of the voltage (default is the rated voltage of the instrument). Once the voltage upper limit is modified here, the parameters related to the voltage setting will be limited by the upper limit here.

1.8 System Menu Function

This Chapter offers a general introduction of system menus, allowing users to have a preliminary understanding of system functions of this IT6000C series.

The steps of the system menu function are as follows:

1. Press the composite keys **[Shift]+[P-set]** (System) on the front panel to enter the system menu.

At this point, the VFD screen displays the system menu items. Each menu item has a numbering identifier. The user can press Up and Down buttons or use the knob for scrolling display of other menu items.

2. Press **[Enter]** on a menu interface to enter the setting interface.

- After the menu items are set, press **[Enter]** again to save the modified contents.

Note

You can press **[Esc]** to return to the previous menu.

The description of the menu items is shown in the table below.

Beep	Set the beeper state.	
	On	Turn the beeper on.
	Off	Turn the beeper off.
PowerOn	Set the power-on state.	
	Reset	When the instrument is powered on, the instrument will initialize some settings and [On/Off] state.
	Last	When the instrument is powered on, the instrument will remain the same settings and [On/Off] state as last time you turned off the instrument.
	Last+Off	When the instrument is powered on, the instrument will remain the same settings as last time you turned off the instrument, but the [On/Off] is OFF state.
Sense	Set the sense function state.	
	Off	Turn the sense function off.
	On	Turn the sense function on.
ListTrig Source	Set the trigger method for the List files running.	
	Immediate	Trigger immediately
	Manual	Manual trigger
	Bus	Bus trigger
	External	External trigger
DLogTrig Source	Set the trigger method for the data logging.	
	Immediate	Trigger immediately
	Manual	Manual trigger
	Bus	Bus trigger
	Voltage	Voltage trigger
	Current	Current trigger
	External	External trigger
I/O	Set the communication information between instrument and PC.	
	USB	USB communication interface
	TMC	USB-TMC protocol

		VCP	Virtual serial port				
			Display as the following format: baud rate_data bit_parity bit_stop bit. <ul style="list-style-type: none"> • Select the baud rate from the following options: 4800, 9600, 19200, 38400, 57600, 115200 • Select the data bit from the following options: 5, 6, 7, 8 • Select the parity bit from the following options: N, O, E • Select the stop bit from the following options: 1, 2 				
		LAN	Virtual LAN communication. After selecting this option, you also need to set the communication parameters of the LAN, and the menu items are the same as those in the LAN menu (see below).				
	LAN	LAN communication interface					
		Info	View the LAN information.				
			LAN Status: Down IP Mode: Auto IP: 0.0.0.0 Mask: 0.0.0.0 Gateway: 0.0.0.0 DNS1: 0.0.0.0 DNS2: 0.0.0.0 MAC: 8C:C8:F4:40:01:E1 MDNS Status: HostName: HostDesc: Domain: TCPIP: INSTR Socket Port: 30000				
		IP-Conf	Configure LAN IP information.				
			<table border="1"> <tr> <td>IP-Mode</td> <td>Configure LAN IP mode.</td> </tr> <tr> <td></td> <td> Auto: automatically configure the address of the instrument. Manual: manually configure the address of the instrument. <ul style="list-style-type: none"> • IP: 0.0.0.0 Set the IP address. • Mask: 0.0.0.0 Set the subnet mask. • Gateway: 0.0.0.0 Set the gateway address. </td> </tr> </table>	IP-Mode	Configure LAN IP mode.		Auto: automatically configure the address of the instrument. Manual: manually configure the address of the instrument. <ul style="list-style-type: none"> • IP: 0.0.0.0 Set the IP address. • Mask: 0.0.0.0 Set the subnet mask. • Gateway: 0.0.0.0 Set the gateway address.
IP-Mode	Configure LAN IP mode.						
	Auto: automatically configure the address of the instrument. Manual: manually configure the address of the instrument. <ul style="list-style-type: none"> • IP: 0.0.0.0 Set the IP address. • Mask: 0.0.0.0 Set the subnet mask. • Gateway: 0.0.0.0 Set the gateway address. 						

			<ul style="list-style-type: none"> DNS1: 0.0.0.0 Set the preferred address of the DNS server. If it is not involved, there is no need to set it. DNS2: 0.0.0.0 Set the DNS server alternate address. If it is not involved, there is no need to set it. Socket Port: 30000 Set the port number.
		Serv-Conf	Configure the LAN services.
			<p>MDNS: MDNS service state.</p> <ul style="list-style-type: none"> On Off
			<p>PING: PING service state.</p> <ul style="list-style-type: none"> On Off
			<p>Telnet-scp: telnet-scp service state.</p> <ul style="list-style-type: none"> On Off
			<p>Web: Web service state.</p> <ul style="list-style-type: none"> On Off
			<p>VX-11: VX-11 service state.</p> <ul style="list-style-type: none"> On Off
			<p>Raw-socket: Raw-socket service state.</p> <ul style="list-style-type: none"> On Off
		Restore	<p>Select whether to reset the LAN to the default settings or not.</p> <ul style="list-style-type: none"> NO YES
		Reset	<p>Select whether to confirm the LAN setting or not.</p> <ul style="list-style-type: none"> NO

			<ul style="list-style-type: none"> • YES
	CAN	CAN communication interface.	
	Baudrate	Select the baud rate from the following options: 5k/10k/20k/40k/50k/80k/100k/125k/200k/250k/400k/500k/600k/800k/1000k.	
	Address	Set the instrument address to a number from 0 to 127.	
	Protocol	<ul style="list-style-type: none"> • Canfestival: Use standard can protocol. • BMS: Use the protocol for docking with the BMS system. 	
Display RS232 or GPIB according to optional interface. In addition, RS232 interface and the analog interface share an interface position.	RS232	Select RS-232 communication interface.	
	Baudrate	Baud rate: 4800/9600/19200/38400/57600/115200	
	Databit	Data bit: 5/6/7/8	
	Parity	Parity bit: N (No parity) / E (Even parity) / O (Odd parity)	
	Stopbit	Stop bit: 1/2	
	GPIB	Select GPIB communication interface.	
	Address	Set the communication address (1 to 30).	
Parallel	Set the instruments to parallel operation mode.		
	Single	Set the instrument to single mode, i.e., disable the parallel operation mode.	
	Master	Set the instrument to master mode.	
	Total Unit	Number of parallel instruments.	
	Slave	Set the instrument to slave mode.	
Digital Port	Set Digital I/O By default, the menu item displays 7 options. You can set parameters for each option respectively. After setting, the corresponding change to each option becomes valid immediately. When re-entering DigPort , the interface can display the changed option. For detailed introduction of menus and functions, see 5.11 Digital I/O Function (Digital Port) .		
	IO-1. Ps-Clear, Not-Invert	Function setting of pin 1	
	IO-2. Ps, Not-Invert	Function setting of pin 2	
	IO-3. Off-Status, Not-Invert	Function setting of pin 3	
	IO-4. Ext-Trig, Not-Invert	Function setting of pin 4	
	IO-5. INH-Living, Not-Invert	Function setting of pin 5	

	IO-6. Sync-On, Not-Invert	Function setting of pin 6
	IO-7. Sync-Off, Not-Invert	Function setting of pin 7
Ext-Program	External Analog Function. This function is optional. The menu can only display when corresponding board card is inserted. For details, see 5.12 Analogue Function (Ext-Program) (Optional) .	
System Reset	Select whether to restore the factory default settings or not.	
System Rzero	Used to control whether the voltage is quickly zeroed after the output is turned off. <ul style="list-style-type: none"> • Off: No • On: Yes 	
System Info	View the system information. For details, see 5.14 View the System Information (System Info) .	

1.9 Options Introduction

The IT6000C series Bi-directional Programmable DC Power Supply supports the following types of optional accessories (sold separately), the details are as below:

- **Optional interface card**

- IT-E166: Interface card for GPIB communication. When users need to use GPIB communication, they can choose to purchase this accessory. For details, see [2.6.4 GPIB Interface \(Optional\)](#).
- IT-E167: Interface card that includes RS-232 communication interface, external analog and other functions.

The accessory has a total of 10 pins, and the details of each pin are as follows:

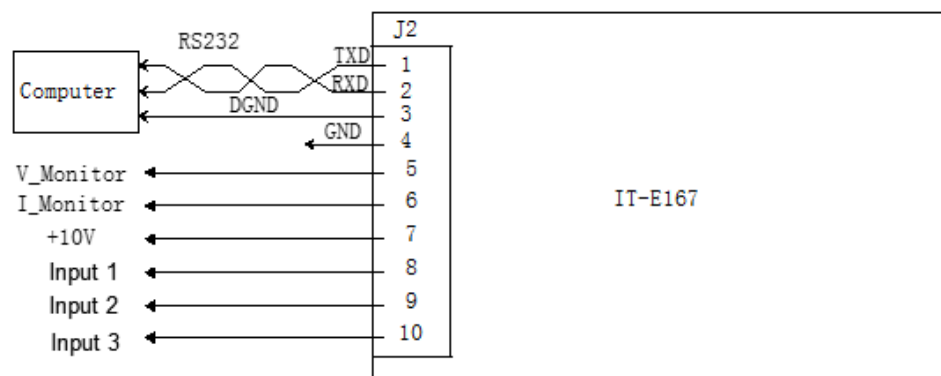

Pins	Description
1	RS-232 TXD pin for transmitting data.
2	RS-232 RXD pin for receiving data.
3	RS-232 DGND pin for grounding.
4	Ground terminal, that is, the negative terminal of pin 5 to pin 10.
5	Voltage monitoring terminal. It can output a voltage of 0 to 10V to monitor the output voltage from 0 to full scale.
6	Current monitoring terminal. It can output a voltage of -10V to 10V to monitor the output current from negative full scale to positive full scale.
7	Reference voltage (10V) test terminal. The accuracy is 0.03%. You can use a multimeter to measure this pin. When the output voltage of the pin is in the range of $10 \pm 0.03\% * 10$, it indicates that the accessory is functioning normally. Otherwise, the function is abnormal and cannot be used.
8 / 9 / 10	Terminals for external analog function. For details, see 5.12 Analogue Function (Ext-Program) (Optional) .

Note

The analog pin has a bandwidth of 10kHz and an input accuracy of $\leq 0.5\%$ FS. The FS refers to -10V to +10V, i. e., FS = 20V.

- **Fiber optic modules and cables**

Fiber optic modules and cables are used for data transmission and communication between parallel units, and are highly resistant to interference. The fiber optic module and cable are the necessary accessories for the parallel connection. Different numbers of fiber optic modules and cables are used in different numbers of parallels.

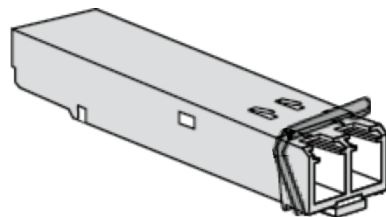

- IT-E168: Used for parallel connection between the units in a cabinet, including one fiber module and two fiber cables, with lengths of 1.5 meters and 0.3 meters.
- IT-E169: Used for parallel connection between cabinets, including one fiber module and one 2.5m fiber cable.
- IT-E165A: Anti-reverse connection module
It is suitable for battery products. This module can be selected to avoid reverse connection during battery wiring.
- IT-E165B: Anti electromotive force module
It is suitable for motor products, which can prevent the electromotive force generated during the operation of the motor from damaging the power supply products.

2 Inspection and Installation

- ◆ Unpacking and Transportation
- ◆ Verifying the Shipment
- ◆ Instrument Size Introduction
- ◆ Connecting the Power Cord
- ◆ Connecting the Device Under Test (DUT)
- ◆ Remote Interface Connection

2.1 Unpacking and Transportation

Unpacking

For cabinet products, they are packaged in wooden boxes at the factory. After you receive them, please refer to the unpacking instructions provided with the box for disassembly; for products packaged in cartons, please use appropriate tools for unpacking.

It is recommended to keep the complete transport packaging for the lifetime of the device for relocation or return to the manufacture for repair.

Transportation

If you need to transport non-cabinet products, you must pay attention to the following to ensure the safety of equipment and personnel.

CAUTION

- **Before moving, make sure that the cabinet or stand where the equipment will be placed has been fixed and meets the load-bearing conditions to avoid tilting and collapsing, causing personnel to be injured, and equipment broken.**
 - **Due to the weight of the product, transport by hand should be avoided where possible. If unavoidable, carry it with two people and holding the product shell and not external parts (such as handles, electrodes, knobs, etc.).**
 - **When carrying, be prepared to bear the weight to avoid sprains or being crushed by heavy objects.**
 - **Use suitable safety clothing, especially safety shoes, when carrying the equipment, as due to its weight a fall can have serious consequences.**
-

After unpacking the cabinet product, if you need to move it to other places, you must pay attention to the following matters to ensure the safety of equipment and personnel.

CAUTION

- The cabinet product is very heavy. Before moving to another location, confirm whether the ground load is in compliance.
- During the process of moving the cabinet, it is recommended that two or more people cooperate and push it slowly and at a constant speed. If you encounter a pit, you need to pay special attention. It is forbidden to push it quickly, otherwise it will easily cause excessive inertia and cause the casters at the bottom of the cabinet to jam and the cabinet to fall.
- It is not advisable to push down the slope to prevent the cabinet from falling down due to the shift of the center of gravity. It is recommended to use a forklift or crane to move the cabinet.
- ITECH 27U and 37U cabinets are equipped with hoisting rings as standard on the top. It is recommended to use a crane equipped with a four-leg hoisting belt structure for horizontal hoisting and moving, and ensure that the four hoisting belts are the same length to avoid cabinet skew during movement. As shown below.
- After moving to the destination, please lock the four casters to secure the cabinet.
- The cabinet should be placed on a level ground. It is forbidden to place the cabinet on a sloped ground.

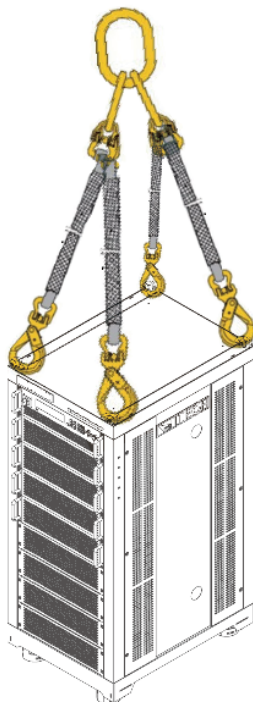

2.2 Verifying the Shipment

Unpack the box and check the contents before operating the instrument. If wrong items have been delivered, if items are missing, or if there is a defect with the appearance of the items, contact the dealer from which you purchased the instrument immediately.

The package contents include:

Item	Qty.	Model	Remarks
Bi-directional Programmable DC Power Supply	x1	IT6000C Series	For the specific models included in this series, refer to 1.1 Brief Introduction .
Power cord	x1	-	Depending on the instrument model. For details, see 2.4 Connecting the Power Cord .
USB communication cable	x1	-	This is used when the USB interface is used for starting up remote operation. Cable length is 1.5 meters.
LAN communication cable	x1	-	This is used when the LAN interface is used for starting up remote operation. Cable length is 2 meters.
Calibration Certificate	x1	-	It is the calibration certificate of the instrument before delivery.



Note

Upon verification of the shipment, keep the package and relevant contents thereof in a safe place. When returning the instrument for warranty service or repair, the specified packing requirements shall be met.

2.3 Instrument Size Introduction

The instrument should be installed at well-ventilated and rational-sized space. Please select appropriate space for installation based on the instrument size.

The detailed dimension drawings of the IT6000C series are as follows (unit: mm, deviation: ± 1 mm):

3U Models

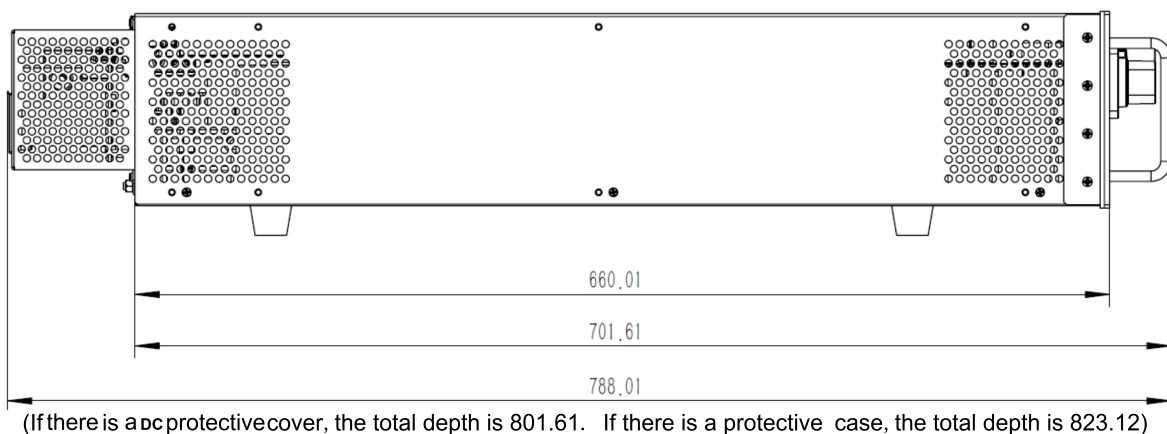
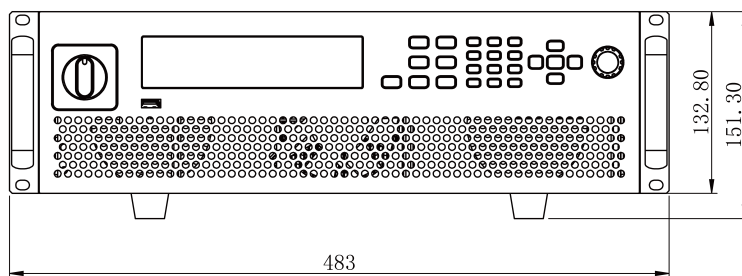

6U Models

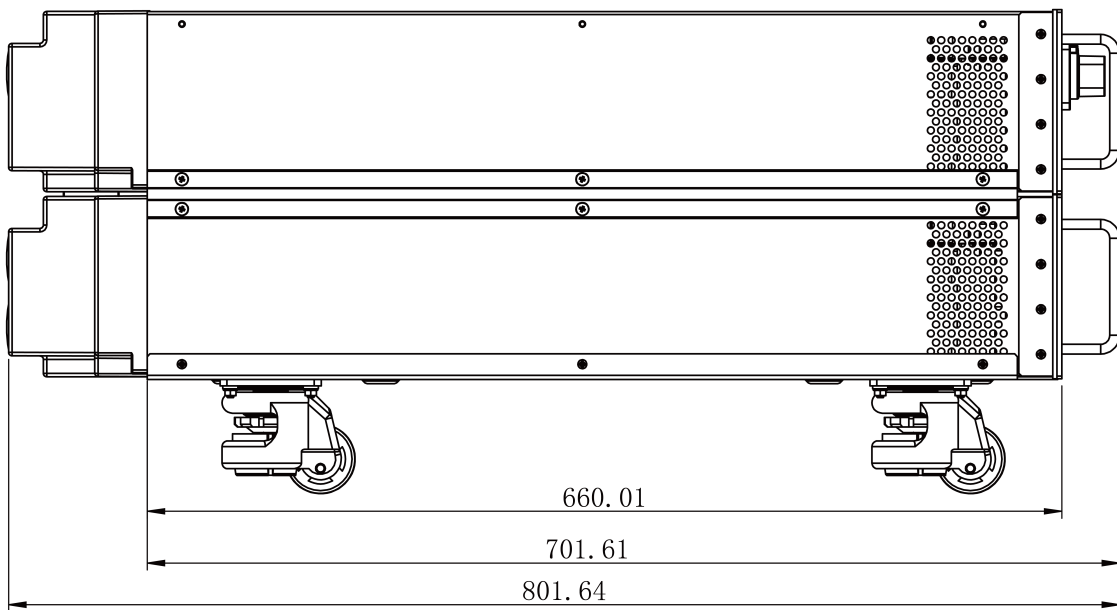
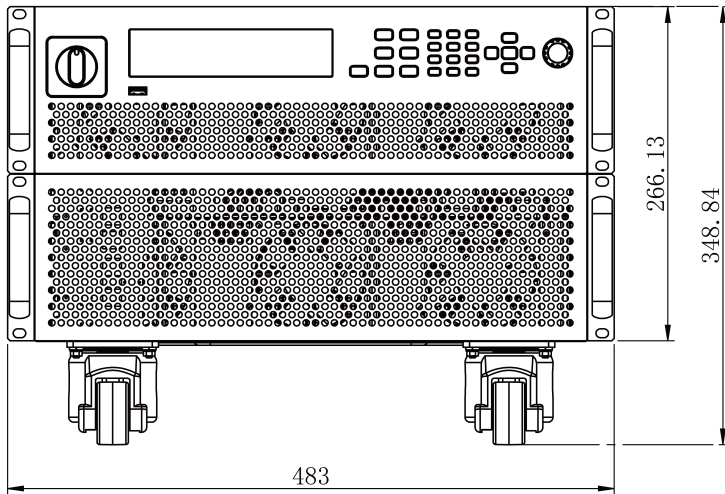

15U Models

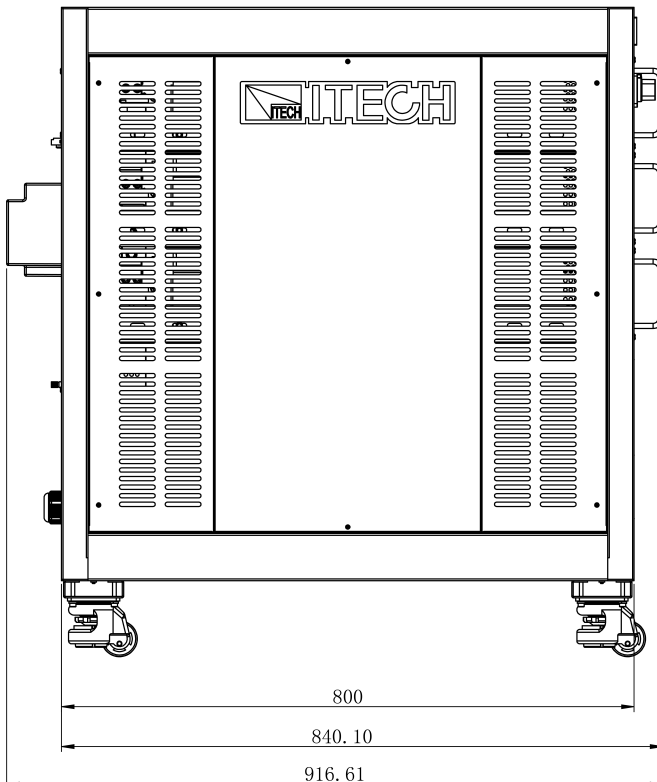
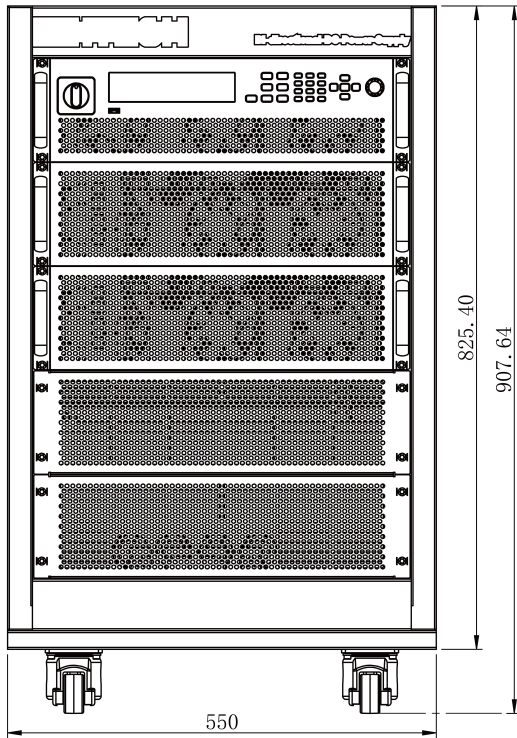

27U Models

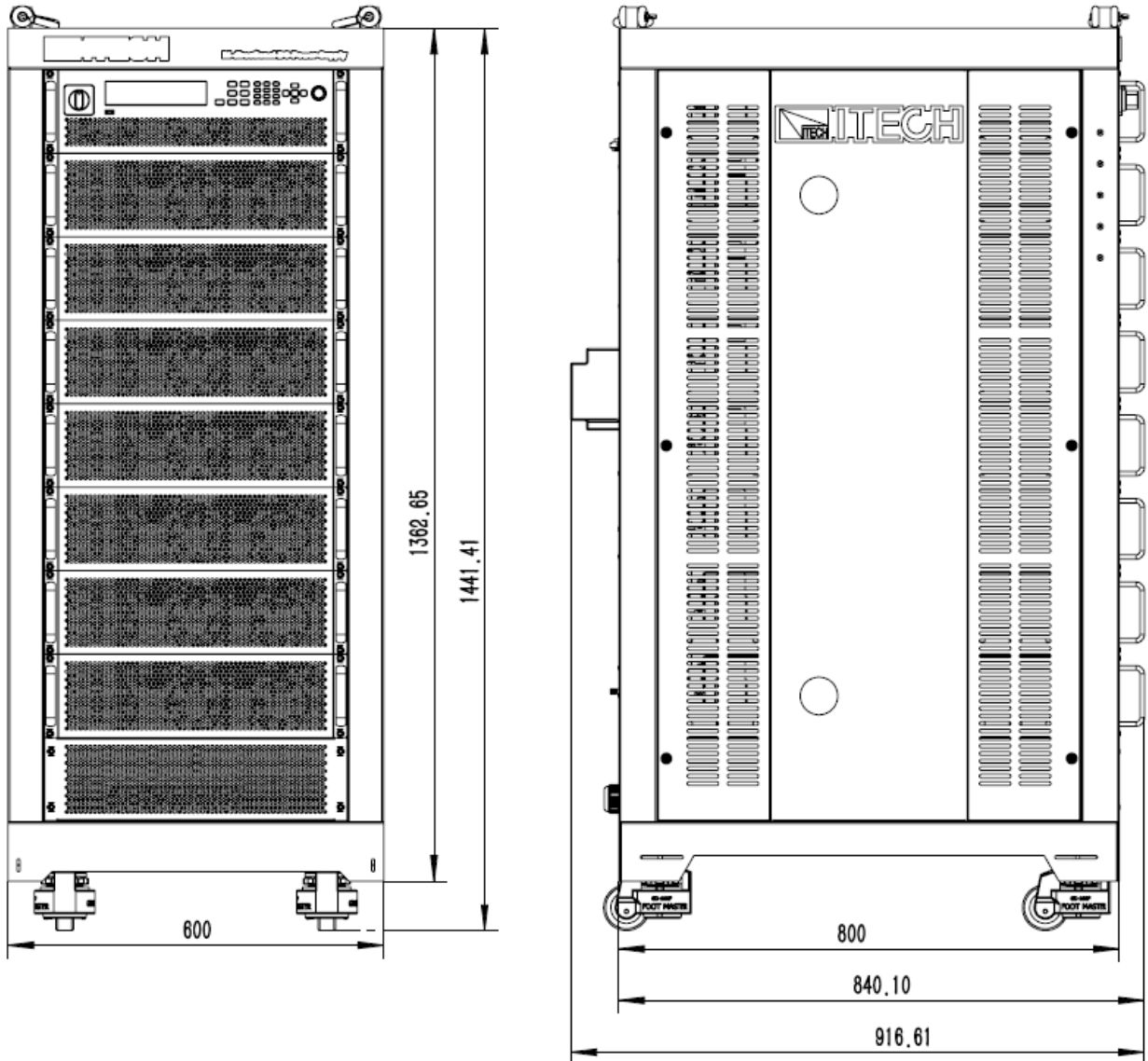

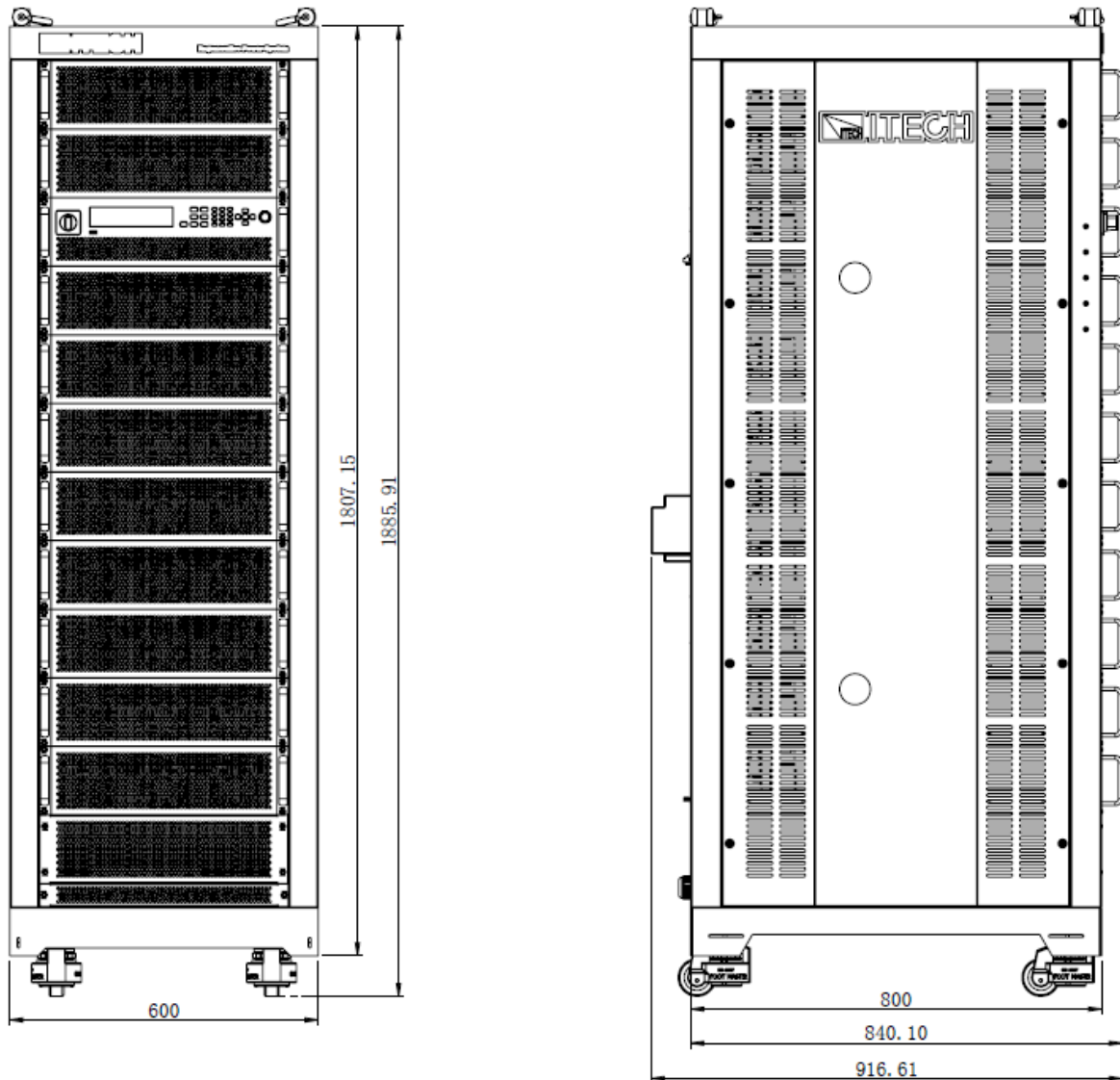
37U Models

Note

The 15U, 27U and 37U cabinets only show the size data. The number of instruments installed in the cabinet should be based on the actual model.

2.4 Connecting the Power Cord

Precautions

To prevent electric shock and damage to the instrument, observe the following precautions.

WARNING

- Before connecting power cord, be sure to confirm that the power voltage matches with the rated input voltage of the instrument.
- Before connecting power cord, be sure to switch off the instrument. Verify that there is no dangerous voltage on the connection terminals.
- To avoid fire or electric shock, make sure to use the power cord supplied by ITECH.
- Be sure to connect the power cord to the AC distribution box with protective grounding. Do not use terminal board without protective grounding.
- Do not use an extended power cord without protective grounding, otherwise the protection function will fail.
- Be sure to perform related operations and connections to feed energy back to grid in accordance with related regulations, and meet all necessary conditions.
- Ensure that the power cord connection terminals are either insulated or covered by the supplied protective cover so that no accidental contact with lethal voltage can occur.

CAUTION

Safety agency requirements dictate that there must be a way to physically disconnect the AC mains cable from the unit. A disconnect device, either a switch or circuit breaker must be provided in the final installation. The disconnect device must be close to the equipment, be easily accessible, and be marked as the disconnect device for this equipment.

Categories of Power Cords

The standard power cord specifications for this series of 3U instruments are divided into the following types according to different regions:

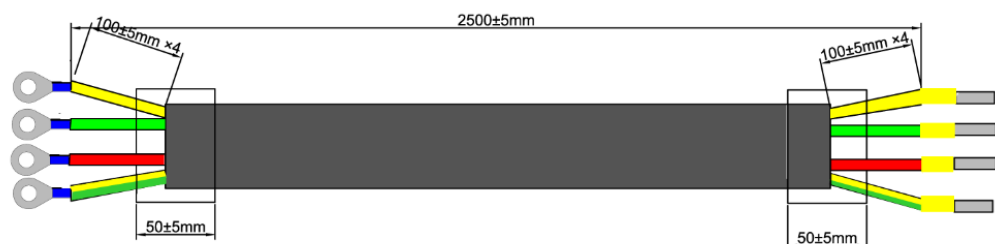

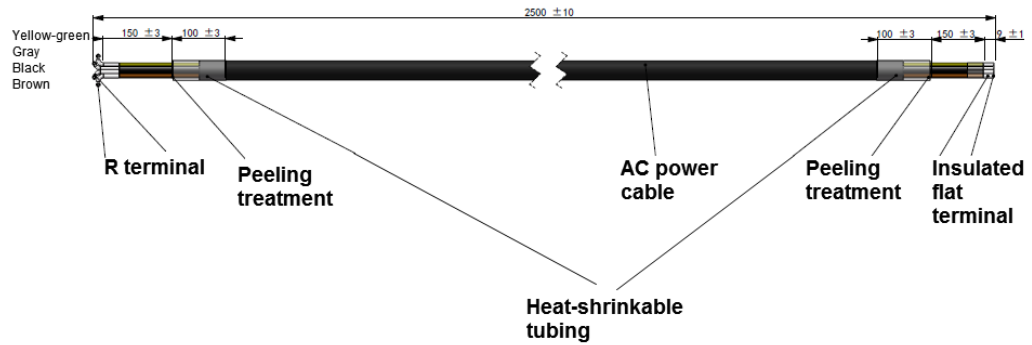

The yellow-green wire is grounding wire, which is connected to the PE terminal of power input on the rear panel; the others are live wires, which are correspondingly connected to the L1, L2 and L3 terminals of power input on the rear panel of the instrument. **L1/L2/L3/PE cable is 6mm².**

AC Power Input Level

The input of this series is a three-phase AC power (three-phase + PE). The voltage level and frequency are as follows. (Note: here is the line voltage, such as L1 and L2)

- Voltage 1: 198V to 264V (Derating 50%), frequency: 47Hz to 63Hz
- Voltage 2: 342V to 528V, frequency: 47Hz to 63Hz

WARNING

- **When the AC input voltage is in the range of Voltage 1, the power setting value is derated by 50%, and when the output exceeds the present rating, the instrument enters AC Input Overcurrent protection and the output is turned off. If a full power output is required, the AC input level Voltage 2 must be selected.**
- **Models without emergency stop module (i.e. AC contactor not included), other AC input voltage ranges are required for customization.**
- **Models without emergency stop module and assembled to the cabinet, with AC input voltage in the range of 198~264V, need to be customized while derating by 50%.**
- **Models with emergency stop module (including AC contactor) only support 380VAC±10% for standard AC input voltage, 480VAC±10% voltage is required for customization.**

The instrument which rated power less than 15kW consumes different current on the three phases. Take the 5kW instrument for example, the rated AC current

of each phase for the single unit is L1/L2:17A, L3:0A, and different model of rated AC current is different, the detailed specification refer to the technical specification.

Connecting the Power Cord

Suggestions for phase assignment:

- When connecting the instrument which rated power less than 10kW to AC distribution box, please take care for balanced current distribution on three phases. For single unit, it requires two or three phases of a three-phase AC distribution box (the rated AC current on L3 is 0, so, it can be connected or not). In case multiple units are connected to the same main AC distribution box. It is recommended to follow the suggestion connection diagram as below.

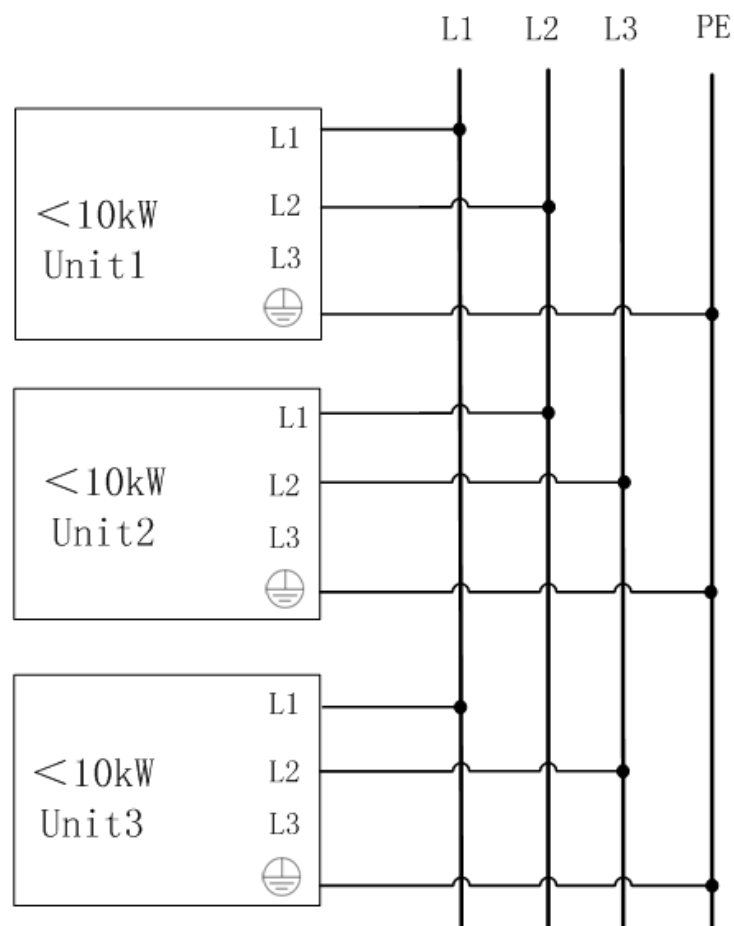

- When connecting the instrument which rated power with $10\text{kW} \leq \text{Power} < 15\text{kW}$ to AC distribution box, For single unit, it requires three phases of a three-phase AC distribution box. In case multiple units are connected to the same main AC distribution box. It is recommended to follow the suggestion connection diagram as below.

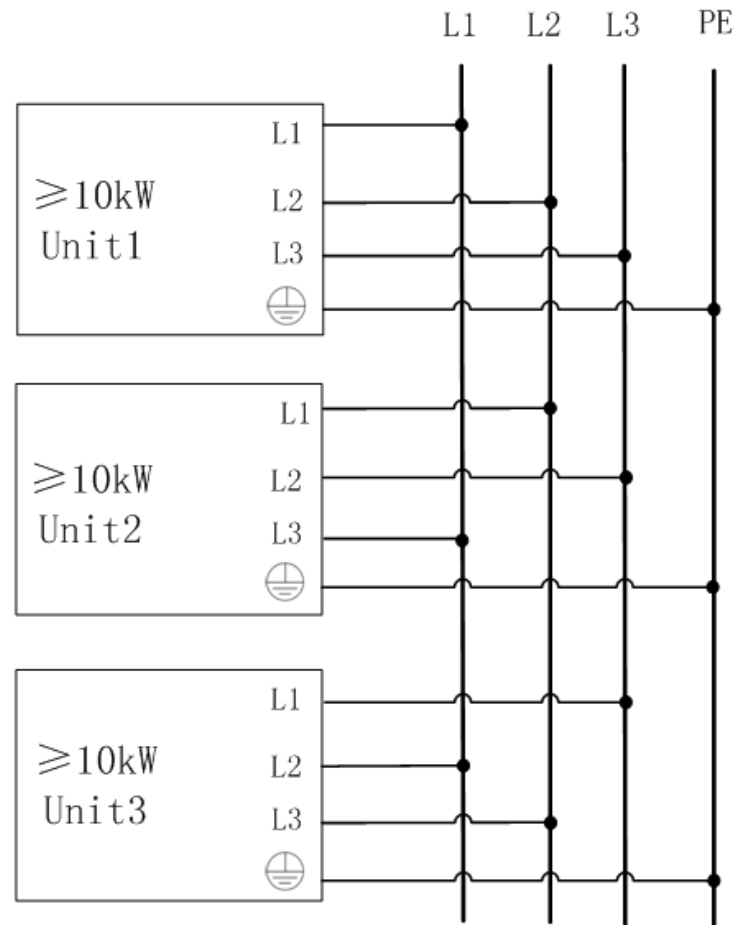

- The instrument which rated power great than or equal to 15kW, they already consume balanced current on all three phases. connecting the power cord as below.

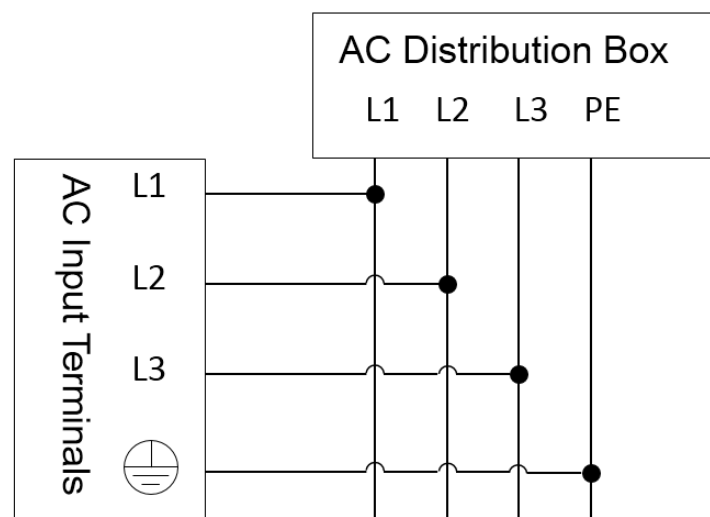

Operation procedures:

- For 3U model (rated power less than or equal to 18kW), see the steps below to connect the power cable.

1. Confirm that the switch of the AC power distribution box is off.
 2. Confirm that the power switch is in the OFF position and verify that there is no dangerous voltage on the connection terminals.
 3. Remove the protective cover outside the AC input terminal on the rear panel.
 4. Connect one end of the power cable's round terminal to the AC power input terminal on the instrument's rear panel.
 - a. You only need to connect the red/green/yellow (or brown/black/gray) live wires to the terminals on the rear panel, which are not required to correspond to L1, L2 and L3 terminals one by one.
 - b. The yellow-green wire is grounding wire, which is connected to the protective grounding terminal (PE).
 5. Mount the protective cover back to its original position.
 6. Refer to the suggestion connection diagram, connect the other end of the power cable to the required AC distribution box.
- The 6U model comes standard with two 3U model power cords, which need to be connected to the AC distribution box respectively, and the AC input terminals of both need to be connected;
 - For models that have been assembled into a cabinet at the factory, users need to connect one end of the power cord to the cabinet and the other end to the distribution box. Refer to the following steps to connect the power cord;
 1. Confirm that the switch of the AC power distribution box is off.
 2. Confirm that the power switch is in the OFF position and verify that there is no dangerous voltage on the connection terminals.
 3. Remove the panel of the AC input at the back of the cabinet.
 4. Pass the power cord through the lead hole of the panel and connect it to the branch terminal in the cabinet (from left to right, L1, L2, L3, PE).
 - a. The three color line wires of red/green/yellow (or brown/black/gray) correspond to L1, L2, and L3 respectively. Use an internal hexagonal wrench to loosen the screw of the branch terminal, and then tighten it after connecting the AC input cable.
 - b. The yellow-green wire is grounding wire, which is connected to the protective grounding terminal (PE).
 5. Install the panel back in place.
 6. Refer to the suggestion connection diagram, connect the other end of the power cable to the required AC distribution box.

- For models to be assembled in parallel by the user, see contents related to power cable connection in *IT6000 Cabinet Assembly Instruction*.

2.5 Connecting the Device Under Test (DUT)

This section describes how to connect the test cables between the instrument and DUT.

Precautions

To prevent electric shock and damage to the instrument, observe the following precautions.

WARNING

- Before connecting test cables, be sure to switch off the instrument. Power switch is in Off position, otherwise touching the output terminals on the rear panel may result in personal injury or death due to electric shock.
- To avoid electrical shock, before testing, please make sure the rating values of the testing cables, and do not measure the current that higher than the rating value. All test cables shall be capable of withstanding the maximum short circuit current of the instrument without causing overheat.
- If several loads are provided, each pair of load wires shall safely withstand the rated short circuit output current of the power supply under full load.
- Do not short the battery when connecting or disconnecting the battery testing circuit. Short circuit may cause severe accident.
- Because the instrument can be used to sink current, hazardous voltages from an external energy source such as a battery may be present on the output terminals even with the instrument power off. Provision must be made to disconnect the external energy source before touching the output or sense terminals.
- Always use test cables provided by ITECH to connect the equipment. If test cables from other factories are used, please confirm the maximum current that the test cables can withstand.
- During wiring, check that the positive and negative poles of the test cables are properly and tightly connected. Do not connect the positive pole and disconnect the negative pole.
- It is recommended that for battery testing, a fuse must be connected in series between the power supply and the battery to prevent short circuits caused by any problems.
- When connecting the DUT (including but not limited to battery/capacitor), it is recommended that you purchase the IT-E165A anti-reverse connection module to prevent the battery/capacitor reverse connection that may cause damage to the instrument; When there is no external auxiliary equipment connected to prevent reverse connection and anti-spark function, please pay attention to the safety of the wiring, and be careful not to reverse the battery/capacitor connection, reverse connection will cause damage to the instrument, even if it is not powered on.
- Ensure that the output terminals are either insulated or covered using the safety covers provided, so that no accidental contact with lethal voltages can occur.

Electrode introduction

The wiring apertures on the DC electrodes of the 3U model and the cabinet model are both **M8**.

Introduction of electrode protective case

Due to the update of the product, the original standard DC terminal protection cover of the 3U model will be changed to an electrode insulation protection case. The protective case can completely seal the electrode, and the safety is better.



Note

6U models and cabinet models are not involved in this change.

The appearance and detailed size information of the protective case are as follows:

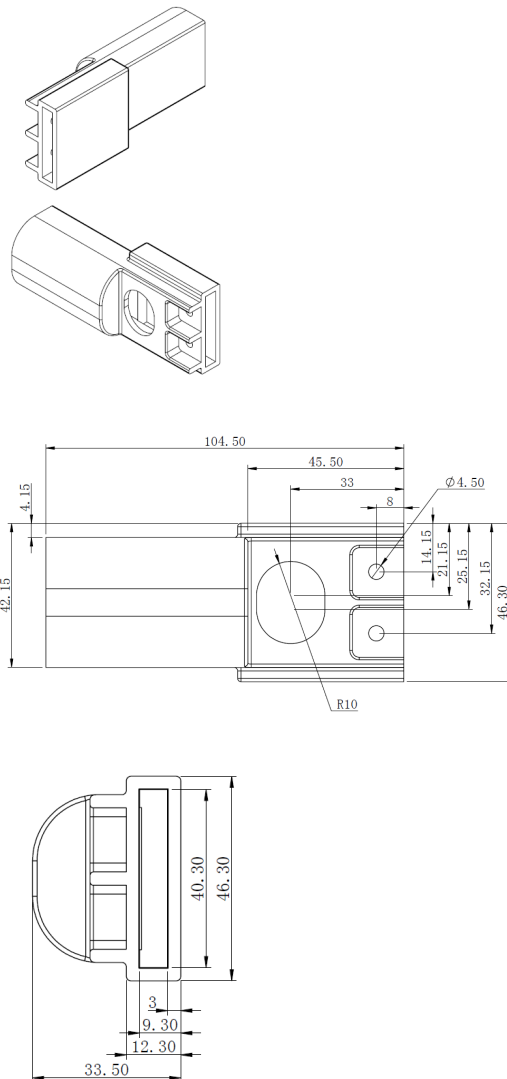

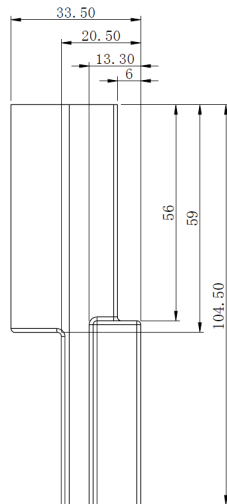

The method of use is as follows:

 **Note**

This chapter includes the use of protective cover and protective case. The description in **Connecting the DUT** mainly focuses on using the protective cover. If it is actually a protective case, please refer to the following introduction.

1. Remove the metal screw on the electrode.
2. Put on the electrode protection case, connect to the terminal of the test lead (such as the European terminal), and fasten the matching screw with an insulating nut.

 **Note**

If desired, a set of washers can be added between the insulating screw and the electrode.

The installation is completed as shown in the figure below.

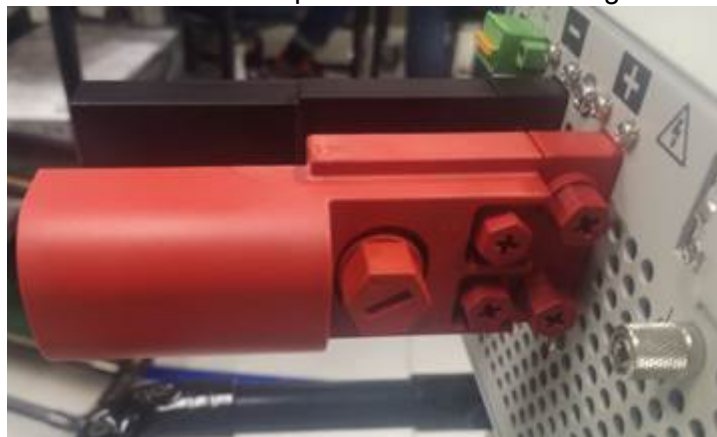

Specification for Test Cables

Test cables are not standard accessories for the instrument. Please select optional red and black test cables for individual sales based on the maximum current value. For specifications of test cables and maximum current values, refer to [A.1 Appendix→Specifications of Red and Black Test Lines](#).

Connecting the DUT (Local Measurement)

The instrument supports two kinds of wiring methods with the DUT: local measurement and remote measurement (SENSE). The default test mode is local measurement.

The connection diagram and steps of local measurement are as follows:

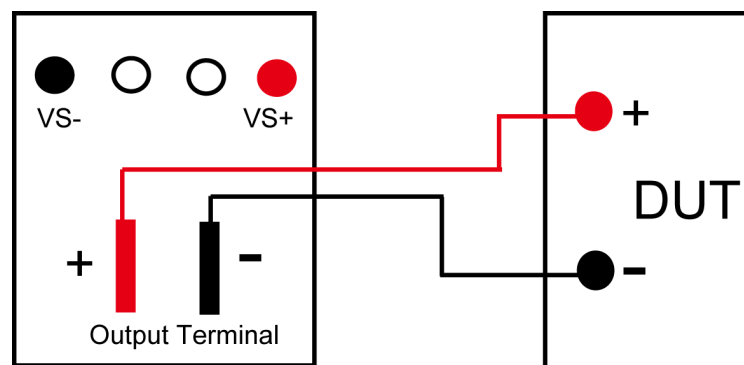

1. Confirm that the power switch is in the OFF position and verify that there is no dangerous voltage on the connection terminals.
2. Remove the output terminals cover of the power supply.
3. Loosen the screws of the output terminals and connect the red and black test cables to the output terminals. Re-tighten the screws.

When maximum current that one test cable can withstand fails to meet the rated current, use multiple pieces of red and black test cables. For example, the maximum current is 1,200A, then 4 pieces of 360A red and black cables are required.

4. Thread the red and black test cables through the output terminals cover of the power supply and install the cover.
5. (Optional) According to the actual situation of DUT, connect the grounding terminal on the rear panel of the instrument to the DUT to ensure the safe grounding.

For the location information, see [1.5 Rear Panel Introduction](#).

6. Connect the other end of the red and black cables to the DUT. The positive and negative poles must be properly connected and fastened when wiring.

Connecting the DUT (Remote Sensing)

Remote measurement is available for the following scenarios:

When the DUT consumes large current or the wires are too long, there is a voltage drop on the wires between DUT and output terminals of the power supply. To maximize measurement accuracy, the power supply provides the remote measurement terminals VS+ and VS- on the rear panel, which can be used to measure the terminal voltage of the DUT.

When the power supply is used for battery testing in actual applications, the voltage drop of the wire will lead to voltage inconsistency of both ends and inconsistency of the cutoff voltage of power supply and the actual voltage of battery, resulting in inaccurate measurement.

The connection diagram and steps of remote measurement are as follows:

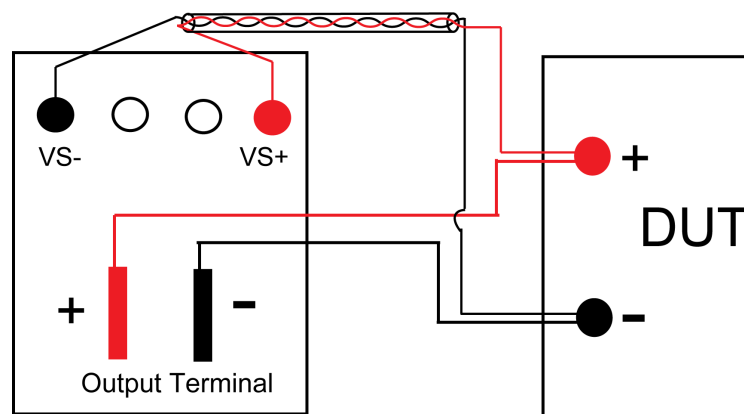

1. Confirm that the power switch is in the OFF position and verify that there is no dangerous voltage on the connection terminals.
2. Refer to the wiring diagram and connect the Vs+ and Vs- with shielded twisted-pair cables.

Note

To ensure the stability of the system, use shielded twisted-pair cables between the remote sense terminals and the DUT. Pay attention to the positive and negative poles when wiring, otherwise it will damage the instrument.

3. Remove the output terminals cover of the power supply.
4. Loosen the screws of the output terminals and connect the red and black test cables to the output terminals. Re-tighten the screws.

When maximum current that one test cable can withstand fails to meet the rated current, use multiple pieces of red and black test cables. For example, the maximum current is 1,200A, then 4 pieces of 360A red and black cables are required.

5. Thread the red and black test cables through the output terminals cover of the power supply and install the cover.
6. (Optional) According to the actual situation of DUT, connect the grounding terminal on the rear panel of the instrument to the DUT to ensure the safe grounding.

For the location information, see [1.5 Rear Panel Introduction](#).

7. Connect the other end of the remote sense cables to the DUT.

8. Connect the other end of the red and black cables to the DUT. The positive and negative poles must be properly connected and fastened when wiring.
9. Power on the instrument and turn on the Sense function of the instrument.
For details, see [5.7 Sense Function \(Sense\)](#).

WARNING

Never touch cables or connections immediately after turning off the instrument at the end of the test. Lethal voltages may remain at the output terminals after turn-off. Verify that there is no dangerous voltage on the output or sense terminals before touching them.

2.6 Remote Interface Connection

This series power supply comes standard with four communication interfaces: USB, LAN and CAN, and supports two optional communication interfaces: GPIB, RS-232. You can choose one of them to communicate with your computer.



Note

When you use the remote interface to send SCPI instructions, if you use the programming commands that involve modifying the instrument settings, such as modifying the output voltage value, after completing the communication connection between the instrument and the host computer, and after the communication settings are completed, you must execute the **SYST:REM** command firstly.

2.6.1 USB Interface

The USB interface is located on the rear panel of the instrument. You can connect the instrument to the computer via a cable with a USB interface on both ends (USB A-type connector on one end and USB B-type connector on the other).

The user needs to select the USB interface type in the System menu before using the USB interface. The following types are optional.

- TMC: USB_TMC interface;
- VCP: Virtual serial port. For Win7 system, you can download IT6000 VCP driver from ITECH official website or contact technical support engineer; for Win10 system, you do not need to install VCP driver.

The operation steps to change the USB interface type in System Menu are as follows.

1. Press the composite keys **[Shift]+[P-set]** (System) on the front panel to enter the system menu.
2. Rotate the knob or press the Up/Down key to select **I/O** and press **[Enter]**.
3. Rotate the knob or press the Left/Right key to select **USB**, and press **[Enter]**.
4. Rotate the knob or press the Left/Right key to select the communication method.

Note

If you select **VCP**, you also need to set the baud rate and other parameters of the virtual serial port, and the baud rate must be the same as the configuration on the computer side.

2.6.2 LAN Interface

When the user connect PC through LAN interface, the following is required to use the LAN interface. The LAN interface complies with the LXI standard.

Connect Interface

Use the following steps to quickly connect your instrument to your LAN and configure it. Two typical LAN interface systems are described below: private LAN and site LAN.

- **Connect to the private LAN**

A private LAN is a network in which LAN-enabled instruments and computers are directly connected. They are typically small, with no centrally-managed resources. When connected to a computer, a standard network cable can be used to connect directly to the computer via the LAN interface.

- **Connect to the site LAN**

A site LAN is a local area network in which LAN-enabled instruments and computers are connected to the network through routers, hubs, and/or switches. They are typically large, centrally-managed networks with services such as DHCP and DNS servers. When connected to a computer, a network cable can be used to connect to the router, and the computer is also connected to the router.

Note

- When using one crossover cable to connect PC directly, the gateway address of the instrument should be consistent with that of the PC, and the IP address should be at the same network segment with the PC's IP address.
- When the instrument and computer are connected to the router, an independent IP address must be assigned for the instrument.

View LAN Interface Information

The operation steps to view the LAN interface information in the System Menu are as follows.

1. Press the composite keys **[Shift]+[P-set]** (System) on the front panel to enter the system menu.
2. Rotate the knob or press the Up/Down key to select **I/O** and press **[Enter]**.
3. Press the Left/Right key to select **LAN** and press **[Enter]**.
4. Press the Left/Right key to select **Info** and press **[Enter]**.
5. Press the Up/Down key or rotate the knob to view the LAN parameters.

Configure LAN Interface Information

The configurable parameters of the IT6000C series power supply are described as follows.

IP-Conf

- **IP:** This value is the Internet Protocol (IP) address of the instrument. An IP address is required for all IP and TCP/IP communications with the instrument. An IP Address consists of 4 decimal numbers separated by periods. Each decimal number ranges from 0 through 255 with no leading zeros (for example, 169.254.2.20).
- **Mask:** This value is used to enable the instrument to determine if a client IP address is on the same local subnet. The same numbering notation applies as for the IP Address. When a client IP address is on a different subnet, all packets must be sent to the Default Gateway.
- **Gateway:** This value is the IP Address of the default gateway that allows the instrument to communicate with systems that are not on the local subnet, as determined by the subnet mask setting. The same numbering notation applies as for the IP Address. A value of 0.0.0.0 indicates that no default gateway is defined.
- **DNS1:** This field enters the primary address of the server. Contact your LAN administrator for server details. The same numbering notation applies as for the IP Address. A value of 0.0.0.0 indicates that no default server is defined.

DNS is an internet service that translates domain names into IP addresses. It is also needed for the instrument to find and display its hostname assigned by the network. Normally, DHCP discovers the DNS address information; you only need to change this if DHCP is unused or not functional.

- **DNS2:** This field enters the secondary address of the server. Contact your LAN administrator for server details. The same numbering notation applies as for the IP Address. A value of 0.0.0.0 indicates that no default server is defined.
- **Socket Port:** This value indicates the port number corresponding to the service.

Serv-Conf

Configurable services include: MDNS, PING, Telnet-scpj, Web, VXI-11, and Raw Socket.

How to Configure

- **IP-Conf**

Take manual configuration as an example. The steps are as follows:

1. Press the composite keys **[Shift]+[P-set]** (System) on the front panel to enter the system menu.
2. Rotate the knob or press the Up/Down key to select **I/O** and press **[Enter]**.
3. Press the Left/Right key to select **LAN** and press **[Enter]**.
4. Press the Left/Right key to select **IP-Conf** and press **[Enter]**.
5. Press the Left/Right key to select **Manual** and press **[Enter]**.
6. Set the **IP**, **Mask** and the other parameters in turns, and press **[Enter]**.

After the last parameter **Socket Port** is set, the system will return to the LAN setting interface shown as below:

```
SYSTEM  I/O CONF  LAN
Info  IP-Conf  Serv-Conf  Reset
```

7. Press the Left/Right key to select **Reset** to confirm the settings of IP-Conf.

- **Serv-Conf**

1. Press the composite keys **[Shift]+[P-set]** (System) on the front panel to enter the system menu.
2. Rotate the knob or press the Up/Down key to select **I/O** and press **[Enter]**.

3. Press the Left/Right key to select **LAN** and press **[Enter]**.
4. Press the Left/Right key to select **Serv-Conf** and press **[Enter]**.
5. Rotate the knob to select the service you want to enable and press **[Enter]**.
6. Rotate the knob to select whether to enable the service and press **[Enter]**.
 - On: Indicates that the service is enabled.
 - Off: Indicates that the service is disabled.

2.6.2.1 Using Web Server

The instrument has a built-in Web server for monitoring and controlling the instrument via a Web browser in PC. To use the Web server, connect the instrument and PC over LAN interface and enter the instrument's IP address into the address bar at the top of your PC's Web browser, you can access the front panel control functions including the LAN configuration parameters.



Note

- If you want to remotely control the instrument using the built-in web server, you must enable the web service. See [2.6.2 LAN Interface](#) for details.
- The format of the address entered in the address bar of the browser is **http://192.168.0.100**. The specific IP address is subject to the actual instrument settings.

The opened page is displayed as follows:

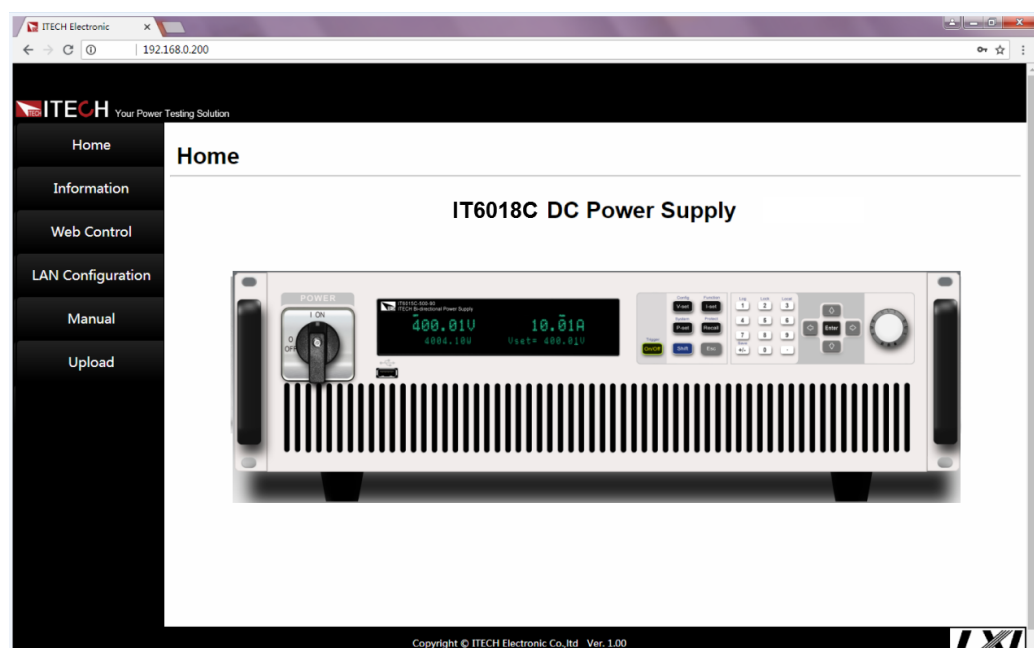

Note

The homepage of different models are different. The actual shown page shall be subject to the connected instrument.

You can select different pages by clicking the buttons shown in the navigation bar on the left side of the window. The detailed descriptions are as follows.

- Home : Web home interface, displays the model and appearance of the instrument;
- Information: Displays the serial number of the instrument and more system information as well as LAN configuration parameters;
- Web Control: Enables the Web control to begin controlling the instrument. This page allows you to monitor and control the instrument;
- LAN Configuration: Reconfigure the LAN parameters;
- Manual: Go to the ITECH official website and view or download the relevant documents.
- Upload: Performs a system upgrade.

Click **CONNECT** to connect the PC with the instrument, then click **Select File** to select the system upgrade installation package (for example, `itech_6000_P.itech`), and then click **UPLOAD** performs the upgrade operation. After the upgrade is complete, the instrument needs to be restarted.

2.6.2.2 Using Telnet

The Telnet utility (as well as sockets), is another way to communicate with the instrument without using I/O libraries or drivers. In all cases, you must first establish a LAN connection from your computer to the instrument as previously described.

In an MS-DOS Command Prompt box, type “telnet hostname” where hostname is the instrument’s hostname or IP address. Press the Enter key and you should get a Telnet session box with a title indicating that you are connected to the instrument and 23 is the instrument’s telnet port. Type the SCPI commands at the prompt.

2.6.2.3 Using Sockets

CAUTION

- **Before using this function, you need to configure Socket Port, and the configuration on the instrument side should be consistent with the configuration on the PC side.**
- **The instruments allow any combination of up to six simultaneous socket and telnet connections to be made.**

ITECH instruments have SCPI socket services, which can be used to send and receive SCPI commands, queries, and query responses. All commands must be terminated with a newline for the message to be parsed. All query responses will also be terminated with a newline.

2.6.3 CAN Interface

The CAN interface is located on the rear panel of the instrument and is connected to the computer using a CAN communication cable.

Definition of CAN Pins

The definition of CAN pins are as follows.

Pins	Description
H	CAN_H
L	CAN_L

CAN Configuration

The user needs to configure the CAN interface parameters in the system menu before using the remote control. The CAN interface parameters are as follows.

Name	Description
Address	Range: 0 – 127
Baud rate	Select the baud rate from the following options: 5k/10k/20k/40k/50k/80k/100k/125k/200k/250k/400k/500k/600k/800k/1000k
Protocol	<ul style="list-style-type: none"> • DeviceNet: Use standard can protocol. • BMS: Use the protocol for docking with the BMS system.

The operation steps are as follows.

1. Press the composite keys **[Shift]+[P-set]** (System) on the front panel to enter the system menu.
2. Rotate the knob or press the Up/Down key to select **I/O** and press **[Enter]**.
3. Press the Left/Right key to select **CAN** and press **[Enter]**.

4. Set the baud rate, address and other parameters, press **[Enter]**.

CAN Troubleshooting

If you meet some problems when communicating with PC by CAN interface, please check the following items:

- PC and the instrument must have the same baud rate.
- Ensure you have used the correct communication cable (CAN_H, CAN_L). Please pay attention that some cable may not have a correct internal wiring even it is with an appropriate plug.
- The interface cable is correctly connected (CAN_H to CAN_H, CAN_L to CAN_L).
- If the communication signal is poor or unstable, it is recommended to connect a 120 Ω terminating resistance.
 - The connection diagram of a single device is as below.

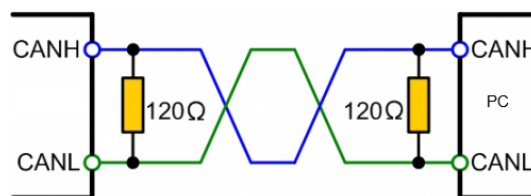

- The connection diagram of multiple devices is as below.

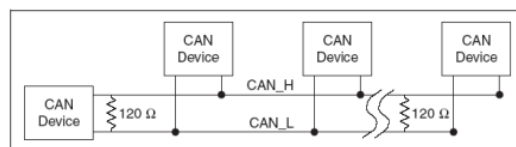

Note

When multiple devices are connected, it is recommended to connect the pin 8 (GND) of the P-IO terminal on the rear panel of these devices in parallel, and the communication quality will be improved in the entire CAN network.

2.6.4 GPIB Interface (Optional)

The GPIB (IEEE-488) interface is assembled in the IT-E166 communication board. Use a GPIB cable to connect GPIB interfaces of the instrument and PC. Please ensure that the screws have been screwed down in order to have a full connection.

GPIB Configuration

Each device on the GPIB (IEEE-488) interface must have a unique whole number address between 1 and 30. Your computer's GPIB interface card address must not conflict with any instrument on the interface bus. This setting is non-volatile; it will not be changed by *RST.

When you purchase the interface accessory and successfully insert it into the corresponding position on the rear panel of the instrument, the menu item for changing the GPIB address appears in the System menu. The specific steps are as follows:

1. Ensure that the instrument's power switch is off, that is, the instrument is in Power Off state.
2. Insert the separately purchased GPIB interface card into the card slot on the rear panel of the instrument.
3. Connect the instrument with the computer via the GPIB cable. After the connection is successful, turn on the power switch of the instrument.
4. Press the composite keys **[Shift]+[P-set]** (System) on the front panel to enter the system menu.
5. Rotate the knob or press the Up/Down key to select **I/O** and press **[Enter]**.
6. Press the Left/Right key to select **GPIB** and press **[Enter]**.
7. Press the numeric keys to set the GPIB address and press **[Enter]**.

2.6.5 RS-232 Interface (Optional)

The RS-232 interface shares the same communication card (IT-E167) with the analog function.

Definition of RS-232 Pins

The definition of RS-232 pins are as follows.

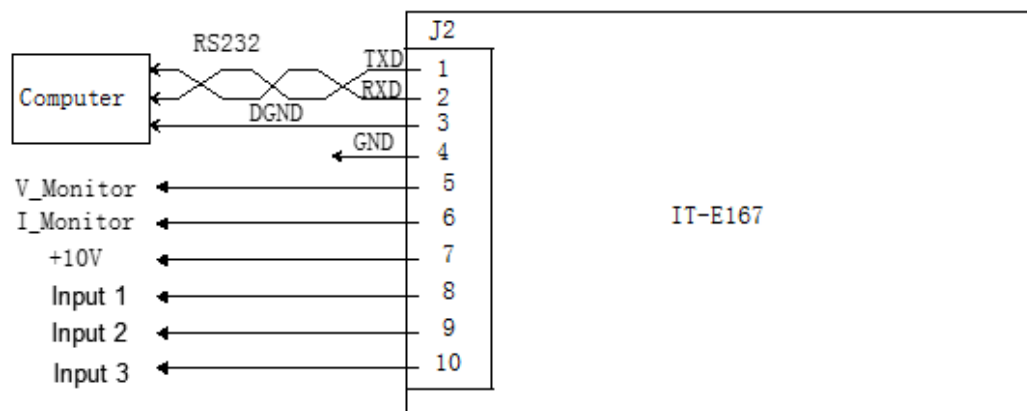

When using the RS-232 interface for communication, connect the pin 1, pin 2, and pin 3 of the IT-E167 to the PC. The pin description is as follows:

Pins	Description
1	TXD, transmit data
2	RXD, receive data
3	DGND, ground

RS-232 Configuration

When you purchase the interface accessory and successfully insert it into the corresponding position on the rear panel of the instrument, the RS-232 menu item will appear in the System menu. The specific steps are as follows:

1. Ensure that the instrument's power switch is off, that is, the instrument is in Power Off state.
2. Insert the separately purchased RS-232 interface card into the card slot on the rear panel of the instrument.
3. Connect the instrument to the computer via an RS-232 cable. After the connection is successful, turn on the power switch of the instrument.
4. Press the composite keys **[Shift]+[P-set]** (System) on the front panel to enter the system menu.
5. Rotate the knob or press the Up/Down key to select **I/O** and press **[Enter]**.
6. Press the Left/Right key to select **RS232** and press **[Enter]**.
7. Set the relevant communication parameters in turn, and press **[Enter]**.

The RS-232 interface parameters are as follows.

Name	Description
Baud rate	Select the baud rate from the following options: 4800/9600/19200/38400/57600/115200
Data Bit	The options are: 5/6/7/8
Parity bit	The options are: N (no parity), O (odd parity), E (even parity).
Stop bit	The options are: 1/2

RS-232 Troubleshooting

If you meet some problems when communicating with PC by RS-232 interface, please check the following items:

- Check that whether the baud rate of the computer and instrument are the same;
- Make sure the correct cable and adapter are connected. Note that internal wiring may not be correct even if the cable has a suitable plug;
- The cable must be connected to the correct serial ports (COM1, COM2, etc) of PC.

3 Getting Started

- ◆ Power-on Self-Test
- ◆ Set Output Value
- ◆ Use the Front Panel Menu.
- ◆ On/Off Control

3.1 Power-on Self-Test

Before operation, please confirm that you have fully understood the safety instructions.

When you turn the POWER switch on for the first time after purchase, the instrument starts with its factory default settings. Each time thereafter, the instrument starts according to the setting that you selected as outlined in [5.6 Set the Power-on State \(PowerOn\)](#).

Precautions

WARNING

- Before connecting power cord, be sure to confirm that the power voltage matches with the supply voltage.
- Before connecting power cord, be sure to switch off the instrument. Verify that there is no dangerous voltage on the terminals before touching them.
- To avoid fire or electric shock, make sure to use the power cord supplied by ITECH.
- Be sure to connect the main power socket to the power outlet with protective grounding. Do not use terminal board without protective grounding.
- Do not use an extended power cord without protective grounding, otherwise the protection function will fail.
- Be sure to perform related operations and connections to feed energy back to grid in accordance with related regulations, and meet all necessary conditions.
- Ensure that the input electrodes are either insulated or covered using the safety covers provided, so that no accidental contact with lethal voltages can occur.
- If you notice strange sounds, unusual odors, fire, or smoke around or from inside the instrument, flip the POWER switch to the (O) side to turn the instrument off, or remove the power cord plug from the outlet. The detachable power cord may be used as an emergency disconnecting device. Removing the power cord will disconnect AC input power to the unit.

Power Switch Introduction

User can adjust the power switch directly to turn on or turn off the instrument.

The status of Power switch is as follows.



On



Off



On



Off

If the instrument is the cabinet type, the rear panel of the cabinet provides a master power switch. The relationships between the device status and switch status are listed in the following table.

Master switch status	Desperate switch status	Device status
On	On	On
On	Off	Off
Off	On	Off
Off	Off	Off

Turning the POWER Switch On / Off

- Turning the POWER Switch On
Check that the power cord is connected properly.
Flip the POWER switch to the (|) side to turn the instrument on. The front panel display will light up after a few seconds. It may take about 30 seconds or so for the power supply to initialize before it is ready for use.
- Turning the POWER Switch Off
Flip the POWER switch to the (O) side to turn the instrument off. After you turn the POWER switch off, wait at least 10 seconds after the fan stops before you turn the POWER switch back on. Turning the instrument on too soon after you turn it off can cause damage to the inrush current limiter circuit, as well as reduce the life of components such as the POWER switch and the internal input fuses.

Self-Test Procedures

A successful self-test indicates that the purchased product meets delivery standards and it is available for normal usage. Normal self-test procedures:

1. Correctly connect the power cord and power on the instrument.
The instrument starts the self-test.
2. After the instrument is self-tested normally, the VFD shows the output voltage, current, power and other information (CV mode).

If an error occurs during the self-test, an error message is displayed. The following table lists the error messages you might see.

Error message	Error Description
Eeprom Failure	The EEPROM is damaged.
Main FrameInitializeLost	The system setting data is lost.
Calibration Data Lost	The factory calibration data in EEPROM is lost.
Config Data Lost	The latest operation state of the instrument is lost.
NETWORKING...	The parallel operations are abnormal and cannot finish the networking.
FIBER MULTI MASTER	Multi-master conflict
FIBER EXT UNLOCK	The outer ring of the fiber is not locked.
FIBER INNER UNLOCK	The inner ring of the fiber is not locked.

Exception Handling

If the instrument cannot start normally, please check and take measures by reference to steps below.

1. In order to facilitate the transportation and protection of the fiber optic cable, the fiber optic cable required for communication between the two single units (one master and one slave) of the 6U model is removed at the factory and packaged separately as an accessory. Before you turn on the power of the device, you need to connect the fiber cable as shown in the figure below, and then perform the power-on operation.

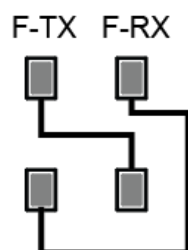

2. Check whether the power cord is correctly connected and confirm whether the instrument is powered.
3. Check whether the power is On. The power switch is under “|” On status.

4. Check whether the power voltage matches with the supply voltage. Please refer to [2.4 Connecting the Power Cord](#) to select proper AC input.
5. After multiple units are connected in parallel and powered on, the error related to the fiber-optic is indicated. Please refer to the following steps for troubleshooting.
 - **FIBER MULTI MASTER:** Multiple units (with panel) are connected in parallel, please confirm whether multiple Masters are set. Select **System**→**Parallel** menu to reset. There can only be one single unit as the Master, and the other single units must be set to Slave. After the setting is completed, power off and restart each single unit.
 - **FIBER EXT UNLOCK:** Multiple units (with panel) are connected in parallel, check whether the cable connection of the fiber outer ring (TX and RX) is closed. Then confirm that whether the **System**→**Parallel** menu is set. There can only be one single unit as the Master, and the other single units must be set to Slave. After the setting is completed, power off and restart each single unit.
 - **FIBER INNER UNLOCK:** Only one master unit (with panel) and the rest is slave unit (without panel) connected in parallel, firstly, confirm whether the cable connection of the fiber inner ring (F-TX and F-RX) is closed. Then confirm that whether the **System**→**Parallel** menu is set. If yes, please restore the setting to **Single** mode, then power off and restart. Then consult ITECH technical support engineers for the parallel setting method in this case.
6. If the instrument still does not start, contact ITECH technical support engineer.

3.2 Set Output Value

The voltage value, current value, power value can all be programmed. The user can set different output parameters within the range of specifications according to the need to satisfy a range of test requirement.

After selecting the operation mode, the interface displays the setting value under the selected operation mode and the cursor blinks to prompt. The user can use the following methods to set the values.

- Directly use the number keys to set the value.
- Rotate the knob to set the data in the cursor position. Rotate the knob clockwise to increase the set value and anticlockwise to decrease the set value. Once the data in the cursor position increases to ten, the value will add one

to the front position automatically. and once the data in the cursor position decreases to zero, the value will minus one from the front position automatically. This provides convenience for the user to set. The knob can works with the left or right keys. Use the left or right keys to move the cursor position.



Note

After entering the menu interface, the knob can also be used to scroll pages to view menu items.

3.3 Use the Front Panel Menu.

The front panel provides multiple menu keys and the user can access the instrument menu by using the front panel keys, including **Config** menu, **System** menu, **Protect** menu and **Function** menu. And the user can change the related system setting in the menu. Each menu is briefly described as follows.

- The user can set the parameters related to electrical properties in the **Config** menu, including the current operation mode, slope, output delay time, internal resistance.
- The user can set the function related to instrument system in the **System** menu, including the key beeper, Sense function, power-on state, trigger source, communication method, data logger method, digital I/O function setting, parallel function, system information and so on.
- The user can set the parameters related to instrument protection function in the **Protect** menu, including OCP /OVP/OPP /UCP/UVP.
- **Function** menu includes output list, batterycharging test function and so on.

The user press the complex keys to enter into the menu interface. The menu is divided according to the function item and the corresponding operation is set in the lowest level menu item. For example, the key beeper is set in **System**→**Beep**. Set the **Beep** item to off or on. Please refer to [1.7 Configuration Menu Function](#), [1.8 System Menu Function](#) and the corresponding chapters for detailed menu description.

After entering the menu interface, the screen displays the optional menu. Rotate the knob or press left or right keys to view the menu items. When the number in front of the menu item is blinking, indicates this item is selected currently. Press **[Enter]** key to enter the selected menu item and press **[Esc]** to exit the menu.

3.4 On/Off Control

WARNING

- The [On/Off] key is used to turn the output/input on or off under normal circumstances. Even if the instrument is in control by PC or the keyboard is locked, the [On/Off] is still valid.
- The [On/Off] key light is off and turning the output off does not place the instrument in a safe state. Hazardous voltages may be present on all output and guard terminals. Putting the equipment into an output-off state does not guarantee that the outputs are powered off if a hardware or software fault occurs. See the cautions about connecting the test lines before connecting test lines.

Controlled by the [On/Off] key

You can press the [On/Off] key on the front panel to control the output status of the power supply. If the [On/Off] key light is on, indicates that the output is turned on. If the [On/Off] key light is off, indicates that the output is turned off. When the output of the power supply is on, the operating status flag (CV/CC/CW) on the VFD will be illuminated.



Note

It is recommended that you turn on the [On/Off] after the power supply is connected to the DUT. If the power supply has no output after the output is turned on, check the voltage and current setting value, set the voltage and current to a non-zero value, and then turn on the output.

Controlled by remote command

When communicating remotely, the [On/Off] switch of the power supply or load can be controlled by using the corresponding SCPI command, as detailed in the programming guide. For example, for IT6000C series, use **OUTP 1** to turn on the power output; for IT8000 series, use **INP 1** to turn on the load input.

Controlled by Digital IO pins

The Digital IO pin, which comes standard with this series of instruments, supports external level/pulse signal control output, and in combination with external circuitry, enables DC emergency stop control of the output. Refer to the following use case.

Case:

Pin 5 of Digital IO, with the function of INTERLOCK, can disable the output of DC side by inputting low level (0V) to pin 5 in the default **Not-Invert, INH-Living** setting, at which time the **[On/Off]** key light is on and there is no actual output. Restoring a high level (5V) on pin 5 restores the output on the DC side.

1. Go to the **System**→**Digital Port**→**IO-5. INH-Living Not-Invert** menu.
2. Select the **Not-Invert** and **INH-Living** items, and press **[Enter]** to confirm.
3. Connect Pin5 (positive) and Pin8 (negative) of Digital IO to the external signal control circuit.

At this time, 5V is output between Pin5 and Pin8.

4. After connecting the DUT, turn on **[On/Off]**.
5. Input 0V to Pin5 (positive) and Pin8 (negative), or directly short Pin5 and Pin8.

At this point, output is disabled.

6. Input 5V to Pin5 (positive) and Pin8 (negative), or disconnect the short wire between Pin5 and Pin8.

At this point, output is restored.

4 Power Supply Function

This chapter describes the functions and features of the power supply. Divided into the following sections:

- ◆ Set the Output Voltage
- ◆ Set the Output Current
- ◆ Set the Output Power
- ◆ Config Menu for Power Supply
- ◆ Protection Function for Power Supply
- ◆ Function Menu for Power Supply

4.1 Set the Output Voltage

In CV priority (default) mode, press **[V-set]**, the interface displays “Vs=0.00V” (Setting value of voltage). In CC priority mode, press **[V-set]**, the interface displays “Vh=0.00V” (Upper limit of voltage), and press **[V-set]** again, the interface displays “Vl=0.00V” (Lower limit of voltage).

The voltage setting range is from 0V to the maximum rated output voltage. When **[V-set]** key is pressed, the key light is lit and the output voltage value can be set. Press numeric keys or rotate the knob to adjust the value in the voltage setting area indicated by the cursor. This value takes effect when you press **[Enter]**.

4.2 Set the Output Current

In CV priority (default) mode, press **[I-set]**, the interface displays “I+=0.00A” (Upper limit of current), and press **[I-set]** again, the interface displays “I-= – 0.00 A” (Lower limit of current). In CC priority mode, press **[I-set]**, the interface displays “Is=0.00A” (Setting value of current).

The range of current settings is between the data ranges defined in the specifications. When **[I-set]** key is pressed, the key light is lit and the output current value can be set. Press numeric keys or rotate the knob to adjust the value in the current setting area indicated by the cursor. This value takes effect when you press **[Enter]**.

**Note**

For the bi-directional power supply, you can set the direction of the current (output / input), that is, control the positive or negative current value by pressing the [+/-] key.

4.3 Set the Output Power

Press **[P-set]**, the interface displays “P+=0.00W” (Upper limit of power) , and press **[P-set]** again, the interface displays “P- = – 0.00W” (Lower limit of power)

The range of power settings is between the data ranges defined in the specifications. When **[P-set]** key is pressed, the key light is lit and the output power value can be set. Press numeric keys or rotate the knob to adjust the value in the power setting area indicated by the cursor. This value takes effect when you press **[Enter]**.

**Note**

For the bi-directional power supply, you can set the direction of the power (output / input), that is, control the positive or negative power value by pressing the [+/-] key.

4.4 Config Menu for Power Supply

In this chapter, the setting items under the configuration menu are described in detail.

4.4.1 Set the CC/CV Priority Mode

CV Priority

In CV priority mode, the output is controlled by a constant-voltage feedback loop, which maintains the output voltage at its programmed setting as long as the load current remains within the positive or negative current limit settings. CV priority mode is best suited for use with resistive or high impedance loads, and loads that are sensitive to voltage overshoots. Do not use CV priority mode with low-impedance sources such as batteries, power supplies, or large charged capacitors.

In CV priority mode, the output voltage should be programmed to the desired value. A positive and negative current limit value should also be set. The current limit should always be set to a value that is greater than the actual input current requirement of the external load. The following figure shows the CV priority operating locus of the output. The area in the white quadrants shows the output as a source (sourcing power). The area in the shaded quadrants shows the output as a load (sinking power).

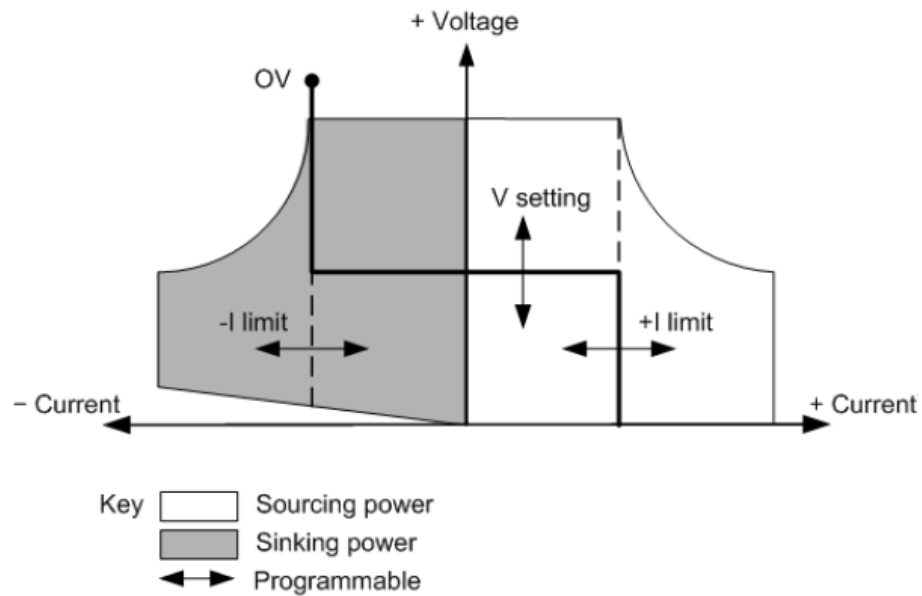

Note

In sink mode, there is a minimum operating voltage. The minimum operating voltage specification data corresponding to different voltage models are as follows.

Voltage Level	Sink Current	Minimum Operating Voltage (MOV)	MOV/Vmax (%)
80V	-I _{max}	0.8V	1%
300V	-I _{max}	1.8V	0.6%
500V	-I _{max}	2.5V	0.5%
800V	-I _{max}	4V	0.5%
1500V	-I _{max}	7.5V	0.5%
2250V	-I _{max}	11.25V	0.5%

*The data in the above table is the actual measurement of Main Version V00.006.011 and above. For other version of the firmware, contact ITECH technical support.

The heavy solid line illustrates the locus of possible operating points as a function of output. As shown by the horizontal portion of the line, the output voltage remains regulated at its programmed setting as long as the load current remains within the positive or negative current limit setting. A CV status flag indicates that the output voltage is being regulated and the output current is within its limit settings.

Note that when the output current reaches either the positive or negative current limit, the unit no longer operates in constant voltage mode and the output voltage is no longer held constant. Instead, the unit will now regulate the output current at its current limit setting.

As shown by the vertical portions of the shaded quadrants, the output voltage may continue to increase in the positive direction or decrease in the negative direction as current is forced into or pulled out of the unit. When the output voltage exceeds the over-voltage protection setting, the output will shut down.

CC Priority

In CC priority mode, the output is controlled by a bi-polar constant current feedback loop, which maintains the output source or sink current at its programmed setting. The output current remains at its programmed setting, provided the load voltage remains within the voltage limit setting. CC priority mode is best suited for use with batteries, power supplies, large charged capacitors, and loads that are sensitive to current overshoots. It minimizes current overshoots during programming, turn-on, and turn-off transitions and seamlessly transitions between positive and negative currents.

In CC priority mode, the output current should be programmed to the desired positive or negative value. A positive voltage limit range should also be set. The voltage upper limit should always be set to a value that is greater than the actual input voltage requirement of the external load. The following figure shows the CC priority operating locus of the output. The area in the white quadrants shows the output as a source (sourcing power). The area in the shaded quadrants shows the output as a load (sinking power).

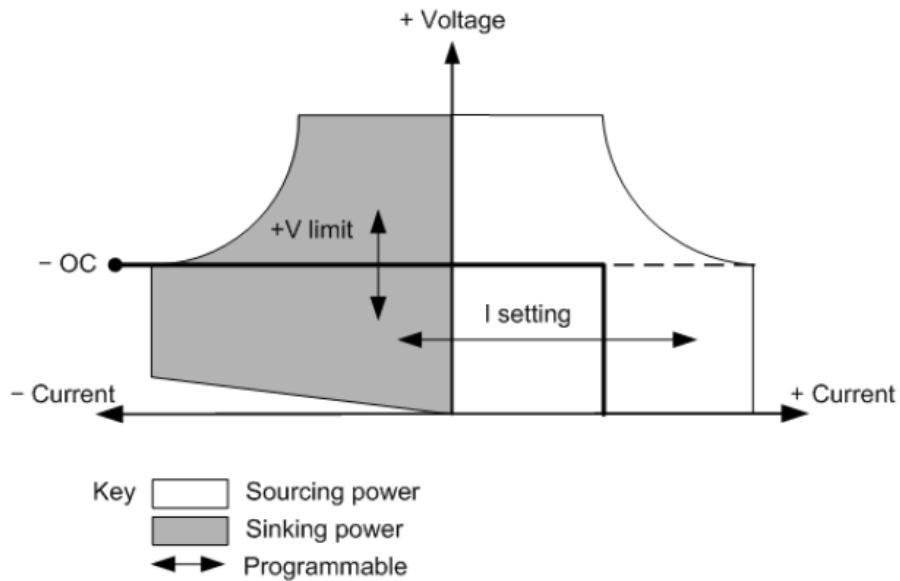

Note

In sink mode, there is a minimum operating voltage. The minimum operating voltage specification data corresponding to different voltage models are as follows.

Voltage Level	Sink Current	Minimum Operating Voltage (MOV)	MOV/Vmax (%)
80V	-I _{max}	0.8V	1%
300V	-I _{max}	1.8V	0.6%
500V	-I _{max}	2.5V	0.5%
800V	-I _{max}	4V	0.5%
1500V	-I _{max}	7.5V	0.5%
2250V	-I _{max}	11.25V	0.5%

*The data in the above table is the actual measurement of Main Version V00.006.011 and above. For other version of the firmware, contact ITECH technical support.

The heavy solid line illustrates the locus of possible operating points as a function of output. As shown by the vertical portion of the line, the output current remains regulated at its programmed setting as long as the output voltage remains within its limit setting. A CC (constant current) status flag indicates that the output current is being regulated and the output voltage is within its limit settings.

Note that when the output voltage reaches the upper limit, the unit no longer operates in constant current mode and the output current is no longer held

constant. Instead, the unit will now regulate the output voltage at its voltage limit setting.

As shown by the horizontal portion of the shaded quadrants, when the unit is sinking power, the output current may continue to increase in the negative direction as more current is forced into the unit. This can happen when the instrument is connected to an external device such as a battery, and its output voltage is higher than the voltage limit setting of the instrument. Once the current exceeds the built-in negative over-current limit, the output will shut down. In such a case, it is important to set the voltage limit properly in order prevent this protection shutdown.

How to Set

The procedures to set the output priority mode are as follows.

1. Press the composite keys **[Shift]+[V-set]** (Config) on the front panel to enter the configuration menu.
2. Select **Mode** and press **[Enter]** to enter into the setting interface.
3. Select **CC** or **CV**, and press **[Enter]**.
Enter the setting interface of the loop response speed.
4. Select **High** or **Low**, and press **[Enter]**.
At this point, return to the Config menu settings interface.
5. Press the down arrow key to set the voltage/current rise time. When finished, press **[Enter]**.
6. Set the other Config menu items in the same way.
7. Set the output voltage and current value.
 - CV priority
 - a. Press the **[V-set]** key on the front panel to set the output voltage value **Vs**.
 - b. Press the **[I-set]** key on the front panel to set the current upper limit **I+**. Press **[I-set]** again to set the current lower limit **I-**, i.e. the negative current limit value.
 - CC priority
 - a. Press the **[I-set]** key on the front panel to set the output current value **Is**.
 - b. Press the **[V-set]** key on the front panel to set the voltage upper limit **Vh**, and press **[V-set]** again to set the voltage lower limit **VI**.

4.4.2 Set the Internal Resistance

The IT6000C series power supply provides internal resistance setting (CV priority mode only). The procedures are shown as below.

1. Press the composite keys **[Shift]+[V-set]** (Config) on the front panel to enter the configuration menu.
2. Press the up/down key or rotate the knob to select **Output Res** and press **[Enter]** to confirm.
3. Set the internal resistance value and press **[Enter]** to confirm.

4.4.3 CR Function in Sink Mode

This series of instruments supports CR testing in sink mode, and the sink current capability of CR is controlled by the I_s setting value in CC priority mode. The usage of this function is as follows:

1. Press the composite keys **[Shift]+[V-set]** (Config) on the front panel to enter the configuration menu.
2. Select **Mode** and press **[Enter]**.
3. Select **CC** and press **[Enter]**.

Enter the setting interface of the loop response speed.

4. Select **High** or **Low**, and press **[Enter]**.

At this point, return to the Config menu settings interface.

5. Press the down arrow key to set the current rise and fall time.
6. Press the down arrow key to select **Sink Res** and press **[Enter]**.
7. Select **On** and press **[Enter]**.
8. Set the **Sink Res** value and press **[Enter]**.

Setting range: 0~7500Ω. If set to 0, the function is equivalent to that **Sink Res** is selected as **OFF**.

The following takes the setting of 10Ω as an example to introduce the actual test results.

9. Set the voltage and current.
 - a. Press the **[I-set]** key on the front panel to set the output current value I_s . Take -5A as an example.
 - b. Press the **[V-set]** key on the front panel to set the voltage upper limit $V_h=20V$, and press **[V-set]** again to set the voltage lower limit $V_l=0V$.
 - c. Set the DUT (power supply) to output 80V, 10A.

At this time, 10Ω in sink mode (according to the formula $I=U/R$, sink current is $80\div 10=8A$), due to the limitation of $I_s=-5A$ in CC priority mode, the actual sink current is 5A, and the instrument is working In CC mode. If **Sink Res** is set to 20Ω, the sink current is 4A, which is within the limit of I_s , so the instrument works in CR mode at this time.

4.4.4 Set the Output-On/Output-Off Delay

You can set the output-on/output-off delay time within the range from 0 seconds to 60 seconds.

- **On Delay:** Indicates from the time that a command to turn on the output is received until the output actually turns on.
- **Off Delay:** Indicates from the time that a command to turn off the output is received until the output actually turns off.

The procedures to set the output delay time are as follows.

1. Press the composite keys **[Shift]+[V-set]** (Config) on the front panel to enter the configuration menu.
2. Press the up/down key or rotate the knob to select **On Delay** or **Off Delay**, and press **[Enter]** to confirm.
3. Set the output-on/output-off delay time and press **[Enter]** to confirm.

4.5 Protection Function for Power Supply

The IT6000C series power supply provides the general protection functions such as overvoltage, overcurrent, overpower, undercurrent and undervoltage protection. The corresponding protection parameters can be configured in the Protect menu. In addition, the power supply also provides over temperature protection and Sense reverse connection protection.

The descriptions of Protect menu are listed in the table below.

Protect	Protection function menu for the power supply			
	OVP	Overvoltage protection		
		Off	Turn the OVP function off. (Def)	
		On	Turn the OVP function on.	
			Level	OVP limit
			Delay	Protection delay time, see Protection Delay .
	OCP	Overcurrent protection		
		Off	Turn the OCP function off. (Def)	
		On	Turn the OCP function on.	
			Level	OCP limit

			Delay	Protection delay time, see Protection Delay .
	OPP	Overpower protection		
		Off	Turn the OPP function off. (Def)	
		On	Turn the OPP function on.	
			Level	OPP limit
			Delay	Protection delay time, see Protection Delay .
	UCP	Undercurrent protection		
		Off	Turn the UCP function off. (Def)	
		On	Turn the UCP function on.	
			Warm-up	Indicates the instrument warm-up time. This time is set to prevent the instrument from triggering protection when the current is rising. Because this transient condition should not be considered as an undercurrent fault and there is no need to trigger protection.
			Level	UCP limit
			Delay	Protection delay time, see Protection Delay .
	UVP	Undervoltage protection		
		Off	Turn the UVP function off. (Def)	
		On	Turn the UVP function on.	
			Warm-up	Indicates the instrument warm-up time. This time is set to prevent the instrument from triggering protection when the voltage is rising. Because this transient

				condition should not be considered as an undervoltage fault and there is no need to trigger protection.
			Level	UVP limit
			Delay	Protection delay time, see Protection Delay .

Protection Delay

You can specify an OCP/OVP/OPP/UCP/UVP delay to prevent momentary output settings and status changes from tripping the protection. In most cases these momentary conditions would not be considered an protection fault, and having an OCP/OVP/OPP/UCP/UVP condition disable the output when they occur would be a nuisance. Specifying an protection delay (**Delay**) can ignore these momentary changes during the specified delay period. Once the delay time has expired and the protection limit condition persists, the output will shut down.

Protection Prompt

When the instrument enters the protection state, the buzzer sounds (if **Beep** menu item is set as default state **On**), the VFD status indicators **Prot** and **Off** are lit, and **[On/Off]** is turned off.

WARNING

Although [On/Off] is turned off, there may be dangerous voltage at the output electrodes. Do not touch the wiring cable or the electrode terminals.

When protection is generated, the VFD screen displays the following information:

- The first row shows the meter voltage and the meter current value.
- The left side of the second row shows the specific protection information (such as overvoltage protection OVP), the right side shows the duration of the protection (hour: minute: second) and the number of protection information in the message queue and the total number of protection information.

Users can turn the page through the knob to view all the protection information.

Clear the Protection

After the instrument triggers protection and generates a protection message, you need to troubleshoot the possible cause. When the protection is resolved, the VFD will still prompt the protection information. You can manually clear the protection information record through the following methods.

- Input a pulse signal to pin 1 of the rear panel **P-IO** to clear the protection information.
For details, see [5.11.1 IO–1. Ps-Clear, Not-Invert](#).
- Press the **[Esc]** or **[Enter]** key on the front panel to manually clear the protection information.
- Connected to the host computer, the PC sends a **PROTection:CLEar** command to the instrument to clear the protection information.

After the protection is cleared, you need to press the **[On/Off]** key on the front panel or send the **OUTPut ON** command to the instrument to reopen **[On/Off]**.

4.5.1 Set Over-Voltage Protection (OVP)

Users can enable the OVP function and set the protection limit **Level** and protection delay time **Delay**. When the voltage (i.e., the Meter value) is greater than this protection limit and the delay time is exceeded, the power supply will enter the OVP state.

Possible Cause

Many reasons can cause OVP, the details are as follows:

- The set protection limit **Level** is lower than the voltage Meter value.
- The external (AC input) inputs a higher voltage.
- The power supply outputs a high voltage due to a fault.

CAUTION

Please avoid inputting a external voltage higher than 120% rated value, or the instrument will be damaged.

How to Set

The operation steps to set OVP are as follows.

1. Press the composite keys **[Shift]+[Recall]** (Protect) on the front panel to enter the protection menu.
2. Press the up/down key or rotate the knob to select **1. OVP (Off)** and press **[Enter]**.
3. Press the left/right key or rotate the knob to select **On** and press **[Enter]** to enter the setting interface.
4. Set the protection limit **Level** and the delay time **Delay** in sequence, and press **[Enter]** to confirm.

The VFD screen returns to the Protect menu and the OVP setting (take 150V, 1S as an example) is displayed as follows:

```
PROTECT
1.OVP   150V, 1S
```

4.5.2 Set Over-Current Protection (OCP)

Users can enable the OCP function and set the protection limit **Level** and protection delay time **Delay**. When the current (i.e., the Meter value) is greater than this protection limit and the delay time is exceeded, the power supply will enter the OCP state.

Possible Cause

Many reasons can cause OCP, the details are as follows:

- The set protection limit **Level** is lower than the current Meter value.
- The external (AC input) inputs a higher current.
- The power supply outputs a high current due to a fault.

How to Set

The operation steps to set OCP are as follows.

1. Press the composite keys **[Shift]+[Recall]** (Protect) on the front panel to enter the protection menu.
2. Press the up/down key or rotate the knob to select **2. OCP (Off)** and press **[Enter]**.
3. Press the left/right key or rotate the knob to select **On** and press **[Enter]** to enter the setting interface.

4. Set the protection limit **Level** and the delay time **Delay** in sequence, and press **[Enter]** to confirm.

Note

For bi-directional power supplies, **Level** can be set to a positive or negative value, i.e. the same protection limit is set for the output or input current.

The VFD screen returns to the Protect menu and the OCP setting (take 10A, 1S as an example) is displayed as follows:

```
PROTECT
2.OCP  10A, 1.000S
```

4.5.3 Set Over-Power Protection (OPP)

Users can enable the OPP function and set the protection limit **Level** and protection delay time **Delay**. When the power (i.e., the Meter value) is greater than this protection limit and the delay time is exceeded, the power supply will enter the OPP state.

Possible Cause

Many reasons can cause OPP, the details are as follows:

- The set protection limit **Level** is lower than the power Meter value.
- The power supply outputs a high power due to a fault.

How to Set

The operation steps to set OPP are as follows.

1. Press the composite keys **[Shift]+[Recall]** (Protect) on the front panel to enter the protection menu.
2. Press the up/down key or rotate the knob to select **3. OPP (Off)** and press **[Enter]**.
3. Press the left/right key or rotate the knob to select **On** and press **[Enter]** to enter the setting interface.
4. Set the protection limit **Level** and the delay time **Delay** in sequence, and press **[Enter]** to confirm.

Note

For bi-directional power supplies, **Level** can be set to a positive or negative value, i.e. the same protection limit is set for the output or input power.

The VFD screen returns to the Protect menu and the OPP setting (take 150W, 1S as an example) is displayed as follows:

```
PROTECT
3.OPP 150W, 1.000S
```

4.5.4 Set Under-Current Protection (UCP)

Users can enable the UCP function and set the instrument warm-up time **Warm-up**, protection limit **Level** and protection delay time **Delay**. When the current (i.e., the Meter value) is lower than this protection limit and the warm-up time, delay time are exceeded, the power supply will enter the UCP state.

Possible Cause

Many reasons can cause UCP, the details are as follows:

- The set protection limit **Level** is greater than the current Meter value.
- The external (AC input) inputs a lower current.
- The power supply outputs a low current due to a fault.

How to Set

The operation steps to set UCP are as follows.

1. Press the composite keys **[Shift]+[Recall]** (Protect) on the front panel to enter the protection menu.
2. Press the up/down key or rotate the knob to select **4. UCP (Off)** and press **[Enter]**.
3. Press the left/right key or rotate the knob to select **On** and press **[Enter]** to enter the setting interface.
4. Set the warm-up time **Warm-up**, protection limit **Level** and delay time **Delay** in sequence, and then press **[Enter]** to confirm.

Note

For bi-directional power supplies, **Level** can be set to a positive or negative value, i.e. the same protection limit is set for the output or input current.

The VFD screen returns to the Protect menu and the UCP setting (take 10S, 0.1A, 1S as an example) is displayed as follows:

```
PROTECT
4.UCP  10S,  0.1A, 1.000S
```

4.5.5 Set Under-Voltage Protection (UVP)

Users can enable the UVP function and set the instrument warm-up time **Warm-up**, protection limit **Level** and protection delay time **Delay**. When the voltage (i.e., the Meter value) is lower than this protection limit and the warm-up time, delay time are exceeded, the power supply will enter the UVP state.

Possible Cause

Many reasons can cause UVP, the details are as follows:

- The set protection limit **Level** is greater than the voltage Meter value.
- The external (AC input) inputs a lower voltage.
- The power supply outputs a low voltage due to a fault.

How to Set

The operation steps to set UVP are as follows.

1. Press the composite keys **[Shift]+[Recall]** (Protect) on the front panel to enter the protection menu.
2. Press the up/down key or rotate the knob to select **5. UVP (Off)** and press **[Enter]**.
3. Press the left/right key or rotate the knob to select **On** and press **[Enter]** to enter the setting interface.
4. Set the warm-up time **Warm-up**, protection limit **Level** and delay time **Delay** in sequence, and then press **[Enter]** to confirm.

The VFD screen returns to the Protect menu and the UVP setting (take 10S, 1V, 1S as an example) is displayed as follows:

```
PROTECT
5.UVP  10S,  1V, 1.000S
```

4.5.6 Over-Temperature Protection (OTP)

When internal temperature of instrument is higher than about 90 °C, the instrument is under temperature protection. At this time, the instrument will

automatically be **OFF** and VFD status indicator **Prot** lights up and the screen prompts **OTP**.

Possible Cause

To prevent damaging heat build-up and ensure specified performance, make sure there is adequate ventilation and air flow around the instrument to ensure proper cooling. Do not cover the ventilation holes on the rear panel, sides, or bottom of the instrument. Even with proper ventilation, the instrument can over-heat in the following situations.

- If the ambient temperature is too high.
- If you use the instrument to test for long periods.

How to Set

The OTP limit does not need to be set, and the internal device of the instrument automatically detects and determines whether to enter the OTP state.

If an over-temperature condition occurs, power off the instrument and allow it to cool for at least 30 minutes. After the internal temperature of the instrument has cooled down, power it on again.

CAUTION

When you return power to the instrument, verify that the cooling fan is running. If not, please contact ITECH Technical Support. Leaving the instrument powered on with an inoperative cooling fan may result in damage to the instrument.

4.5.7 Sense Reverse Protection

The instrument defaults to provide sense reverse protection. The premise is that the Sense switch is turned on. When the output state is ON and the difference between output terminal voltage and sense remote voltage exceeds the specified voltage, sense reverse protection will be enabled after 500ms. The instrument output will be immediately switched to Off and the display screen will display **SENSE ERR** if the sense terminals are reversed.

When the instrument is in Sense Reverse Protection state, you should check whether the polarities are connected reversely or not firstly. If yes, you can re-open the output after the polarities connect correctly.

The voltage difference between output terminal and remote sense terminal of each model is not the same. When the remote sense terminal is connected reversely, the maximum voltage will not exceed the sum of output terminal voltage and the difference voltage.

Note

When Sense is reversed or short-circuited, the voltage meter value is displayed as a positive/negative value close to 0, and abnormal high voltage output does not occur, which can avoid damage to the DUT.

4.6 Function Menu for Power Supply

The Function menu of the power supply includes the following:

Function	Function Menu for Power Supply	
	LIST	LIST program editing, file import/export, program running (see 4.6.1 LIST Function).
	BATTERY	Battery charging and discharging testing function (see 4.6.2 Battery Charging/Discharging Test Function).
	Road-Vehicles	Built-in waveform function (see 4.6.3 Built-in Waveform Function).
	SAS	PV simulation function (see 4.6.4 Solar Photovoltaic Curve Simulation Function (SAS)).
	Battery Emulator	Battery simulation test function (see 4.6.5 Battery Simulation Function).

4.6.1 LIST Function

The IT6000C series power supply supports a total of 10 List files (List01 to List10), each of which can be set up to 200 steps. You need to edit the voltage/current value, slope and time width of each step, or you can set repeat times (0 to 65535) for each List file. After the file is edited completely, you can trigger the selected List file to run according to the selected trigger mode.

The descriptions of list function menu are listed in the table below.

LIST	List menu		
	Run	Indicates to enter the List run mode, waiting for the trigger to run the currently selected List file.	
	Open	Select the List file to open.	
	USB	Open the List file in the external USB flash disk.	
		Load	Import the List file from the external USB flash disk into the instrument.
		Not-Load	Cancel the import operation.
	Internal	Open the List file stored inside the instrument.	
		Recall Inner List Group	Set the name of the recalled List file.
	Export	Export the internal List file of the instrument to an external USB flash drive.	
		Yes/No	Whether to export List files.
	Edit	Edit list program.	
		CC / CV	Set the operation mode for list program: CC priority or CV priority.
		Step Count	The total number of steps included in the List program.
		Step 1 Value	Current value or voltage value setting for Step1. (The voltage appears when CV priority is selected; the current appears when CC priority is selected.)
		Step 1 Slope	Slope value setting for Step1.
		Step 1 Width	Dwell time setting for Step1. The range is from 0.001 to 864000 in seconds.
		Time / Repeat	Time indicates the total running time of the List, and Time is displayed by default as the total time of a loop execution. Setting range: 0.00~100 million, where setting to 0 means infinite loop. Unit: second.

			<p>Set the number of list file repetitions. Setting range: 0~65535, where setting to 0 means infinite loop.</p> <p>Note: The settings of Time and Repeat parameters affect each other, and the last setting takes effect. For example, if a loop is 10s, first set Time to 40s, then set Repeat=5, the total running time of List is 50s; if a loop is 10s, first set Repeat=5, then set Time to 100s, the total running time of List is 100s; if a loop is 10s, first set Repeat=5, then set Time to 105s, the system does the rounding calculation, the total time of List running is 100s.</p>
	End State		Set the running state after the list program is running over.
		Last	After the List program finishes running, the output is kept as the setting in the last step, and the working mode remains as the setting in the List file.
		Normal	After the List program finishes running, the working mode and voltage/current output return to the settings before the List running.
		OFF	The output is closed after the execution of the List is finished.
	Trig Out		Function switch that triggers the signal output. It is applicable to the scenario of synchronously controlling multiple units, that is, by connecting the outer loop interfaces TX and RX of the fiber to realize List synchronization triggering between multiple units.
		None	Turn off (default)
		Tout	Turn on
	Save to group		Save the edited List program.

Edit List Program

The following takes CC priority mode as an example to introduce the operation of editing two test steps.

1. Press the composite keys **[Shift]+[I-set]** (Function) on the front panel to enter the function menu.
2. Select **1. LIST: Off** and press **[Enter]**.
3. Press the Left/Right key to select **Edit** and press **[Enter]** to enter the editing interface.
4. Select **CC** and press **[Enter]** to confirm.
5. Set the total number of steps in the List program and press **[Enter]** to confirm.
6. Set the current, slope and time width of step 1 in turn, and press **[Enter]** to confirm.
7. Set the parameters of step 2 in the same method.
8. Set the number of list repetitions **Repeat**, and press **[Enter]** to confirm.
9. Set the **End State** as **Normal**, and press **[Enter]** to confirm.
10. Depending on the test requirement, choose whether to turn on the function switch that triggers synchronization.
11. Set the currently edited List program name.

If you choose not to save, press **[Esc]** to exit the editing interface.

Import List Program

If you need to run the List program on the external USB flash drive, you need to import the List program from the USB flash drive into the instrument.



Note

The format of the List file in the USB flash drive must be in **.csv** format and saved in the root directory of the USB flash drive. You can refer to [Export List Program](#) to customize editing according to the List file template exported to the USB flash drive.

The procedures are as follows:

1. Insert the USB flash drive into the front panel USB connector.
2. Press the composite keys **[Shift]+[I-set]** (Function) on the front panel to enter the function menu.
3. Select **1. LIST: Off** and press **[Enter]**.

4. Press the Left/Right key to select **Open** and press **[Enter]**.
5. Select **USB** and press **[Enter]**.

At this point, the system will automatically read all the List files in the root directory of the USB flash drive. The interface is displayed as follows:

```
XXX.csv
Not-Load Load YY/ZZ
```

XXX indicates the name of the List file; YY indicates the serial number of the current List file; ZZ indicates the total number of the List file.

6. Press the Up/Down key to select the List file.
7. Press the Left/Right key to select **Load**, press **[Enter]** to complete the import, and wait for the trigger to run this List file.

At this point, the interface returns to the main interface of the system and **WTG** is displayed in the lower right corner.

Select Internal List Program

You can select a List file saved inside the instrument to be in the **Open** state and wait for subsequent triggers to run. The procedures are as follows:

1. Press the composite keys **[Shift]+[I-set]** (Function) on the front panel to enter the function menu.
2. Select **1. LIST: Off** and press **[Enter]**.
3. Press the Left/Right key to select **Open** and press **[Enter]**.
4. Press the Left/Right key to select **Internal** and press **[Enter]**.
5. Set the name of the List file to be recalled (that is, the file name set in **Edit**), and press **[Enter]**.

The interface returns to the main interface of the LIST function, which is displayed as follows:

```
FUNCTION LIST
Run Open Edit Export
```

If you select **Run** and press **[Enter]**, the instrument will enter LIST mode and wait for the trigger to run.

Export List Program

Supports exporting the internal List file to an external USB flash drive. The exported List file is saved in **.csv** format.

1. Insert the USB flash drive into the front panel USB connector.

2. Press the composite keys **[Shift]+[I-set]** (Function) on the front panel to enter the function menu.
3. Select **1. LIST: Off** and press **[Enter]**.
4. Press the Left/Right key to select **Open** and press **[Enter]**.
5. Press the Left/Right key to select **Internal** and press **[Enter]**.
6. Set the name of the List file to be recalled (that is, the file name set in **Edit**), and press **[Enter]**.

The interface returns to the main interface of the LIST function, which is displayed as follows:

```
FUNCTION   LIST
Run Open Edit Export
```

7. Press the Left/Right key to select **Export** and press **[Enter]**.
8. Press the Left/Right key to select **Yes** and press **[Enter]**.

Indicates that the selected List file in **Open** is exported to the USB flash drive.

Run the List Program

You can select a List file to execute according to your needs, so that the power supply outputs the corresponding waveform sequence. Take the List file in **Internal** as an example. The steps are as follows:

1. Press the composite keys **[Shift]+[I-set]** (Function) on the front panel to enter the function menu.
2. Select **1. LIST: Off** and press **[Enter]**.
3. Press the Left/Right key to select **Open** and press **[Enter]**.
4. Press the Left/Right key to select **Internal** and press **[Enter]**.
5. Set the name of the List file to be recalled (that is, the file name set in **Edit**), and press **[Enter]**.

The interface returns to the main interface of the LIST function, which is displayed as follows:

```
FUNCTION   LIST
Run Open Edit Export
```

6. Press the Left/Right key to select **Run** and press **[Enter]**.

At this point, the interface returns to the main interface of the system and **WTG** is displayed in the lower right corner.

7. Turn on the **[On/Off]**.
8. Based on the selected trigger method, perform the trigger operation.

Take the manual trigger as an example. Press **[Shift]+[On/Off]**(Trigger) on the front panel to run the selected List file. For details about the List trigger method, see [5.8 Select Trigger Source \(Trig Source\)](#).



- The system will adjust the working mode of the power supply according to the CC or CV priority mode set in the List file. For example, if the current power supply is in the CV priority mode, and the list file to be run is set to the CC priority mode, then the power supply will work in the CC priority mode after the List file is triggered to run.
- After the List file finishes running, the system determines whether to return to the working mode before the List is run according to the **Normal** or **Last** option you selected.

Stop Running the List Program

When the List program is running, if you need to stop running, you can do the following: Press the composite keys **[Shift]+[I-set]** (Function) on the front panel to enter the function menu.

At this point, the interface will prompt whether to stop the running of the Function, you can press the Left/Right key to select **Stop**, then the running will be stopped, and the Function menu item will be displayed, you can re-enter the Function menu for editing; if **Reset** is selected, it means to stop the present running and return to the main interface to wait for the next trigger operation; if **Pause** is selected, it means that the present running is suspended, and you can continue to run by selecting **Resume**.

4.6.1.1 ARB Function

This series of instruments comes standard with ARB (arbitrary waveform) function, which allows the output of user-defined arbitrary complex voltage or current waveforms. It can be operated in the following ways:

- **Import via U disk**

The instrument supports importing the edited **.csv** format file (the template can be obtained by contacting ITECH personnel) through the USB interface on the front panel, and generating voltage or current values after parsing, and then outputting complex voltage or current waveforms according to the time width specified by the user. The user can edit a **.csv** file containing up to 10 million voltage or current points and import it into the instrument for running to realize arbitrary waveform output or working condition simulation. The instrument has the ability to quickly parse data. A **.csv** file of dozens of megabytes can be imported and parsed within 5S, making testing more convenient and efficient.

This instrument supports importing the **.csv** files corresponding to the following waveforms:

- CDWELL: Constant dwell arbitrary waveform

The fields included in the .csv template file are explained as follows:

Model	Device model, keep the default settings without modification.
Firmware Version	Firmware version number, keep the default settings without modification.
Serial Number	Device serial number, keep the default settings without modification.
File Type	File type, keep the default settings without modification.
Waveform Type	Waveform type, keep the default settings without modification.
Value Unit	The CV priority is set to V, and the CC priority is set to A.
Offset Unit	Offset value unit, CV priority is set to V, CC priority is set to A.
Time Unit	Time unit, fixed to S.
Mode	Indicates the power supply working mode. The CV priority is set to CV, and the CC priority is set to CC.
Repeat	Repeat times, the setting range is 1~65535.
End State	Indicates the end state. Last (voltage or current maintained at the last point after completion) or Normal (return to the mode before CDWELL execution after completion).
Total Point	The total number of waveform points.
Keep Time	Indicates the pulse width of each point. Range: 0~3600. Unit: seconds.
Value	Voltage or current value at each point.

- List: User-defined waveform

The fields included in the .csv template file are explained as follows:

Model	Device model, keep the default settings without modification.
Firmware Version	Firmware version number, keep the default settings without modification.

Serial Number	Device serial number, keep the default settings without modification.
File Type	File type, keep the default settings without modification.
Waveform Type	Waveform type, keep the default settings without modification.
Vaule Unit	The CV priority is set to V, and the CC priority is set to A.
Slope Unit	Slope unit, fixed to S.
Time Unit	Time unit, fixed to S.
Mode	Indicates the power supply working mode. The CV priority is set to CV, and the CC priority is set to CC.
Step Count	The total number of steps, up to 10 million points can be edited.
Repeat	Repeat times, the setting range is 1~65535.
End State	Indicates the end state. Last (the voltage or current maintained at the last step after the end) or Normal (return to the normal mode before the List is executed after the end).
Step Index	The sequence number of the single step.
value	Voltage or current value for a single step.
slope	Slope for a single step.
Keep Time	Pulse width for a single step.

- Sine: Sine wave

The fields included in the .csv template file are explained as follows:

Model	Device model, keep the default settings without modification.
Firmware Version	Firmware version number, keep the default settings without modification.
Serial Number	Device serial number, keep the default settings without modification.
File Type	File type, keep the default settings without modification.

Waveform Type	Waveform type, keep the default settings without modification.
Amp Unit	Peak-to-peak unit, CV priority is set to V, CC priority is set to A.
Offset Unit	Offset value unit, CV priority is set to V, CC priority is set to A.
Frequency Unit	Frequency unit, Hz.
Mode	Indicates the power supply working mode. The CV priority is set to CV, and the CC priority is set to CC.
Repeat	Repeat times, the setting range is 1~65535.
Amp	Peak-to-peak
Offset	Offset value
Frequency	Frequency value, the default maximum is 250Hz.
End State	Indicates the end state. Last (the voltage or current maintained at the last step after the end) or Normal (returns to the normal mode before Sine is executed).

- Sweep: Sweep wave

The fields included in the .csv template file are explained as follows:

Model	Device model, keep the default settings without modification.
Firmware Version	Firmware version number, keep the default settings without modification.
Serial Number	Device serial number, keep the default settings without modification.
File Type	File type, keep the default settings without modification.
Waveform Type	Waveform type, keep the default settings without modification.
Amp Unit	Peak-to-peak unit, CV priority is set to V, CC priority is set to A.
Offset Unit	Offset value unit, CV priority is set to V, CC priority is set to A.
Time Unit	Time unit, S.

Frequency Unit	Frequency unit, Hz.
Mode	Indicates the power supply working mode. The CV priority is set to CV, and the CC priority is set to CC.
Repeat	Repeat times, the setting range is 1~65535.
Amp	Peak-to-peak
Offset	Offset value
Start Frequency	Start frequency
End Frequency	Stop frequency
Step DwellH	Total running time
Step time	Single-step pulse width. Single-step pulse width and single-step repetition times can be set by selecting one of them.
Step Repeat	The number of repetitions of a single step. Single-step pulse width and single-step repetition times can be set by selecting one of them.
Step mode	Operation mode, can be set to 0 or 1. When set to 0, it means that the total running time Step DwellH and the single-step pulse width Step time are used as the running end condition; when set to 1, it means that the single-step repetition times Step Repeat is used as the running end condition.
End State	Indicates the end state. Last (the voltage or current maintained at the last step after the end) or Normal (return to the normal mode before the Sweep is executed).

The steps are as follows:

1. Edit the **.csv** file corresponding to the template on the PC and save it.
2. Save the edited file in the root directory of the U disk.
3. Insert the U disk into the front panel of the instrument.
4. Press the composite keys **[Shift]+[I-set]** (Function) on the front panel to enter the function menu.
5. Select the **1. LIST: Off** and press **[Enter]**.
6. Press left/right key to select **Open** and press **[Enter]**.

7. Select the **USB** and press **[Enter]**.

At this point, the system will automatically read all the List files in the root directory of the USB flash drive. The interface is displayed as follows:

```
XXX.csv
```

```
Not-Load Load YY/ZZ
```

XXX indicates the name of the List file; YY indicates the serial number of the current List file; ZZ indicates the total number of the List file.

8. Press the Up/Down key to select the file.
9. Press the Left/Right key to select **Load**, press **[Enter]** to complete the import, and wait for the trigger to run this file.
10. Turn on the **[On/Off]**.
11. Based on the selected trigger method, perform the trigger operation.

- **Programming via SCPI instructions**

For detailed instructions and parameter introduction, please refer to the instructions of "ARB Subsystem" in the Programming Guide.

- **Realized by the software IT9000 on PC**

For detailed function usage, please refer to IT9000–PV6000 User Manual.

4.6.2 Battery Charging/Discharging Test Function

The IT6000C series power supply provides the battery charging/discharging test function based on its unique bidirectional power supply properties. Suitable for charging/discharging tests on all types of portable batteries.

WARNING

- **When connecting the DUT (battery/capacitor), do not short-circuit the battery/capacitor.**
- **It is recommended that for battery testing, a fuse must be connected in series between the power supply and the battery to prevent short circuits caused by any problems.**
- **When connecting the DUT (including but not limited to battery/capacitor), it is recommended that you purchase the IT-E165A anti-reverse connection and anti-spark module to prevent the battery/capacitor reverse connection that may cause damage to the instrument and spark during the battery/capacitor wiring; When there is no external auxiliary equipment connected to prevent reverse connection and anti-spark function, please pay attention to the safety of the wiring, and be careful not to reverse the battery/capacitor connection, reverse connection will cause damage to the instrument, even if it is not powered on.**
- **Before performing the battery test, you need to connect the Sense cables to both ends of the battery. If the Sense cables are not connected, the instrument cannot detect the Sense voltage and prompt “Wait Power Link”, which will prevent the battery test from continuing.**

BATTERY	Battery charging/discharging test function		
	Run	Indicates that the battery test mode is entered and waits to trigger the running of the currently edited battery test file.	
	Edit	Edit the battery charging/discharging test file.	
	Charge / Discharge	Set the test mode: <ul style="list-style-type: none"> • Charge: Battery charging • Discharge: Battery discharging According to the test requirements, choose one to set.	
		Charge / Discharge V	Set the voltage value for charging or discharging

				according to the selected test mode.
			Charge / Discharge I	Set the current value for charging or discharging according to the selected test mode.
			Charge / Discharge Time	Set the charging or discharging time according to the selected test mode.
		Cut Off Voltage		Battery test cut-off voltage
		Cut Off Current		Battery test cut-off current
		Cut Off Capacity		Battery test cut-off capacity

Note

This instrument supports battery discharge test in constant current and constant power modes. If the user wants to discharge in constant current mode, enter the **Config** menu, select the **CC** priority, set **VI** to 0, set **Vh** to the rated voltage value of the instrument, set **P-** to the rated power value of the instrument, and then set the Battery menu according to the test requirements. If the user wants to discharge in constant power mode, set **P-** to the specified value, and set **Discharge V** and **Discharge I** to the rated voltage and current value of the instrument.

1. Press the composite keys **[Shift]+[I-set]** (Function) on the front panel to enter the function menu.
2. Use knob or Up/Down key to select **2.BATTERY: Off** and press **[Enter]**.

The interface is displayed as follows:

```
FUNCTION BATTERY
Run Edit
```

3. Press the Left/Right key to select **Edit** and press **[Enter]**.
4. Press the Left/Right key to select **Charge** or **Discharge** and press **[Enter]**.
5. Set the charging voltage (**Charge V**) or discharging voltage (**Discharge V**), charging current (**Charge I**) or discharging current (**Discharge I**) and the other parameters, and then press **[Enter]** to confirm.

After the parameter setting is completed, the interface returns to the Battery function main interface and displays as follows:

```
FUNCTION BATTERY
Run Edit
```

6. Press the Left/Right key to select **Run** and press **[Enter]**.

The instrument will enter the battery test mode and wait for the battery test to be triggered.

7. Turn on the **[On/Off]**.



Note

This product supports Sense anti-reverse function. If you reverse the Sense cables, the VFD will display a negative voltage value, and you cannot turn on the output at this time. It can only be turned on after the cables are properly connected.

8. Based on the selected trigger method, perform the trigger operation.



Note

The trigger method of the battery test is consistent with the trigger method of the List function, that is, the List trigger source is also effective for the Battery function.

If you want to stop running during the battery test, you can do the following: Press the composite keys **[Shift]+[I-set]** (Function) on the front panel to enter the function menu.

At this point, the interface will prompt whether to stop the running of the Function, you can press the Left/Right key to select **Stop**, then the running will be stopped, and the Function menu item will be displayed, you can re-enter the Function menu for editing; if **Reset** is selected, it means to stop the present running and return to the main interface to wait for the next trigger operation.

4.6.3 Built-in Waveform Function

The IT6000C series power supply supports built-in waveforms for user to execute the test directly. The protocols/standards involved in the built-in waveforms include the following:

- DIN40839
- ISO16750-2

- ISO21848
- SAEJ1113–11
- LV123
- LV124
- LV148
- ISO21780

The following is a general overview of this function menu, and the detailed parameters of the waveform corresponding to each protocol/standard can be found in the corresponding chapter.

WARNING

- **If there is a waveform parameter related to setting the voltage value, when the upper limit of the voltage setting defined in the regulation exceeds the rated voltage of the instrument, the rated voltage of the instrument is set as the upper limit. Otherwise, the output waveform may be distorted.**
- **Some voltage level models may not have certain automotive waveforms. For example, 80V voltage level models do not support LV123 high-voltage automotive waveforms.**

Road-Vehicles	Vehicle waveform function menu	
	DIN40839	Evaluation of automotive starting waveform
	ISO16750-2	Simulate the waveform to verify the anti-interference performance of the automotive electronics' products.
	ISO21848	42V Road vehicles — Electrical and electronic equipment for a supply voltage of 42 V — Electrical loads
	SAEJ1113-11	SAEJ1113-11 Waveform protocol
	LV123	LV123 Waveform protocol
	LV124	LV124 Waveform protocol
	LV148	LV148 Waveform protocol
	ISO21780	ISO21780 Waveform protocol

Recall the Vehicle Waveform

Select any of the above five kinds of vehicle waveforms, after completing the waveform parameter setting (see the subsequent introduction for each parameter), the system will automatically enter the waveform recalling mode and wait for the triggering operation. At this time, the VFD screen is displayed as the main interface of the system, and the corresponding waveform name is displayed in the lower right corner.

Run the Vehicle Waveform

After turning on **[On/Off]**, the output of the vehicle waveform is triggered according to the selected trigger method.



Note

The trigger method of the vehicle waveform is consistent with the trigger method of the List function, that is, the List trigger source is also effective for the vehicle waveform.

Stop the Vehicle Waveform Running

If you want to stop during the vehicle waveform output, you can do the following: Press the composite keys **[Shift]+[I-set]** (Function) on the front panel to enter the function menu.

At this point, the interface will prompt whether to stop the running of the Function, you can press the Left/Right key to select **Stop**, then the running will be stopped, and the Function menu item will be displayed, you can re-enter the Function menu for editing; if **Reset** is selected, it means to stop the present running and return to the main interface to wait for the next trigger operation; if **Pause** is selected, it means that the present running is suspended, and you can continue to run by selecting **Resume**.

4.6.3.1 Automotive Starting Waveform

The IT6000C series power supply has built-in 12V or 24V DIN40839 waveform. This test verifies the behavior of a DUT during and after cranking. This waveform can reproduce the voltage curve for automotive power network confirms to DIN40839 standard, thus facilitating quick call by customers.

For automotive startup voltage waveform, the startup voltage can also be set based on customers' requirements. In this way, the user can create waveform between 8V to 32V.

DIN40839	Evaluation of automotive starting waveform		
	12V	Select the automotive starting waveform with a starting voltage of 12V.	
	24V	Select the automotive starting waveform with a starting voltage of 24V.	
	User-defined	The user customizes the starting voltage of the automotive starting waveform.	
		V=8.00V	User-defined voltage value

DIN40839 for 12V System

Steps	Voltage (V)	Current(A)	Width(mS)	Slope(mS)
1	4.5	60	15	5
2	6	60	2000	5
3	12	60	T	10

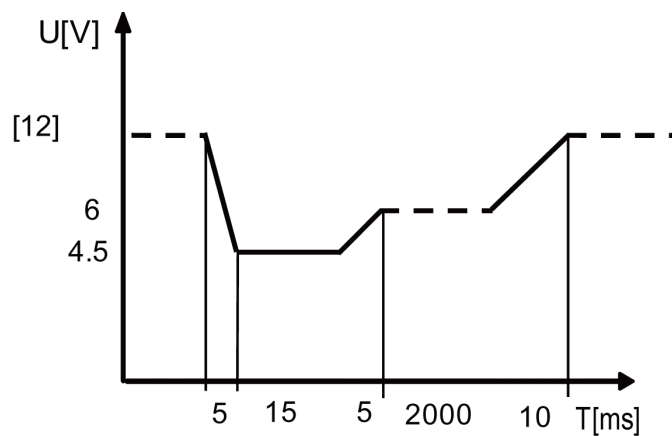

DIN40839 for 24V System

Steps	Voltage (V)	Current(A)	Width(mS)	Slope(mS)
1	8V	60	50	10
2	12V	60	2000	5
3	24V	60	T	10

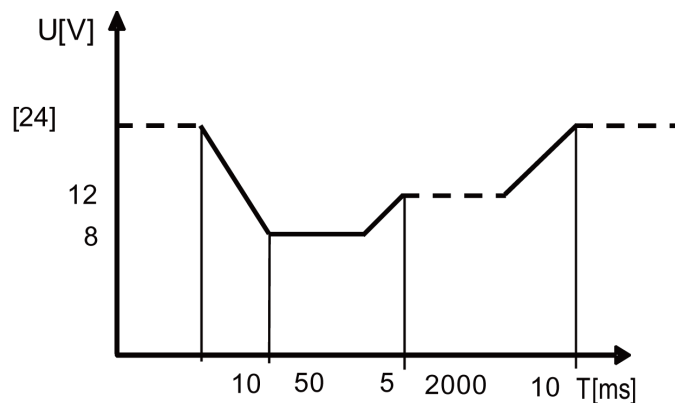
User-defined Startup Voltage Waveform System

The user can define the startup voltage, ranging from 8V to 32V. When the waveform program is divided into 8V-16V, the waveform is consistent with standard 12V; when the waveform program is divided into 16V-32V, the waveform is consistent with the standard 24V waveform. The waveform diagram is shown below.

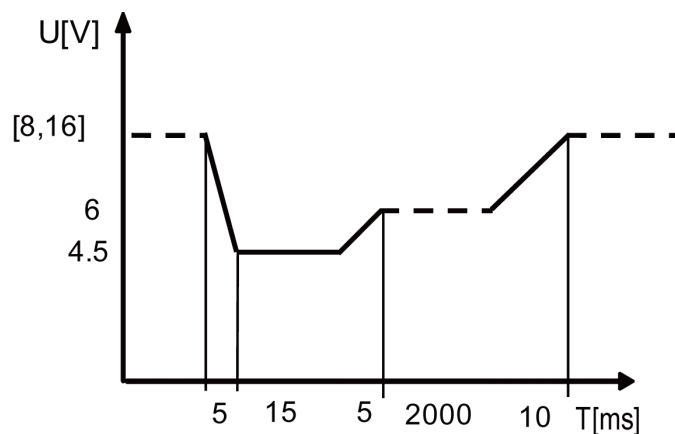

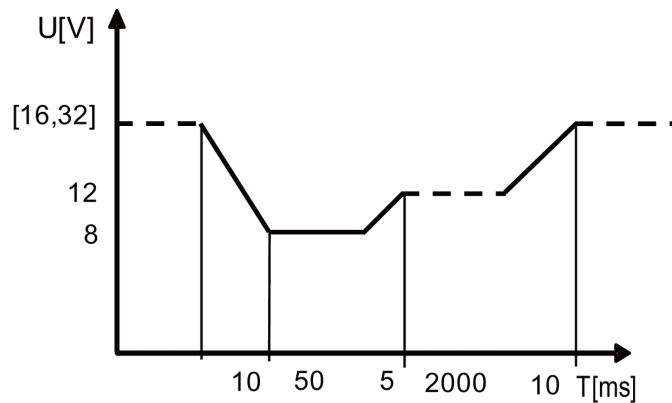

How to Use

Recall the self-defined DIN waveform operation (taking 12.5V voltage waveform as an example):

1. Press the composite keys **[Shift]+[I-set]** (Function) on the front panel to enter the function menu.
2. Use the knob or press the Up/Down key to select **3.Road-Vehicles = Off** and press **[Enter]**.
3. Press the Left/Right key to select **DIN40839** and press **[Enter]**.
4. Press the Left/Right key to select **User-defined** and press **[Enter]**.
5. Set the startup voltage as **V=12.5V** and press **[Enter]**.

The interface returns to the main interface of the system and displays **DIN40839**.

6. Press **[On/Off]** on the front panel to turn on the output.
7. According to the selected trigger method (same as the trigger method of the LIST function), for example, press **[Shift]+[On/Off]**(Trigger) to trigger the output of the waveform.

4.6.3.2 Simulate the Waveform to Verify the Anti-interference Performance of the Automotive Electronics' Products

To verify the anti-interference performance of the automotive electronics' products. Output pulse waveform completely meets the International Standard ISO-16750-2, convenient for quick recall by the user.

ISO16750-2	Simulate the waveform to verify the anti-interference performance of the automotive electronics' products.	
	Short-Drop	Automotive short-time voltage drop waveform

		12V	Select the 12V automotive short-time voltage drop waveform
		24V	Select the 24V automotive short-time voltage drop waveform
Reset-Test	This test is applicable to equipment with reset function.		
		Usmin	The minimum supply voltage Usmin (Usmin≤80V)
Starting-Profile	This test verifies the behavior of a DUT during and after cranking.		
		12V	Select the 12V test system.
		1	Select the voltage/duration of 12V starting profile corresponding to Level 1.
		2	Select the voltage/duration of 12V starting profile corresponding to Level 2.
		3	Select the voltage/duration of 12V starting profile corresponding to Level 3.
		4	Select the voltage/duration of 12V starting profile corresponding to Level 4.
		24V	Select the 24V test system.
		1	Select the voltage/duration of 24V starting profile corresponding to Level 1.
		2	Select the voltage/duration of 24V starting profile corresponding to Level 2.
		3	Select the voltage/duration of 24V starting profile corresponding to Level 3.
Load-Dump	Load dump curve		

		Test A	Select centralized load dump unsuppression	
		12V	Select the 12V voltage system	
			Td	Pulse width
			Un	Peak voltage
		24V	Select the 24V voltage system	
			Td	Pulse width
			Un	Peak voltage
		Test B	Select centralized load dump suppression	
		12V	Select the 12V voltage system	
			Td	Pulse width
			Un	Peak voltage
		24V	Select the 24V voltage system	
Td	Pulse width			
Un	Peak voltage			
	Us	Supply voltage And the clamping voltage U_s^* is calculated as follows: $U_s^* = (U_s - 4.28) \times U_n \div 80$		

Automotive Short-time Voltage Drop Waveform

This waveform simulates an instantaneous drop in the supply voltage when the car is started. This test simulates the effect when a conventional fuse element melts in another circuit.

- 12V system

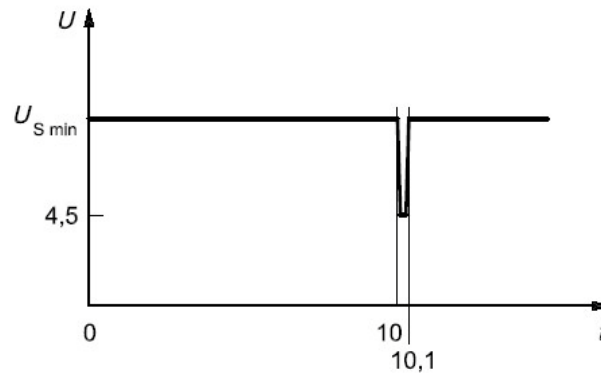

- 24V system

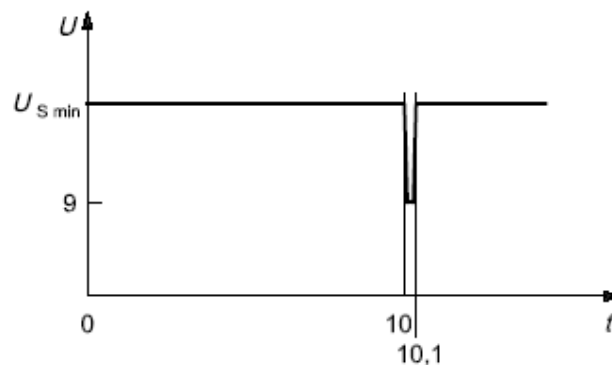

How to recall this waveform from menu (take 12V system as an example):

1. Press the composite keys **[Shift]+[I-set]** (Function) on the front panel to enter the function menu.
2. Use the knob or press the Up/Down key to select **3.Road-Vehicles = Off** and press **[Enter]**.
3. Press the Left/Right key to select **ISO16750-2** and press **[Enter]** to confirm.
4. Press the Left/Right key to select **Short-Drop** and press **[Enter]** to confirm.
5. Press the Left/Right key to select **12V** and press **[Enter]** to confirm.

The interface returns to the main interface of the system and displays **SHORT-DROP**.

6. Press **[On/Off]** on the front panel to turn on the output.
7. According to the selected trigger method (same as the trigger method of the LIST function), for example, press **[Shift]+[On/Off]**(Trigger) to trigger the output of the waveform.

Reset-Test

This test verifies the reset behavior of the DUT at different voltage drops. This test is applicable to equipment with reset function, e.g. equipment containing

microcontroller. Apply the test pulse simultaneously in figure below to all relevant inputs (connections) and check the reset behavior of the DUT. Decrease the supply voltage by 5 % from the minimum supply voltage, $U_{s \text{ min}}$, to $0.95 U_{s \text{ min}}$. Hold this voltage for 5 s. Raise the voltage to $U_{s \text{ min}}$. Hold $U_{s \text{ min}}$ for at least 10 s and perform a functional test. Then decrease the voltage to $0.95 U_{s \text{ min}}$. Continue with steps of 5 % of $U_{s \text{ min}}$, as shown in figure below, until the lower value has reached 0 V. Then raise the voltage to $U_{s \text{ min}}$ again.

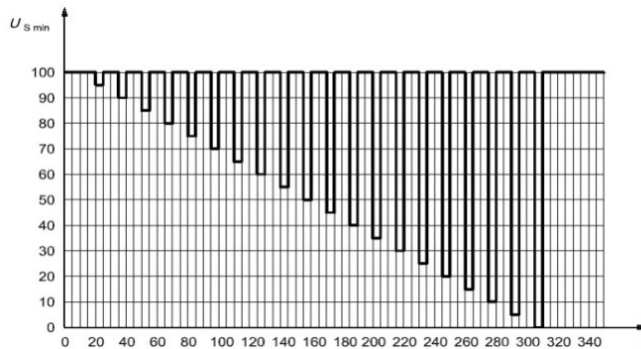

How to recall this waveform from menu is as below:

1. Press the composite keys **[Shift]+[I-set]** (Function) on the front panel to enter the function menu.
2. Use the knob or press the Up/Down key to select **3.Road-Vehicles = Off** and press **[Enter]**.
3. Press the Left/Right key to select **ISO16750-2** and press **[Enter]** to confirm.
4. Press the Left/Right key to select **Reset-Test**, and press **[Enter]** to confirm.
5. Press the numeric keys to set the **Usmin**, and press **[Enter]** to confirm.

The interface returns to the main interface of the system and displays **RESET-TEST**.

6. Press **[On/Off]** on the front panel to turn on the output.
7. According to the selected trigger method (same as the trigger method of the LIST function), for example, press **[Shift]+[On/Off]**(Trigger) to trigger the output of the waveform.

Starting Waveform

Simulates the effects of rippled DC voltage on DC power when the car is started. From the constant voltage line in the original standard DIN40839 voltage waveform, the voltage curve in t8 duration is upgraded to a curve containing a 2Hz AC voltage waveform.

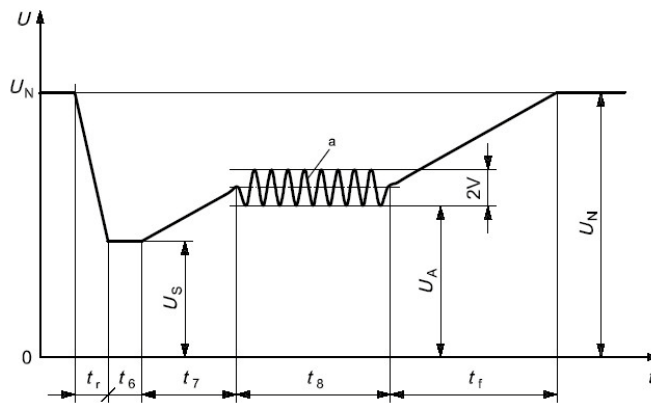

- Standards for 12V system:

Curve should be selected based on actual test requirements. To create waveform within 12V, follow the set standards as below:

Levels/voltages/duration of starting profile				
I	II	III	IV	Tolerances
$U_S = 8 \text{ V}$	$U_S = 4,5 \text{ V}$	$U_S = 3 \text{ V}$	$U_S = 6 \text{ V}$	+ 0,2 V
$U_A = 9,5 \text{ V}$	$U_A = 6,5 \text{ V}$	$U_A = 5 \text{ V}$	$U_A = 6,5 \text{ V}$	
$t_r = 5 \text{ ms}$				± 10 %
$t_6 = 15 \text{ ms}$				
$t_7 = 50 \text{ ms}$				
$t_8 = 1 \text{ s}$	$t_8 = 10 \text{ s}$	$t_8 = 1 \text{ s}$	$t_8 = 10 \text{ s}$	
$t_f = 40 \text{ ms}$	$t_f = 100 \text{ ms}$	$t_f = 100 \text{ ms}$	$t_f = 100 \text{ ms}$	



Note

I, II, III, and IV defined in the above standard correspond to levels 1, 2, 3, and 4 in the setup menu.

- Standards for 24V system:

Levels/voltages/duration of starting profile			
I	II	III	Tolerances
$U_S = 10 \text{ V}$	$U_S = 8 \text{ V}$	$U_S = 6 \text{ V}$	+ 0,2 V
$U_A = 20 \text{ V}$	$U_A = 15 \text{ V}$	$U_A = 10 \text{ V}$	
$t_r = 10 \text{ ms}$			± 10 %
$t_6 = 50 \text{ ms}$			
$t_7 = 50 \text{ ms}$			
$t_8 = 1 \text{ s}$	$t_8 = 10 \text{ s}$	$t_8 = 1 \text{ s}$	
$t_f = 40 \text{ ms}$	$t_f = 100 \text{ ms}$	$t_f = 40 \text{ ms}$	

How to recall this waveform from menu (take 12V system as an example):

1. Press the composite keys **[Shift]+[I-set]** (Function) on the front panel to enter the function menu.
2. Use the knob or press the Up/Down key to select **3.Road-Vehicles = Off** and press **[Enter]**.
3. Press the Left/Right key to select **ISO16750-2** and press **[Enter]** to confirm.
4. Press the Left/Right key to select **Starting-Profile**, and press **[Enter]** to confirm.
5. Press the Left/Right key to select **12V**, and press **[Enter]** to confirm.
6. Press the Left/Right key to select the Level (i.e. **4**), and press **[Enter]** to confirm.

The interface returns to the main interface of the system and displays **STARTING-PROFILE**.

7. Press **[On/Off]** on the front panel to turn on the output.
8. According to the selected trigger method (same as the trigger method of the LIST function), for example, press **[Shift]+[On/Off]**(Trigger) to trigger the output of the waveform.

Load Dump Dynamic Behavior

This test is a simulation of load dump transient occurring in the event of a discharged battery being disconnected while the alternator is generating charging current with other loads remaining on the alternator circuit at this moment.

- The amplitude of load dump is determined by the rotational speed of alternator and the strength of magnetic field in the case of disconnection of the battery.
- The pulse duration of load dump is mainly determined by the time constant and pulse amplitude of the excitation circuit.

Inside most novel alternator, the amplitude of load dump is decreased by increasing the limiter diode (clamping diode). The load dump may be caused by cable corrosion, poor cable contact or disconnecting the battery intentionally when the engine is running.

The pulse shape and parameters for an alternator without centralized load dump suppression (Test A) are given in follow.

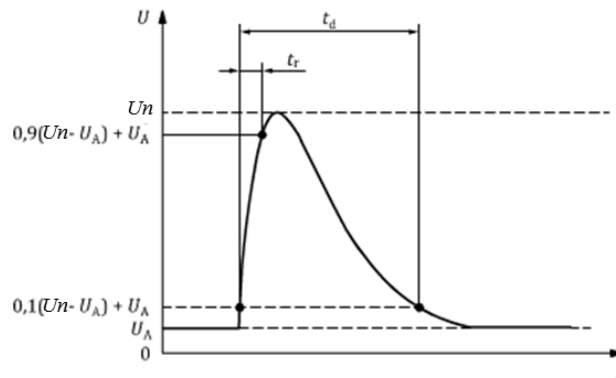

- t : Time
- U : Voltage
- t_d : Duration of pulse
- t_r : Rising Slope
- U_A : The supply voltage of the generator in operation: $U_A = 14V$ in the 12V system, $U_A = 28V$ in the 24V system. (see ISO 16750-1)
- U_n : Peak voltage

Parameter	Type of system		Minimum test requirements
	12V	24V	
$U_n^a(V)$	$79 \leq U_n \leq 101$	$151 \leq U_n \leq 202$	10 pulses at 1 min intervals
$R_i^a(\Omega)$	$0.5 \leq R_i \leq 4$	$1 \leq R_i \leq 8$	
$t_d(ms)$	$40 \leq t_d \leq 400$	$100 \leq t_d \leq 350$	
$t_r(ms)$	–	–	

 **Note**

^aIf not otherwise agreed, use the upper voltage level with the upper value for internal resistance or use the lower voltage level with the lower value for internal resistance.

The pulse shape and parameters for an alternator with centralized load dump suppression (Test B) are given in follow.

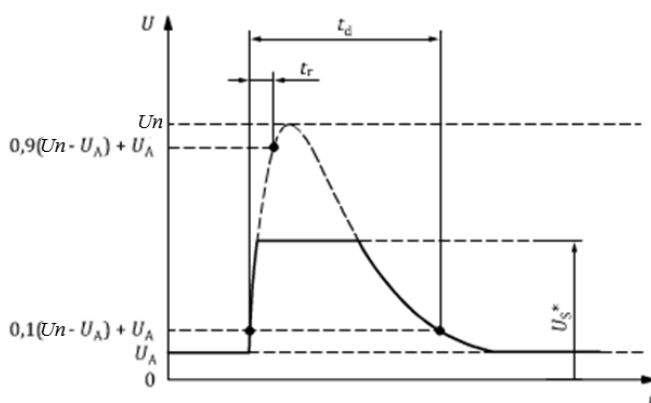

- t: Time
- U: Voltage
- t_d : Duration of pulse
- t_r : Rising Slope
- U_A : The supply voltage of the generator in operation: $U_A=14V$ in the 12V system, $U_A=28V$ in the 24V system. (see ISO 16750-1)
- U_n : Peak voltage
- U_S^* : Supply voltage with load dump suppression (i.e. clamping voltage)

$$U_S^* = (U_S - 4.28) \times U_n \div 80$$

U_S is the setting item in the menu.

Parameter	Type of system		Minimum test requirements
	12V	24V	
$U_n^a(V)$	$79 \leq U_n \leq 101$	$151 \leq U_n \leq 202$	5 pulses at 1 minute intervals
$U_S^*(V)$	It is fixed at 35V here and cannot be set.	Calculated according to the setting value U_S (typical value 58)	
$R_i^a(\Omega)$	$0.5 \leq R_i \leq 4$	$1 \leq R_i \leq 8$	
$t_d(ms)$	$40 \leq t_d \leq 400$	$100 \leq t_d \leq 350$	
$t_r(ms)$	–	–	



Note

^aIf not otherwise agreed, use the upper voltage level with the upper value for internal resistance or use the lower voltage level with the lower value for internal resistance.

The following general considerations of the dynamic behavior of alternators during load dump apply:

- The internal resistance of an alternator, in the case of load dump, is mainly a function of alternator rotational speed and excitation current.
- The internal resistance, R_i , of the load dump test pulse generator shall be obtained from the following relationship.

$$R_i = \frac{10 \times U_{\text{nom}} \times N_{\text{act}}}{0.8 \times I_{\text{rated}} \times 12000 \text{min}^{-1}}$$

- U_{nom} : The specified voltage of the alternator
- I_{rated} : The specified current at an alternator speed of 6000r/min
- N_{act} : The actual alternator speed, unit: round per minute (r/min)
- The pulse is determined by the peak voltage U_n , the clamping voltage U_s , the internal resistance R_i , and the pulse duration t_d ; in all cases small values of U_n are correlated with small values of R_i and t_d , and high values of U_n with high values of R_i and t_d . For the test voltage U_A please refer to ISO16750-1.

How to recall this waveform from menu (take Test A 12V as an example):

1. Press the composite keys **[Shift]+[I-set]** (Function) on the front panel to enter the function menu.
2. Use the knob or press the Up/Down key to select **3.Road-Vehicles = Off** and press **[Enter]**.
3. Press the Left/Right key to select **ISO16750-2** and press **[Enter]** to confirm.
4. Press the Left/Right key to select **Load-Dump**, and press **[Enter]** to confirm.
5. Press the Left/Right key to select **Test A**, and press **[Enter]** to confirm.
6. Press the Left/Right key to select **12V**, and press **[Enter]** to confirm.
7. Set the **Td** and **Un** in turns, and press **[Enter]** to confirm.

The interface returns to the main interface of the system and displays **LOAD-DUMP**.

8. Press **[On/Off]** on the front panel to turn on the output.
9. According to the selected trigger method (same as the trigger method of the LIST function), for example, press **[Shift]+[On/Off]**(Trigger) to trigger the output of the waveform.

4.6.3.3 42V Road Vehicles — Electrical and Electronic Equipment for a Supply Voltage of 42 V — Electrical loads

A test wave completely conforming to International Standard ISO21848 is built inside the device, which can be used for the test of Electrical and electronic equipment for a supply voltage of 42V - Electrical loads. The user can directly and quickly recall this function during test.

ISO21848	Simulate the curve of “Electrical and electronic equipment for a supply voltage of 42 V — Electrical loads”	
	$U_{max,dyn}$	$U_{max,dyn}$ Test pulse
	Momentary-Drop	Transit voltage drop
	Reset	Reset test supply voltage
		Ulow Set supply voltage
	Start	Startup pulse

Recall the Waveform

Take **Momentary-Drop** as an example to introduce the procedures as follows:

1. Press the composite keys **[Shift]+[I-set]** (Function) on the front panel to enter the function menu.
2. Use the knob or press the Up/Down key to select **3.Road-Vehicles = Off** and press **[Enter]**.
3. Press the Left/Right key to select **ISO21848**, and press **[Enter]** to confirm.
4. Press the Left/Right key to select **Momentary-Drop**, and press **[Enter]** to confirm.

The interface returns to the main interface of the system and displays **MOMENTARY-DROP**.

5. Press **[On/Off]** on the front panel to turn on the output.
6. According to the selected trigger method (same as the trigger method of the LIST function), for example, press **[Shift]+[On/Off]**(Trigger) to trigger the output of the waveform.

$U_{max,dyn}$ Test Pulse

Detect the function when the DUT is under maximum dynamic Voltage $U_{max,dyn}$, and simulate the maximum dynamic Voltage of high-energy pulse raised from

throw load in 42V electrical system, where the upper limit is the protection voltage of throw load.

After turning on **[On/Off]** and triggering the waveform output, the instrument will apply a test pulse to the DUT, as shown below:

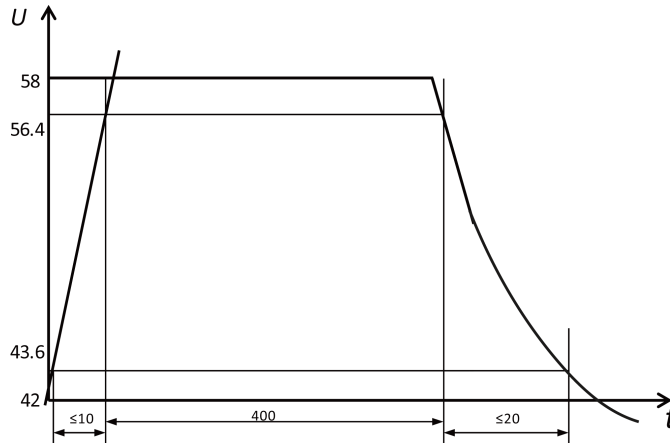

- t: Time (in ms)
- U: Voltage (in V)

Supply Voltage Transient Drop

Simulate the affect from short circuit when fuse element of another circuit is melt. Detect the function status of the DUT at transient drop of Voltage.

After turning on **[On/Off]** and triggering the waveform output, when the given test pulse is applied at all input terminals of the DUT, the rise and fall time between U_{low} and 16V level shall not be longer than 100ms.

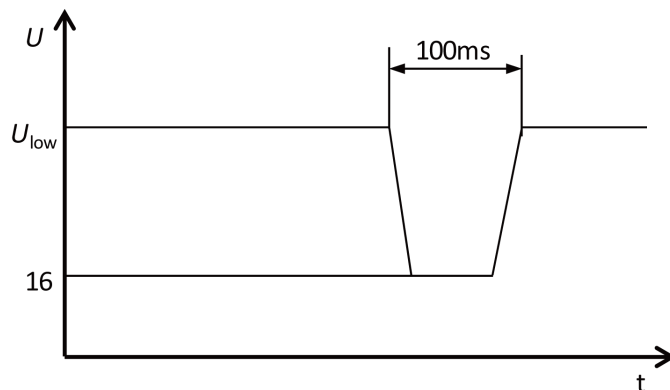

- t: Time (in ms)
- U: Voltage (in V)

Reset Performance at Transient Drop of Voltage

Detect the reset performance of the DUT at different Voltage drops. Applicable for devices with reset function (for example, device installed with one or several micro controllers) .

After turning on **[On/Off]** and triggering the waveform output, the instrument will apply test pulse and detect the reset performance of the DUT, as shown in the figure below.

The supply voltage drops from U_{low} to $0.95U_{low}$ by 5% and keeps for 5s, and then rise to U_{low} and keep for at least 10s for function test. Then, drop Voltage to $0.9U_{low}$, and so on. As shown in the figure below, drop the voltage from U_{low} to 0V by 5% and raise the voltage to U_{low} . The Rise and Fall time shall be between 10ms and 1s.

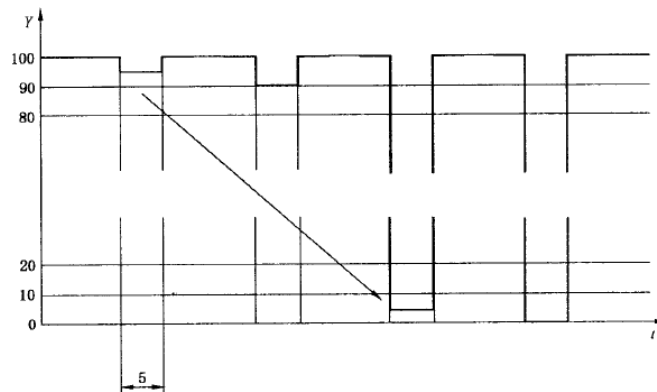

- t: Time (in s)
- Y: U_{low} , %

Start-up Characteristics

Detect DUT characteristics before and after vehicle startup.

After turning on **[On/Off]** and triggering the waveform output, the instrument will apply the startup characteristic parameters as shown in the figure and table below to related input terminals of the DUT simultaneously.

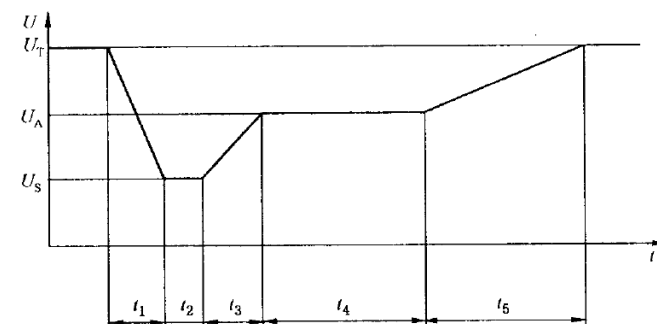

- t: Time time (in ms) t1: 5ms

- U: Voltage (in V) t2: 15ms
- U_s: 18V t3: 50ms
- U_A: 21V t4: 10000ms
- U_T: 42V t5: 100ms

4.6.3.4 SAEJ1113-11 Waveform Protocol

SAEJ1113-11 Waveform protocol related parameters are described as follows:

SAEJ1113-11	SAEJ1113-11 Waveform protocol		
	Test-2B	Transient from DC motors acting as generators after ignition switch OFF	
		12V	Select the 12V voltage system
			Td Test pulse width
		24V	Select the 24V voltage system
			Td Test pulse width
	Test-4	Starter motor engagement disturbance pulse	
		12V	Select the 12V voltage system
			Vs For details, see Table 4-1 Parameter Description
			Va
			T7
			T9
			T11
		24V	Select the 24V voltage system
			Vs For details, see Table 4-1 Parameter Description
			Va
		T7	
		T9	
		T11	
Test-5	Load dump waveform		
	Test A	Select centralized load dump unsuppression	

			12V	Select the 12V voltage system			
				Td	Test pulse width		
				Un	Peak voltage		
				Us	Clamping voltage		
			24V	Select the 24V voltage system			
				Td	Test pulse width		
			Un	Peak voltage			
			Us	Clamping voltage			
		Test B	Select centralized load dump suppression				
					12V	Select the 12V voltage system	
						Td	Test pulse width
						Un	Peak voltage
	Us			Clamping voltage			
24V	Select the 24V voltage system						
	Td			Test pulse width			
	Un	Peak voltage					
	Us	Clamping voltage					

Test-2B

Transient from DC motors acting as generators after ignition switch OFF:

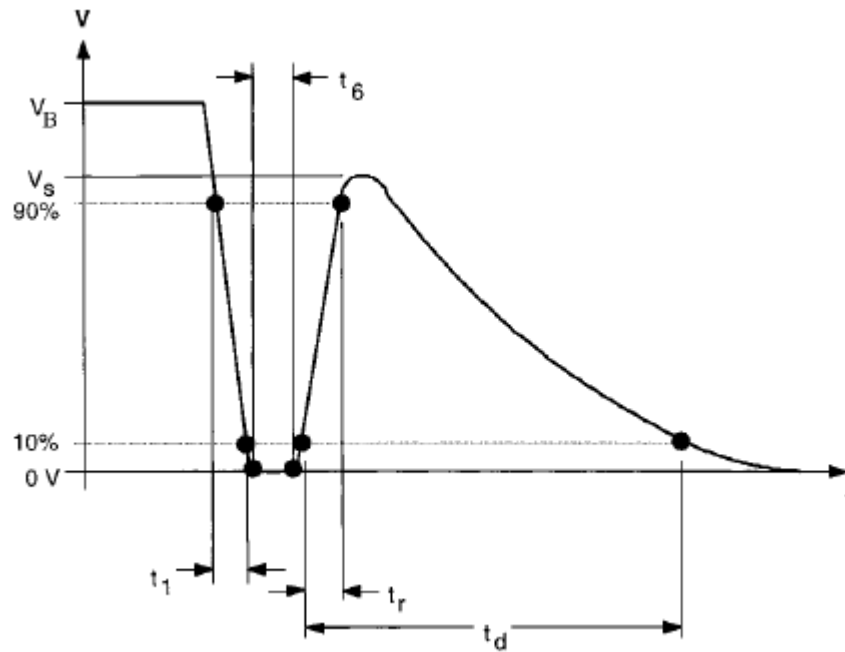

Parameters	12V	24V
V_S	10V	20V
R_i	$\leq 0.05\Omega$	$\leq 0.05\Omega$
t_d	0.2–2s	0.2–2s
t_1	1ms \pm 50%	1ms \pm 50%
t_r	1ms \pm 50%	1ms \pm 50%
t_6	1ms \pm 50%	1ms \pm 50%

Test-4

Starter motor engagement disturbance pulse.

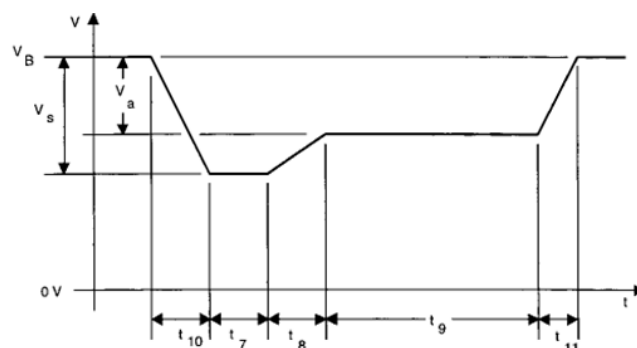

Table 4–1 Parameter Description

Parameters	12V	24V
V_S (From V_B)	-4V to -7V	-5V to -16V
V_a (From V_B)	-2.5 to -6V with $ V_a \leq V_S $	-5 to -12V with $ V_a \leq V_S $
R_i	0Ω to 0.02Ω	0Ω to 0.02Ω
t_7	15 to 40ms ⁽¹⁾	50 to 100ms ⁽¹⁾
t_8	≤50ms	≤50ms
t_9	0.5 to 20s ⁽¹⁾	0.5 to 20s ⁽¹⁾
t_{10}	5ms	10ms
t_{11}	5 to 100ms ⁽²⁾	10 to 100 ms ⁽³⁾

(1). The value used should be agreed between the vehicle manufacturer and the equipment supplier to suit the proposed application.

(2). $t_{11}=5$ ms is typical of the case when engine starts at the end of the cranking period, while $t_{11}=100$ ms is typical of the case when the engine does not start.

(3). $t_{11}=10$ ms is typical of the case when engine starts at the end of the cranking period, while $t_{11}=100$ ms is typical of the case when the engine does not start.

Test–5

For the details, please refer to the [Load Dump Dynamic Behavior](#).

4.6.3.5 LV123

LV123 has been compiled for the electrical characteristics of new energy vehicles for major European car manufacturers. For its high-voltage system parts, the state standard within its operating voltage range is defined. The relevant parameters are introduced as follows:

WARNING

Please pay attention to whether the voltage value defined in the LV123 standard matches the rated voltage of the instrument, otherwise some waveforms cannot be recalled.

LV123	LV123 waveform protocol	
	Curve	Choose to recall the standard LV123 waveform.
	Run	Run the presently recalled waveform.
	Open	Recall the waveform saved inside the instrument.
	Recall File	The address of the waveform file, ranging from 1 to 10.
	Edit	Edit the waveform curve.
	unlimited	Range of unlimited operating capability, includes the following options: <ul style="list-style-type: none"> • HV_1 • HV_2a • HV_2b • HV_3
	upper-limited	Range of upper limited operating capability, includes the following options: <ul style="list-style-type: none"> • HV_1 • HV_2a • HV_2b • HV_3
	lower-limited	Range of lower limited operating capability, includes the following options: <ul style="list-style-type: none"> • HV_1 • HV_2a • HV_2b • HV_3
	highly-limited	Range of highly limited operating capability, includes the following options: <ul style="list-style-type: none"> • HV_1 • HV_2a • HV_2b

		start voltage	Set the initial output voltage of the instrument before the LV123 regulation waveform test. At the same time, this value is also the end voltage after the regulatory waveform test is completed.
		start time	Test time of starting voltage, range: 0~999.999S.
		end time	Test time of end voltage, range: 0~999.999S.
		count	Set the number of test repetitions, ranging from 1 to 65535. The actual number of test executions = count * 3.
		Save To File	Set the save address of the waveform file, range: 1~10.
	User-defined	Select the user-defined LV123 waveform.	
		Run	Run the presently recalled waveform.
		Open	Recall the waveform saved inside the instrument.
		Recall File	The address of the waveform file, ranging from 1 to 10.
		Edit	Edit a user-defined waveform.
		unlimited	Range of unlimited operating capability, with the following settings: <ul style="list-style-type: none"> • V1: Voltage in interval 1 • V2: Voltage in interval 2 • V3: Voltage in interval 3 • V4: Voltage in interval 4
		upper-limited	Range of upper limited operating capability, with the following settings: <ul style="list-style-type: none"> • V1: Voltage in interval 1 • V2: Voltage in interval 2 • V3: Voltage in interval 3

				<ul style="list-style-type: none"> • V4: Voltage in interval 4 • V5: Voltage in interval 5 • V6: Voltage in interval 6
			lower-limited	Range of lower limited operating capability, with the following settings: <ul style="list-style-type: none"> • V1: Voltage in interval 1 • V2: Voltage in interval 2 • V3: Voltage in interval 3 • V4: Voltage in interval 4 • V5: Voltage in interval 5 • V6: Voltage in interval 6
			highly-limited	Range of highly limited operating capability, with the following settings: <ul style="list-style-type: none"> • V1: Voltage in interval 1 • V2: Voltage in interval 2 • V3: Voltage in interval 3 • V4: Voltage in interval 4 • V5: Voltage in interval 5
			start voltage	Set the initial output voltage of the instrument before the LV123 regulation waveform test. At the same time, this value is also the end voltage after the regulatory waveform test is completed.
			start time	Test time of starting voltage, range: 0~999.999S.
			end time	Test time of end voltage, range: 0~999.999S.
			count	Set the number of test repetitions, ranging from 1 to 65535. The actual number of test executions = count * 3.
			Save To File	Set the save address of the waveform file, range: 1~10.

Unlimited

The waveform is as follows:

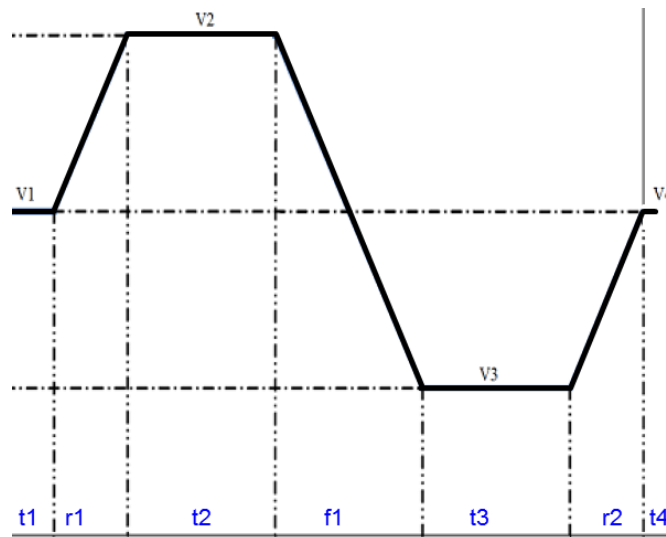

The parameters are as follows:

Parameter	HV_1	HV_2a	HV_2b	HV_3
V1	140V	255V	350V	635V
V2	190V	340V	450V	750V
V3	90V	170V	250V	520V
V4	140V	255V	350V	635V
t1	300S	300S	300S	300S
r1	3mS	5mS	5mS	6mS
t2	300S	300S	300S	300S
f1	5mS	9mS	10mS	12mS
t3	300S	300S	300S	300S
r2	3mS	5mS	5mS	6mS
t4	5mS	5mS	5mS	6mS
Actual number of tests	Count*3	Count*3	Count*3	Count*3

Upper-limited

The waveform is as follows:

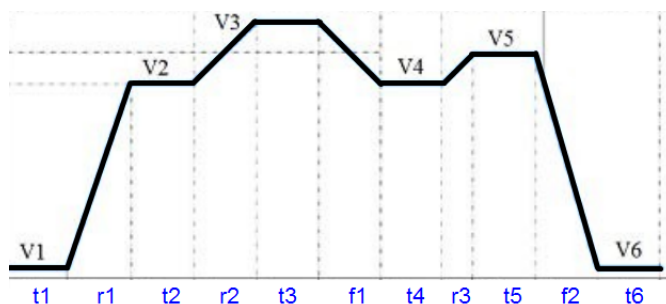

The parameters are as follows:

Parameter	HV_1	HV_2a	HV_2b	HV_3
V1	140V	255V	350V	635V
V2	190V	340V	450V	750V
V3	200V	360V	470V	770V
V4	190V	340V	450V	750V
V5	195V	350V	460V	760V
V6	140V	255V	350V	635V
t1	60S	60S	60S	60S
r1	3mS	5mS	5mS	6mS
t2	60S	60S	60S	60S
r2	60S	60S	60S	60S
t3	60S	60S	60S	60S
f1	60S	60S	60S	60S
t4	60S	60S	60S	60S
r3	1mS	1mS	1mS	1mS
t5	60S	60S	60S	60S
f2	3mS	5mS	6mS	7mS
t6	60S	60S	60S	60S
Actual number of tests	Count*3	Count*3	Count*3	Count*3

Lower-limited

The waveform is as follows:

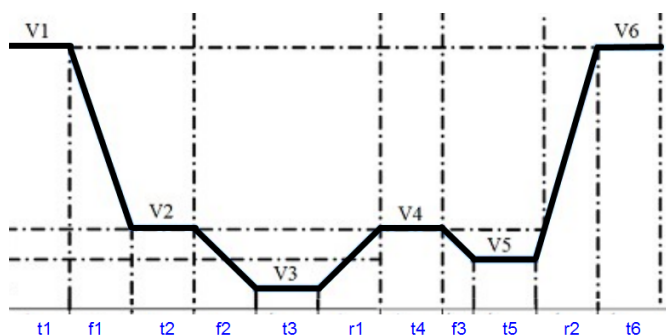

The parameters are as follows:

Parameter	HV_1	HV_2a	HV_2b	HV_3
V1	140V	255V	350V	635V
V2	90V	170V	250V	520V
V3	80V	160V	200V	450V
V4	90V	170V	250V	520V
V5	85V	165V	225V	485V
V6	140V	255V	350V	635V
t1	60S	60S	60S	60S
f1	3mS	5mS	5mS	6mS
t2	60S	60S	60S	60S
f2	60S	60S	60S	60S
t3	60S	60S	60S	60S
r1	60S	60S	60S	60S
t4	60S	60S	60S	60S
f3	1mS	1mS	2mS	2mS
t5	60S	60S	60S	60S
r2	3mS	5mS	7mS	8mS
t6	60S	60S	60S	60S
Actual number of tests	Count*3	Count*3	Count*3	Count*3

Highly-limited

The waveform is as follows:

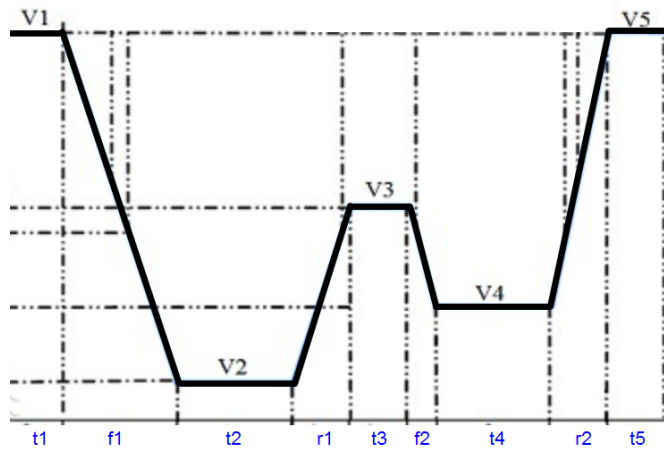

The parameters are as follows:

Parameter	HV_1	HV_2a	HV_2b
V1	140V	255V	350V
V2	60V	120V	150V
V3	85V	165V	225V
V4	70V	140V	175V
V5	140V	255V	350V
t1	60S	60S	60S
f1	4mS	7mS	10mS
t2	60S	60S	60S
r1	60S	60S	60S
t3	60S	60S	60S
f2	60S	60S	60S
t4	60S	60S	60S
r2	4mS	6mS	9mS
t5	60S	60S	60S
Actual number of tests	Count*3	Count*3	Count*3

How to Use

The following is an example of how to use this function by recalling the LV123 standard regulation Unlimited and HV_1 waveform.

1. Press the composite keys **[Shift]+[I-set]** (Function) on the front panel to enter the function menu.
2. Use the knob or press the Up/Down key to select **3.Road-Vehicles = Off** and press **[Enter]**.
3. Press the Left/Right key to select **LV123**, and press **[Enter]** to confirm.
4. Press the Left/Right key to select **Curve**→**Edit**→**unlimited**→**HV_1**, and press **[Enter]** to confirm.
5. Set **start voltage = 50V**, **start time = 0.1S**, **end time = 0.1S** and **count = 1**.
6. Set **Save To File = 1**, and press **[Enter]** to confirm.
7. Select **Open**→**Recall File** in the main interface of LV123. Set to **1**, and press **[Enter]** to confirm.
8. Select **RUN** in the main interface of LV123, and press **[Enter]** to confirm.

At this time, the information of the recalled waveform is displayed in the lower right corner of the VFD screen: R1/HV_1/00001, which is represented as the interval type of the waveform, the type of the regulation, and how many times the waveform has been executed cyclically.

9. Press **[On/Off]** on the front panel to turn on the output.
10. According to the selected trigger method (same as the trigger method of the LIST function), for example, press **[Shift]+[On/Off]**(Trigger) to trigger the output of the waveform.

4.6.3.6 LV124

The built-in curves LV124 can meet general requirements, test conditions and tests of electrical and electronic components in motor vehicles up to 3.5 t. Related parameters are as below:

LV124	LV124 waveform protocol	
	E-02	Transient overvoltage test waveform
	E-04	Jump start test waveform
	E-05	Load dump test waveform
	E-07	Slow decrease and increase of the supply voltage test waveform
	Ubmax	Start voltage
	Ubmin	Holding voltage

		Ubmin Holding Time	Voltage holding time at Ubmin	
E-08	Slow decrease, quick increase of the supply voltage test waveform			
		Ubmax	Start voltage	
		Ubmin	Holding voltage	
		Ubmin Holding Time	Voltage holding time at Ubmin	
E-09	Reset behavior test waveform			
		Ubmin	Holding voltage	
E-11	Start pulses			
		Cold-Start	Cold start	
			Normal	Standard experimental pulse
			Severe	Enhanced experimental pulse
		Warm-Start	Warm start	
E-12	Voltage curve with intelligent generator control			
		U	Voltage drop between DUT and battery terminals	

E-02 Transient Overvoltage Pulse

Transient overvoltages may occur in the electric system due to the switching off of loads and due to short accelerator tip-ins. These overvoltages are simulated by means of this test. This test may be used for the electrical life test. The test pulse of E-02 Transient overvoltage is shown in the figure below:

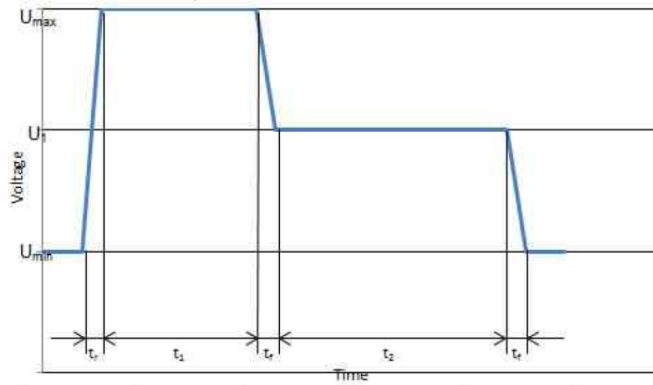

E-04 Jump Start

External starting of the vehicle is simulated. The maximum test voltage results from commercial vehicle systems and their increased power supply voltage. The test pulse of E-04 Jump start is shown in the figure below:

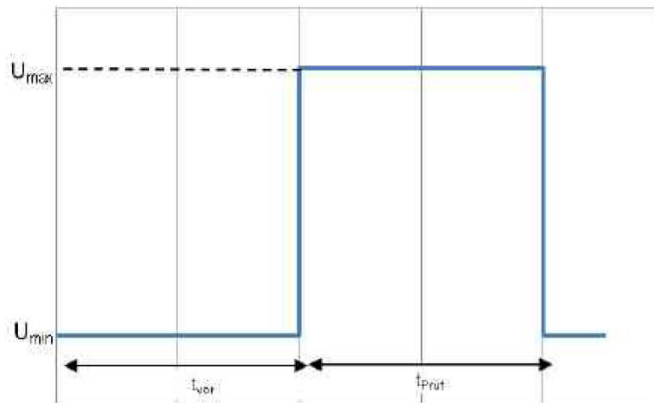

E-05 Load Dump

Dumping of an electric load, in combination with a battery with reduced buffering ability, results in an energy-rich overvoltage pulse due to the generator characteristics. The test pulse of E-05 Load Dump is shown in the figure below:

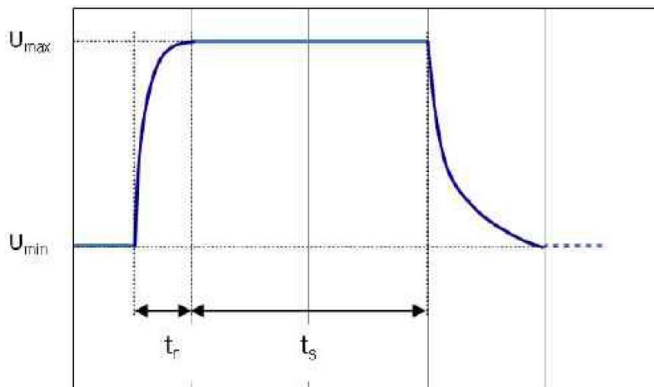

E-07 Slow Decrease and Slow Increase of the Supply Voltage

The slow decrease and increase of the supply voltage is simulated as it occurs during the slow discharging and charging procedure of the vehicle battery. The waveform is as follows.

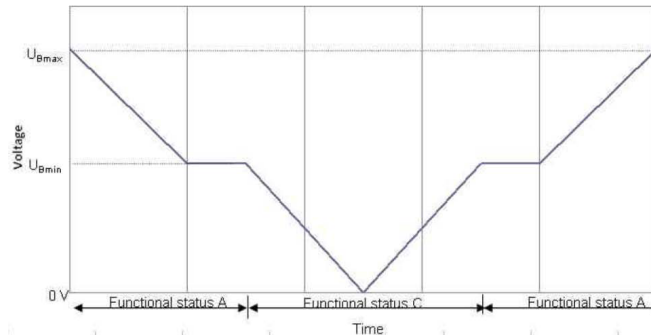

E-08 Slow Decrease and Quick Increase of the Supply Voltage

This test simulates the slow decrease of the battery voltage to 0 V and the sudden reconnection of the battery voltage e.g. by means of applying a jump start source. The waveform is as follows.

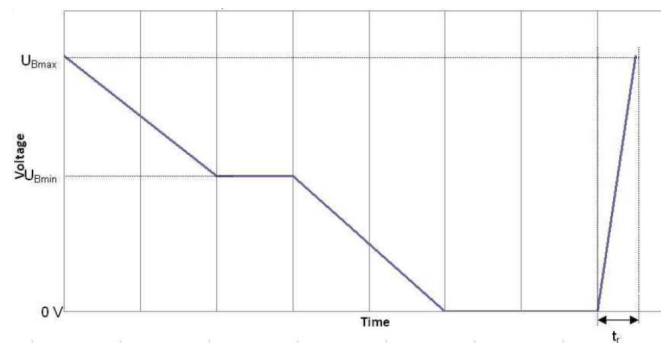

E-09 Reset Behavior

The reset behavior of a component in its environment is simulated and tested. Test boundary conditions (e.g. assembly, terminal, system) must be described in detail.

During operation, an arbitrary sequence of repeated switching-on/off procedures occurs; this must not lead to an undefined behavior of the component. The reset behavior is represented by a voltage variance and a time variance. Two different test sequences are required to simulate different switchoff times. A component must always undergo both sequences.

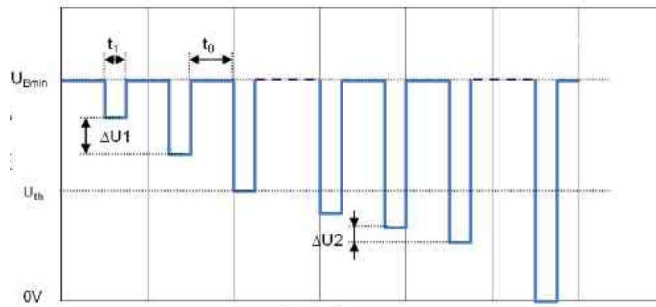

E-11 Start Pulses

When starting the engine, the battery voltage drops to a low value for a short period and then slightly rises again. Most components are activated directly before starting for a short period, then deactivated during starting and activated again after starting when the engine is running. This test serves to verify normal operation under these conditions. The starting process may be performed under different vehicle starting conditions, cold start and warm start. In order to cover both cases, two different test sequences are required. A component must always undergo both sequences.

- Cold Start Test Pulse

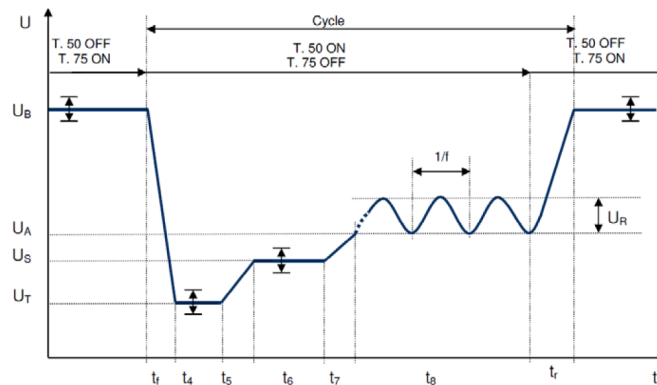

- Warm Start Test Pulse

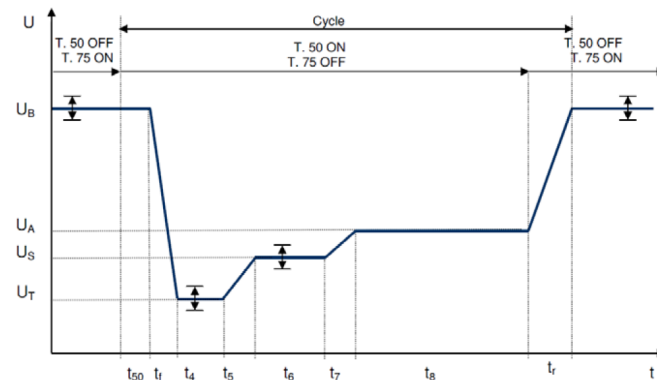

E-12 Voltage Curve with Intelligent Generator Control

The behavior of the electric system when intelligent generator controls are used is simulated.

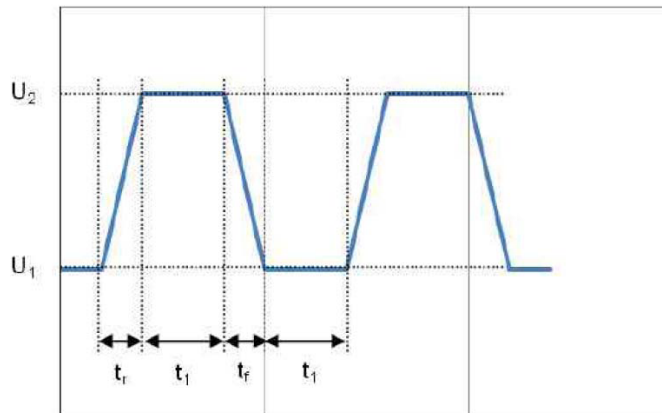

4.6.3.7 LV148

LV148 covers tests for electric and electronic components in motor vehicles 48V electrical system. The voltage level and definition are shown in the figure below.

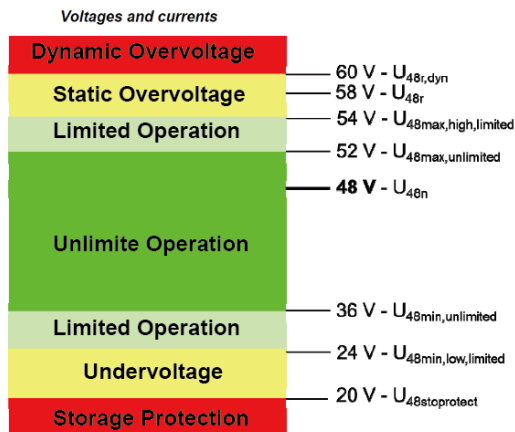

The related parameters of the built-in waveform of the instrument are introduced as follows:

LV148	LV148
E-01	Long-term overvoltages The component's resistance to long-term overvoltage is tested. A generator control fault during driving operation is simulated.
E-02	Transient overvoltages

	Transient overvoltages may occur in the electric system due to the switching off of loads and due to short accelerator tip-ins. These overvoltages are simulated by means of this test.	
	Short	Short time mode (3 times)
	Endurance	Endurance mode (1000 times)
E-03	Transient undervoltages Transient undervoltages in the electric system may occur due to switching on of loads. These undervoltages are simulated by means of this test.	
E-04	Jumpstart / recuperation Jump starting of the vehicle is simulated. The maximum test voltage results from commercial vehicle systems and their elevated electric system voltages.	
E-06A	Slow decrease and increase of the supply voltage (without energy storage) The slow decrease and increase of the supply voltage is simulated as it occurs during the slow discharging and charging procedure of the vehicle battery.	
	T1 Holding Time	Holding time
E-06B	Slow decrease and increase of the supply voltage (with energy storage – Part 1) Checks will slow the supply voltage decrease to the energy storage protection voltage, followed by energy storage disconnection.	
	T1 Holding Time	Holding time
E-07	Slow decrease, fast increase in the supply voltage This test simulates the slow decrease of the vehicle system voltage to the energy storage protection voltage followed by shutdown to 0V and the sudden reconnect the system voltage by a charged or new energy storage battery.	
	T1 Holding Time	Holding time
	T1 Rising Time	Rising time
E-08	Reset behavior	

	The reset behavior of a component in its environment is simulated and tested. Test boundary conditions (e.g., assembly, terminal, system) must be described in detail. During operation, an arbitrary sequence of repeated switching-on/off procedures occurs; this must not lead to an undefined behavior of the component. The reset behavior is represented by a voltage variance and a time variance. Two different test sequences are required to simulate different switch-off times. A component must always undergo both sequences.	
E-10	Start impulses During a cold start (motor start), the energy storage battery voltage decreases for a short, then increases again. The warm start is not considered, because the operating range is maintained.	
	Normal	Standard experimental pulse
	Severe	Enhanced experimental pulse
E-15	Operation in the range without function restriction The operating behavior at the range limits is checked.	
E-16	Operation in the upper range with function limitation The operating behavior with change and at the range limits is checked.	
E-18	Overvoltage range The test is to show the load cut-off during storage charging and check the changes of the operating behavior into the overvoltage range.	

E-01

The waveform is as follows:

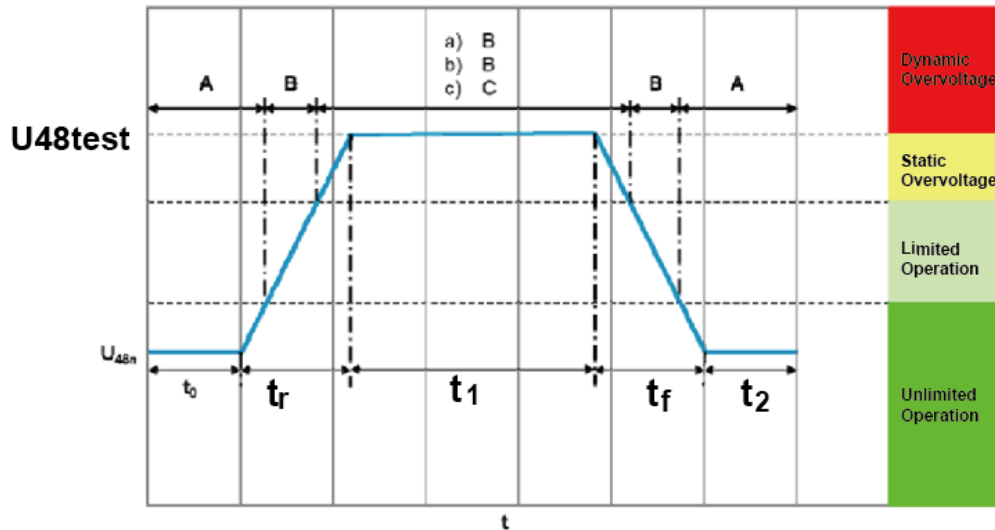

- t_r 0.1 s
- t_1 60 min.
- t_f 0.1 s
- t_2 1 s
- Test voltage U_{48test} $U_{48r,dyn}$

E-02

The waveform is as follows:

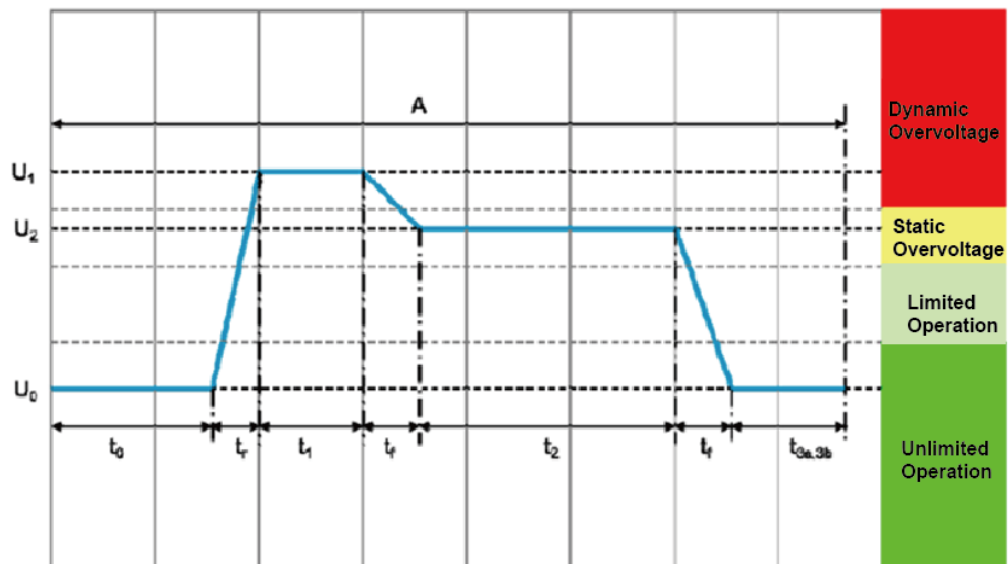

• U_0	U_{48n}
• U_1	70 V
• U_2	U_{48r}
• t_0	100 ms
• t_r	1 ms
• t_1	100 ms
• t_f	1 ms
• t_2	600 ms
• t_{3a}	2.5 s
• t_{3b}	9 s
• R_i	$10 \text{ m}\Omega \leq R_i \leq 100 \text{ m}\Omega$
• Number of cycles:	1- Short test: 3 times with t_{3b} 2- Endurance test: 1000 times with t_{3b}

E-03

The waveform is as follows:

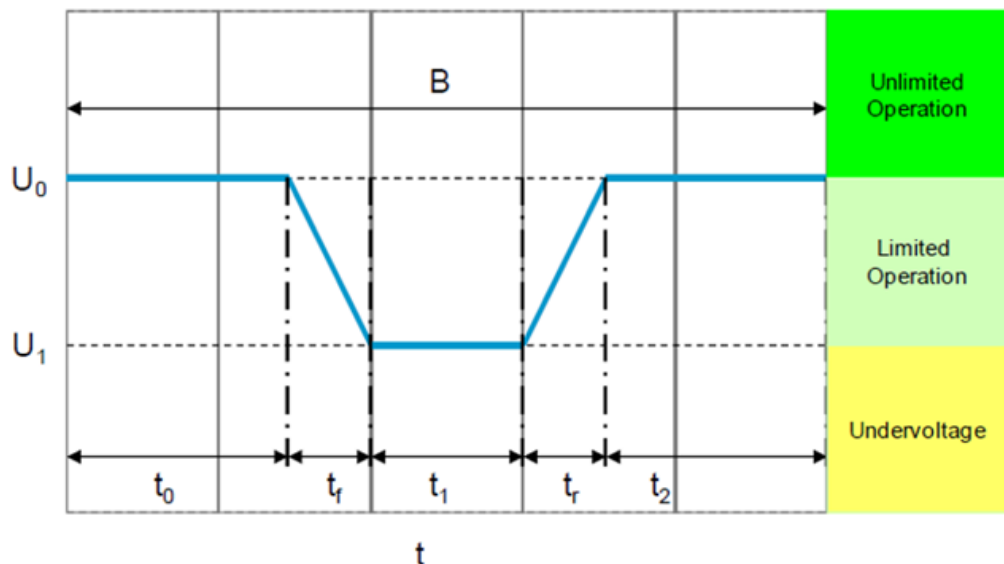

▾ Test parameters:

• U_0	$U_{48min,unlimited}$
• U_1	$U_{48min,low,limited}$
• t_0	60 s
• t_r	2 ms
• t_1	500 ms
• t_r	2 ms
• t_2	500 ms
• Number of cycles:	1

E-04

The waveform is as follows:

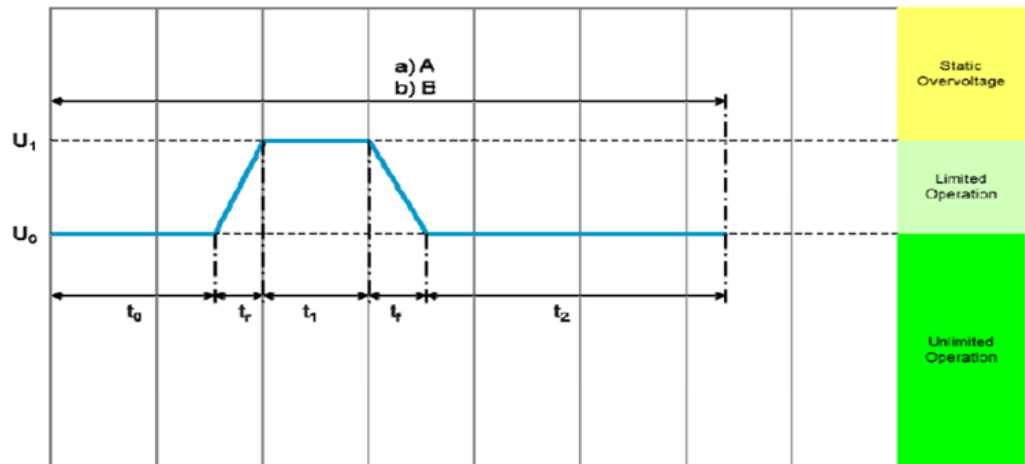

Test parameters:

- | | |
|---------------------|--------------------------|
| • U_0 | $U_{48max,unlimited}$ |
| • U_1 | $U_{48max,high,limited}$ |
| • t_0 | 60 s |
| • t_r | 100 ms |
| • t_1 | 60 s |
| • t_f | 100 ms |
| • t_2 | 60 ms |
| • Number of cycles: | 1 |

E-06A

The waveform is as follows:

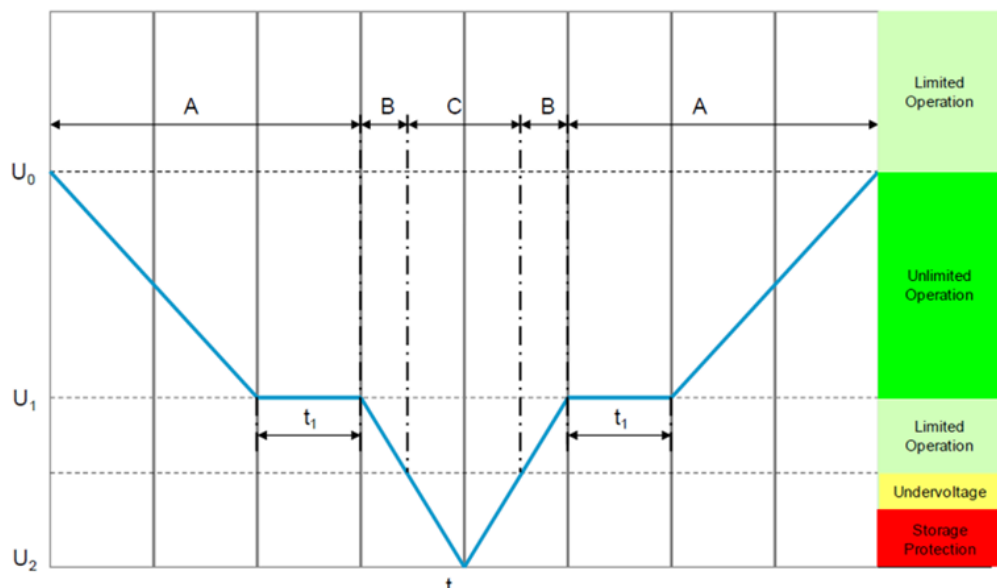

Test parameters:

• U_0	$U_{48max,unlimited}$
• Voltage gradient (ΔU)	$\pm 2 \text{ V/min}$
• U_1	$U_{48min,unlimited}$
• U_2	0 V
• t_1	until the error memory has been read
• Number of cycles:	1

E-06B

The waveform is as follows:

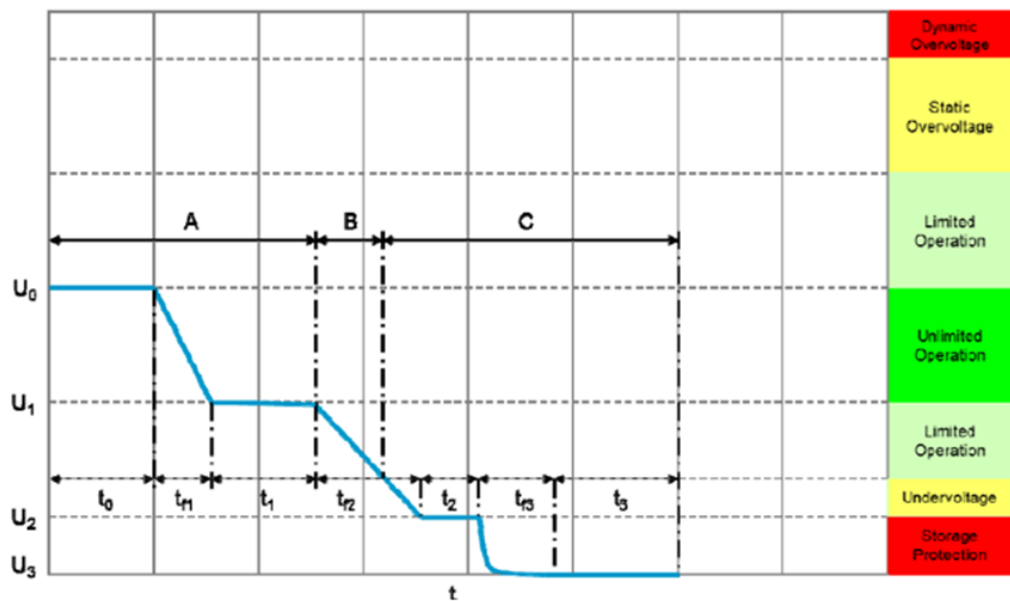
Test parameters:

• U_0	$U_{48max,unlimited}$
• U_1	$U_{48min,unlimited}$
• U_2	$U_{48stopprotect}$
• U_3	0V
• t_0	100ms
• t_{f1}	8min
• t_2	60s
• Number of cycles:	1

E-07

The waveform is as follows:

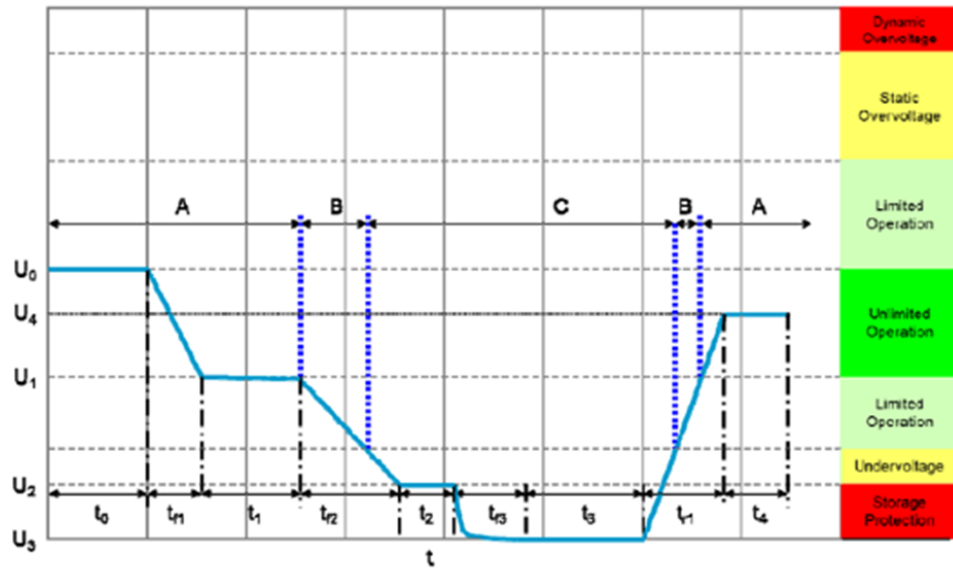

Test parameters:

- | | |
|---------------------|-----------------------|
| • U_0 | $U_{48max,unlimited}$ |
| • U_1 | $U_{48min,unlimited}$ |
| • U_2 | $U_{48stopprotect}$ |
| • U_3 | 0 V |
| • U_4 | U_{48n} |
| • t_0 | 100ms |
| • t_{r1} | 8 min |
| • t_1 | $\geq 60s$ |
| • t_{r2} | 8 min |
| • t_2 | 60 s |
| • t_{r3} | 3 s |
| • t_3 | 300 s |
| • t_{r1} | ≤ 100 ms |
| • t_4 | 100 ms |
| • Number of cycles: | 1 |



Note

T1 and tr1 need to be manually set by the user.

E-08

The waveform is as follows:

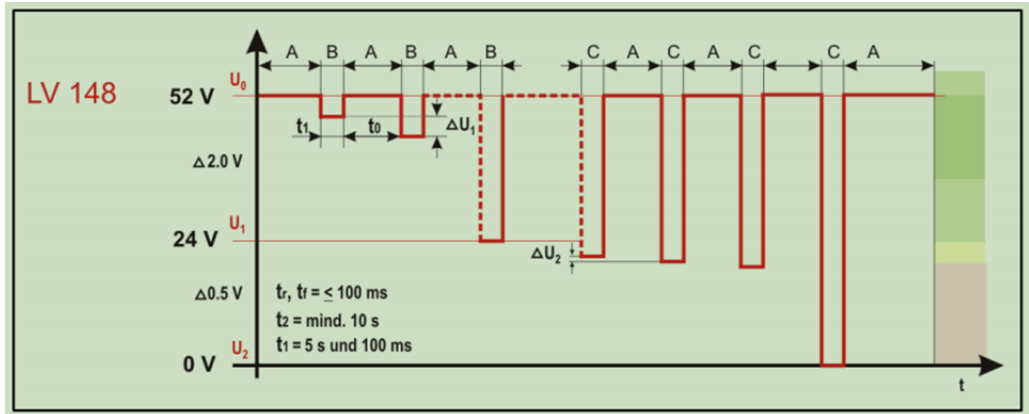

E-10

The waveform is as follows:

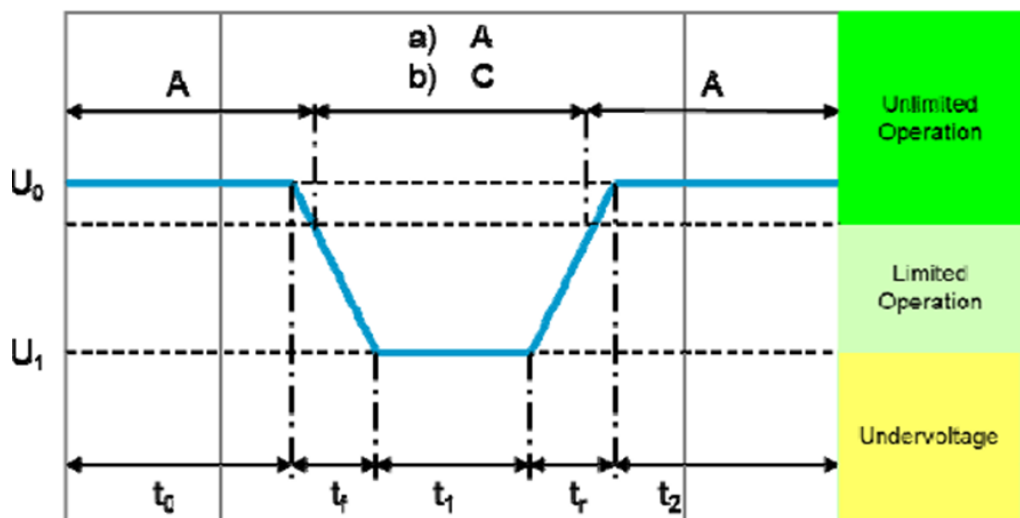

Test pulse parameters for E48-10 Starting pulses

Parameters	Test pulse "normal"
Test pulse	Test pulse "normal" and "severe"
U_0	U_{48n} for cold start normal 40 V for cold start severe
U_1	$U_{48min,low,limited}$
t_0	2s
t_f	1ms
t_1	1s
t_r	1 ms
t_2	2s
Test cycles	10

E-15

The waveform is as follows:

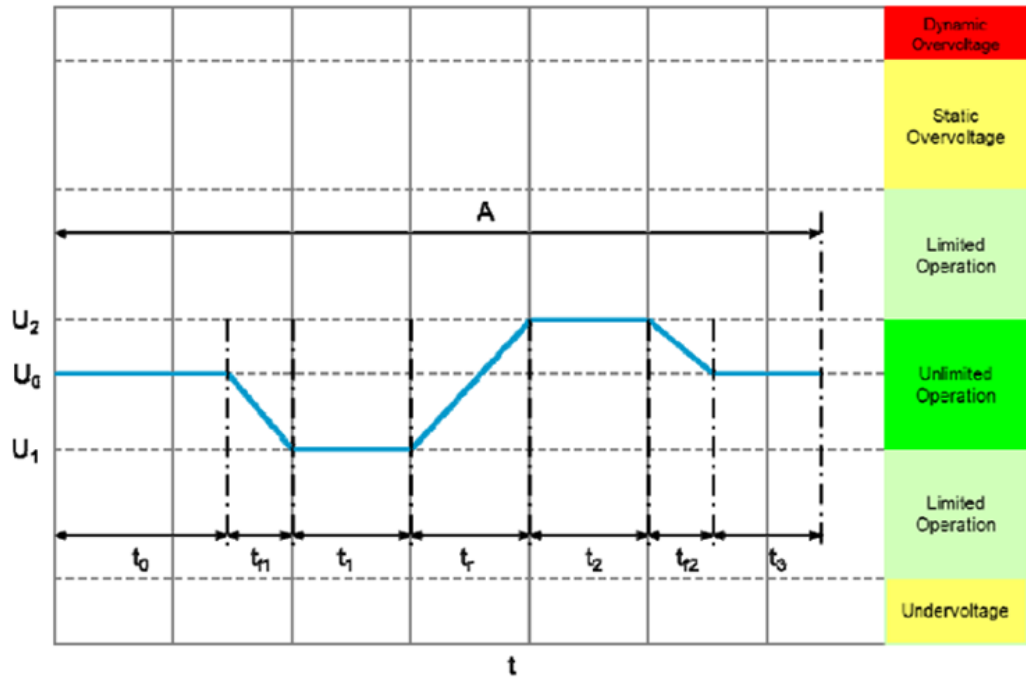

Test parameters:

• U_0	U_{48n}
• U_1	$U_{48min,unlimited}$
• U_2	$U_{48max,unlimited}$
• t_0	100ms
• t_{f1}	1ms
• t_1	1s
• t_r	1s
• t_2	10s
• t_{f2}	1s
• t_3	100ms
• Test case 1	T_{min}
• Test case 2	T_{RT}
• Test case 3	T_{max}
• Test cycles	10

E-16

The waveform is as follows:

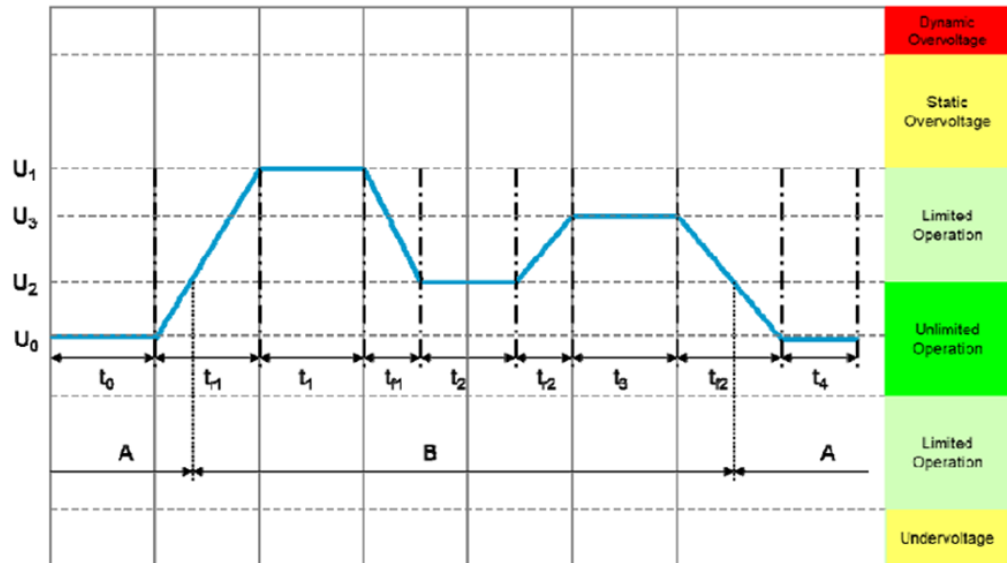

Test parameters:

• U_0	U_{48n}
• U_1	$U_{48max,high,limited}$
• U_2	$U_{48max,unlimited}$
• U_3	$U_{48max,unlimited} + 1\text{ V}$
• t_0	100ms
• t_{r1}	4s
• t_1	10s
• t_{f1}	2s
• t_2	10s
• t_{r2}	2s
• t_3	10s
• t_4	100ms

E-18

The waveform is as follows:

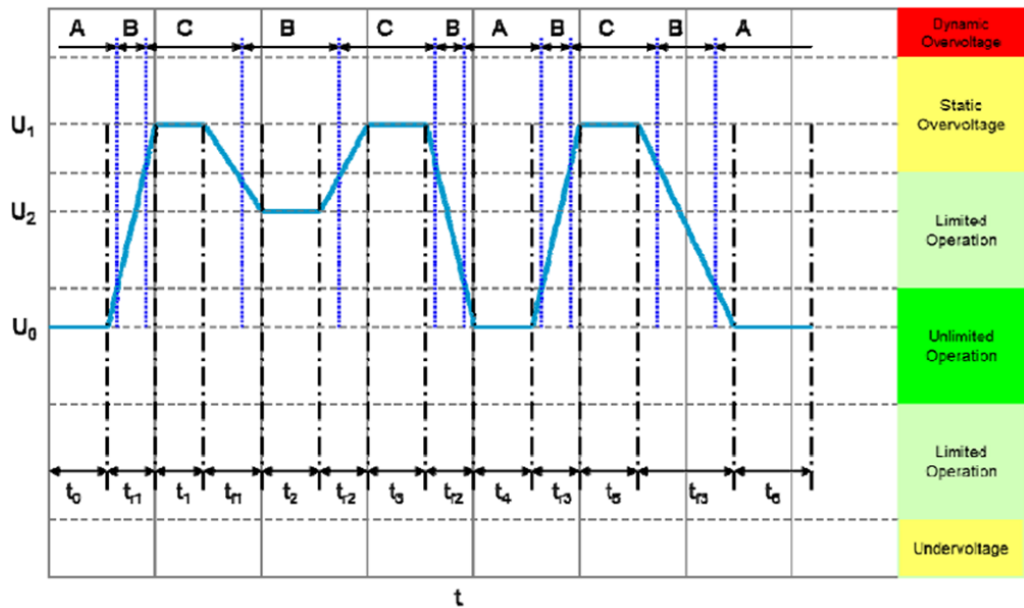

Test parameters:

• U_0	U_{48n}
• U_1	U_{48r}
• U_2	$U_{48max,unlimited} + 1 \text{ V}$
• t_0	100ms
• t_{r1}	10ms
• t_1	1s
• t_{f1}	1s
• t_2	10s
• t_{r2}	1ms
• t_3	2s
• t_{f2}	1s
• t_4	5s
• t_{r3}	10s
• t_5	2s
• t_{f3}	10s
• t_6	100ms

How to use

Take LV148 E-01 (long-term overvoltage test pulse) as an example to introduce how to use this function.

1. Press the composite keys **[Shift]+[I-set]** (Function) on the front panel to enter the function menu.

2. Use the knob or press the Up/Down key to select **3.Road-Vehicles = Off** and press **[Enter]**.
3. Use the knob or Left / Right key to select LV148, and press **[Enter]**.
4. Use the knob or Left / Right key to select **E-01**, and press **[Enter]**.

At this time, the lower right corner of the VFD screen displays the information of the recalled waveform: LV148–E01.

5. Press **[On/Off]** on the front panel to turn on the output.
6. According to the selected trigger method (same as the trigger method of the LIST function), for example, press **[Shift]+[On/Off]**(Trigger) to trigger the output of the waveform.

4.6.3.8 ISO21780

This topic covers requirements and tests for the electric and electronic components in road vehicles equipped with an electrical system operating at a nominal voltage of 48 V DC.

The related parameters of the built-in waveform of the instrument are introduced as follows:

IS- O217- 80	ISO21780 waveform	
	TEST-01	nominal voltage range
	TEST-02	<ul style="list-style-type: none"> • Upper Range: upper transitory voltage range • Lower Range: lower transitory voltage range
	TEST-03	short term overvoltage
	TEST-04	supply component load dump control test
	TEST-05	starting profile
	TEST-06	long term overvoltage
	TEST-07	overvoltage with consumer components which may supply electrical energy
	TEST-08	decrease and increase of supply voltage
	TEST-10	reinitialisation
	TEST-11	discontinuities in supply voltage

TEST-01

The purpose of this test is to verify the component functionality in the nominal voltage range.

The waveform is as follows:

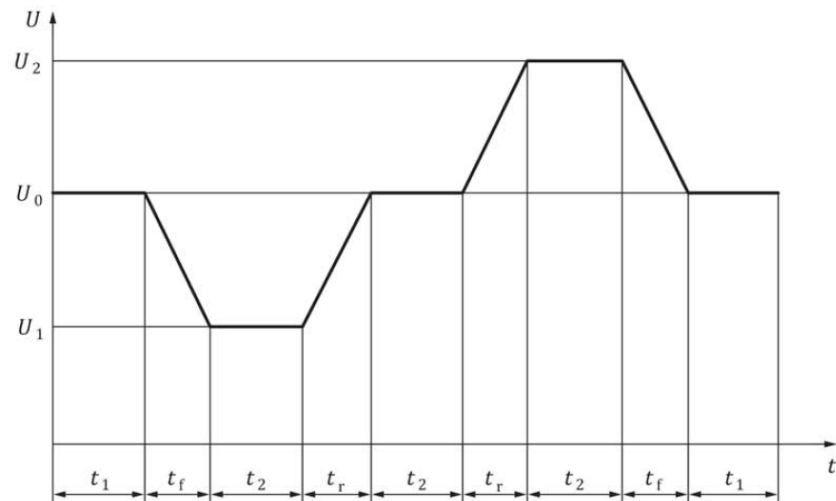
Key

t time

U test voltage

Operating mode	2.4
U_0	44 V
U_1	36 V
U_2	52 V
t_1	30 s
t_2	60 s
t_r	50 ms (0,16 V/ms)
t_f	50 ms (0,16 V/ms)
Number of cycles	5

TEST-02

The purpose of this test is to verify the functionality of the component in the upper and lower transitory voltage range.

The waveform of lower range is as follows:

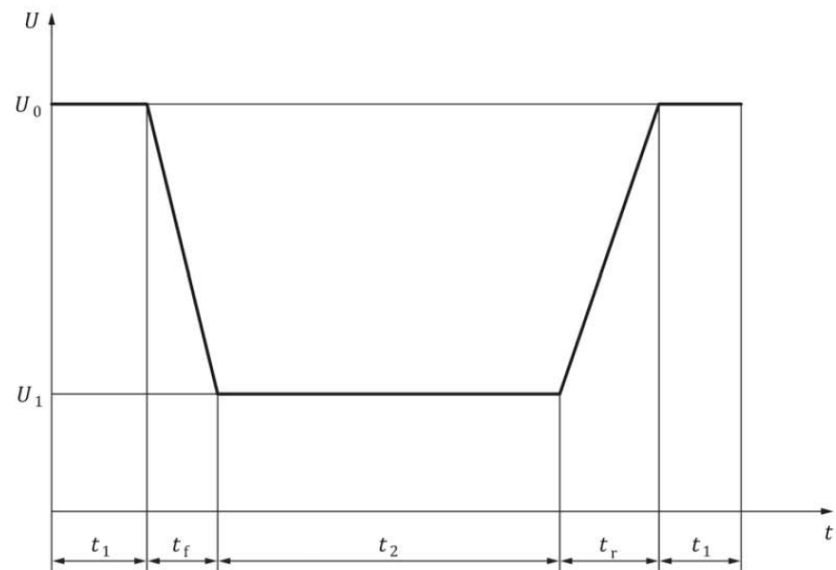

Key

t time

U test voltage

Operating mode	2.4
U_0	36 V
U_1	31 V
t_1	60 s
t_2	2 s
t_r	10 ms (0,5 V/ms)
t_f	10 ms (0,5 V/ms)
Number of cycles	5

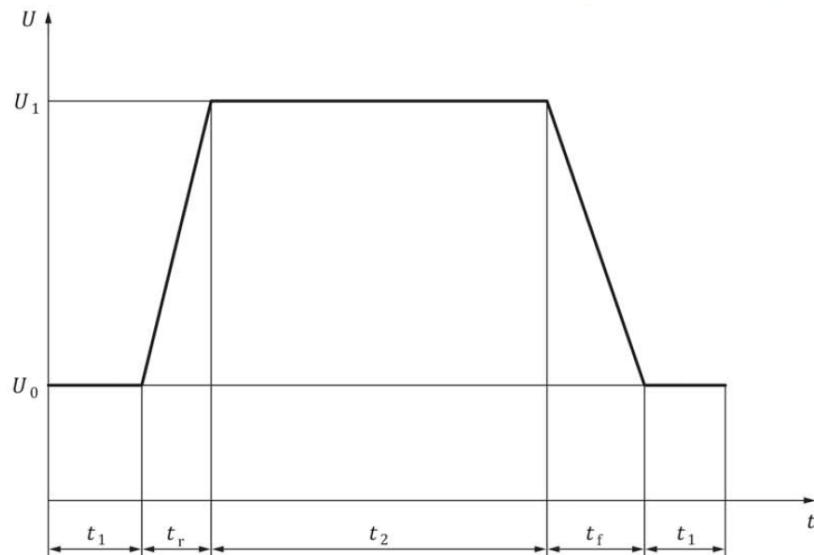
The waveform of upper range is as follows:



Key
 t time
 U test voltage

Operating mode	2.4
U_0	52 V
U_1	54 V
t_1	60 s
t_2	120 s
t_r	4 ms (0,5 V/ms)
t_f	4 ms (0,5 V/ms)
Number of cycles	5

TEST-03

This test is intended to check the immunity of the component to transient overvoltages.

The waveform is as follows:

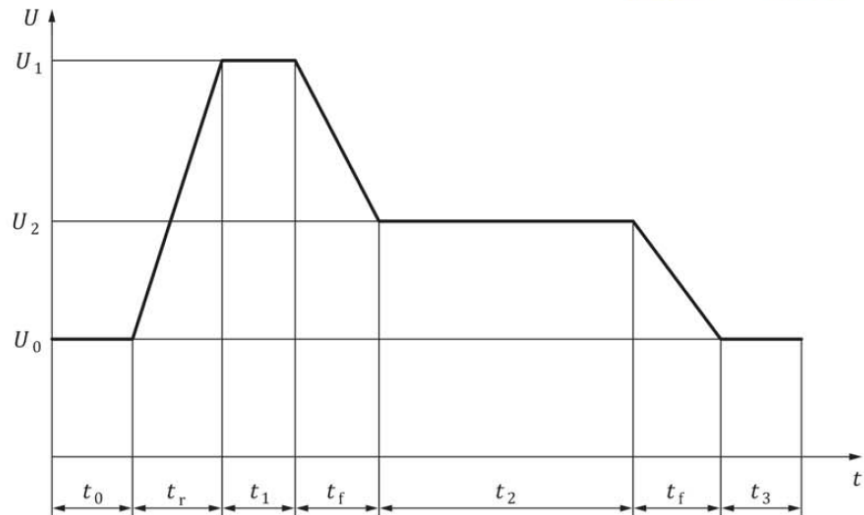
Key

t time

U test voltage

Operating mode	2.4
U_0	52 V
U_1	70 V
U_2	58 V
t_0	≥ 5 s
t_r	0,7 ms (25,71 V/ms)
t_1	40 ms
t_f	1 ms
t_2	600 ms
t_3	≥ 5 s
Number of cycles	1 000

TEST-04

This test is a simulation of a load dump situation where voltage transients occur following a sudden reduction in the load current drawn from a generator, motor-generator or DC/DC converter and whilst the battery is either out of circuit or incapable of absorbing power.

The waveform is as follows:

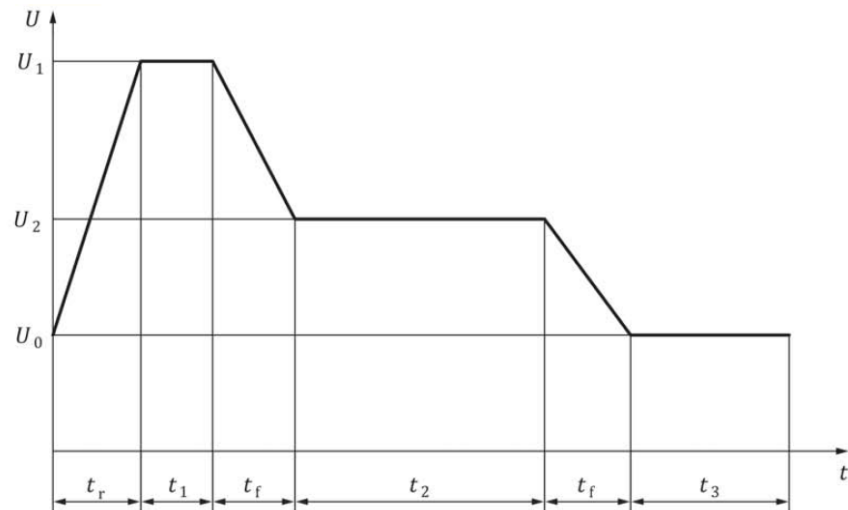

Key
 t time
 U test voltage

Operating mode	2.4
U_1	70 V
U_2	58 V
t_1	40 ms
t_2	600 ms
t_3	9 s
t_r	0,7 ms
t_f	1 ms

TEST-05

This test is intended to check the immunity of the component to voltage variations during the cold crank phase.

The waveform is as follows:

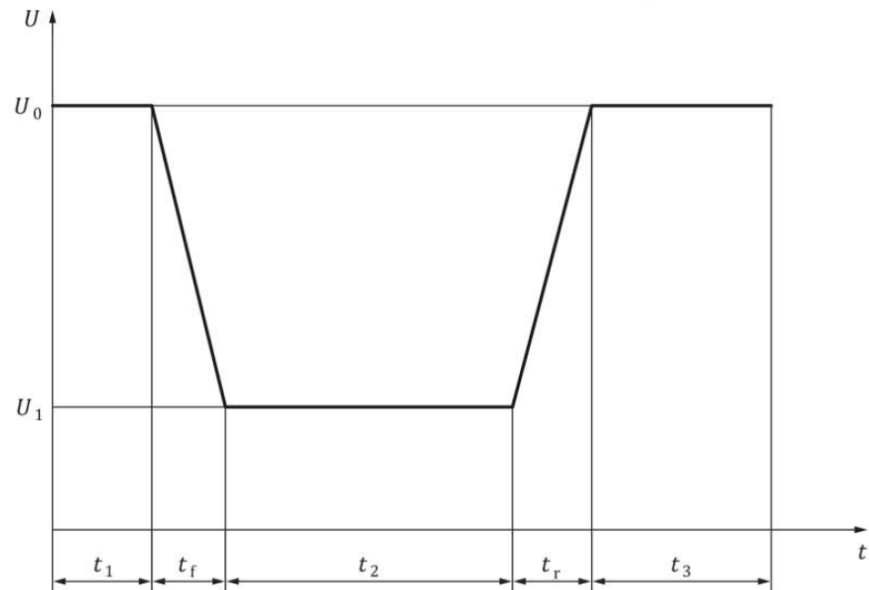
Key

t time

U test voltage

Operating mode	2.4
U_0	36 V
U_1	24 V
t_f	5 ms (2,4 V /ms)
t_2	10 s
t_r	5 ms (2,4 V/ms)
t_1	2 s
t_3	60 s
Number of cycles	10

TEST-06

This test checks the robustness of the component against a long-term overvoltage.

The waveform is as follows:

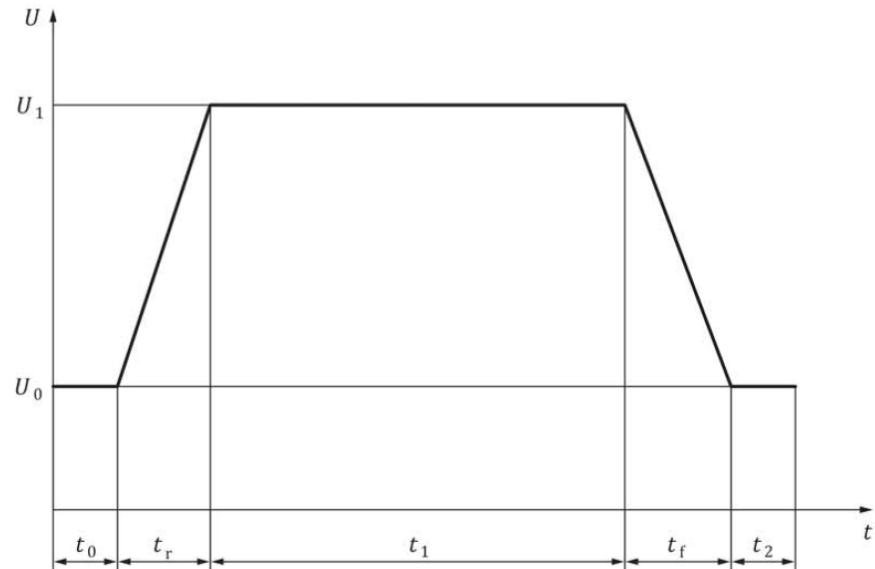
Key

t time

U test voltage

Operating mode	2.4
U_1	60 V
U_0	52 V
t_0	≥ 5 s
t_r	0,1 s (80 V/s)
t_1	60 min
t_f	0,1 s (80 V/s)
t_2	≥ 5 s
T_{test}	$T_{\text{max}} - 20$ K
Number of cycles	1

TEST-07

This test is applicable to all components which not only consume electrical energy but may also supply electrical energy with no possibility of switching off this electrical energy supply without negative effects occurring in the vehicle.

Such components shall either be capable of self-limiting their output supply voltage or systematic countermeasures shall be applied to the vehicle in order to ensure compliance with this specification.

This test does not apply to components that supply electrical energy as a primary function, such as generators. For these components TEST-04 is applicable.

The purpose of this test is to verify that the component alone complies with the voltage range specified here and is applicable where systematic countermeasures at the vehicle level are not used to ensure compliance.

The test emulates a condition where such a component supplies energy into the vehicle 48 V power supply system which can only be absorbed by the power network simulation and subsequently leads to an undesired increase in system voltage.

The waveform is as follows:

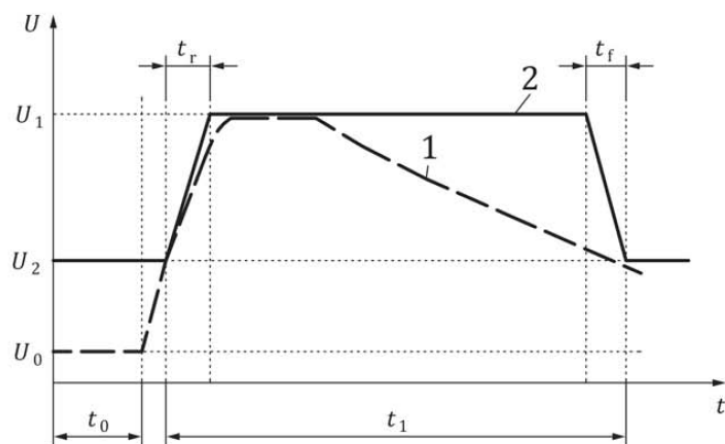

Key

- t time
- U test voltage
- 1 example of the test result of the component
- 2 limit

U_1	58 V
U_2	54 V
t_r	$\geq 160 \mu\text{s}$ (25V/ms)
t_f	$\geq 160 \mu\text{s}$ (25V/ms)
t_1	300 ms

TEST-08

This test is intended to check immunity of a component to decrease and increase of supply voltages.

The waveform is as follows:

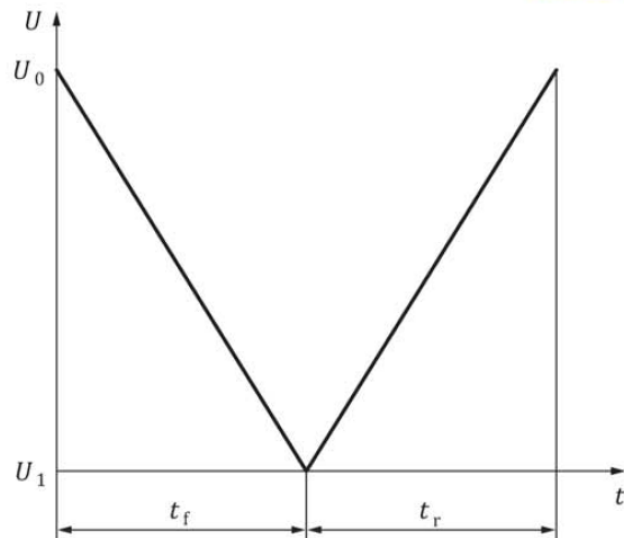
Key

t time

U test voltage

Operating mode	2.1 and 2.4
U_0	44 V
U_1	0 V
t_f	21 min (≈ 35 mV/s)
t_r	21 min (≈ 35 mV/s)
Number of cycles	1

TEST-10

This test is intended to check the correct reinitialisation of the component after interruption of onboard power supply. This test shall only be performed on DUT's whose control logic (or parts thereof) is supplied by 48 V.

The waveform is as follows:

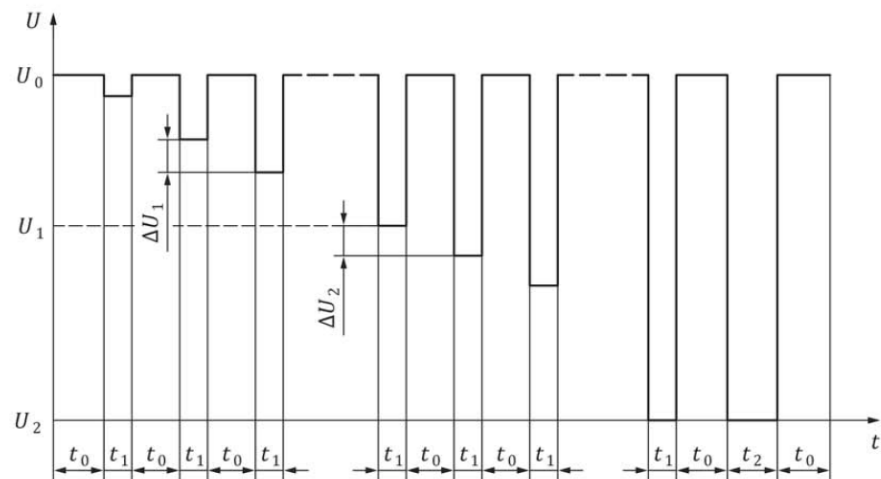
Key

t time

U test voltage

Operating mode	2.4
U_0	36 V
U_1	24 V
U_2	0 V
ΔU_1	2 V
ΔU_2	0,5 V
t_f	<100 ms
t_r	<100 ms
t_1	5 s
t_2	10 s
t_0	≥ 10 s, until the DUT becomes 100 % operational

TEST-11

The behaviour of a component when subjected to interruption of supply of varying duration is tested. Examples for this occurrence may be short circuits, switching of loads, disconnecting of batteries and others.

This test applies to power consumers and not to power generators.

The waveform is as follows:

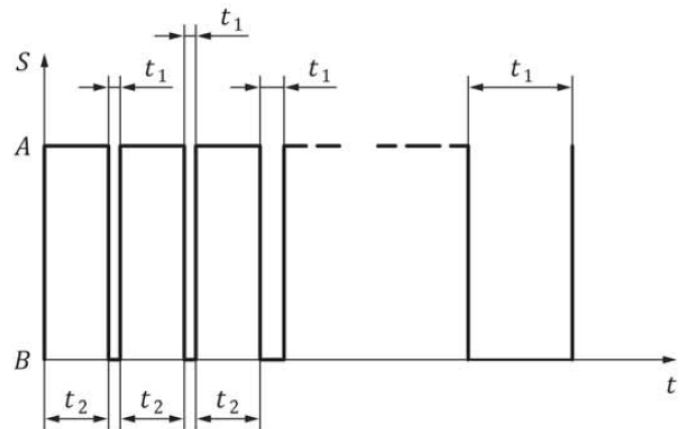
Key

- t time
 S S_1 switch control signal
 A switch closed
 B switch open

Operating mode	2.3 and 2.4	
R_i	$\leq 60 \text{ m}\Omega$ incl. switch S_1	
U_0	48 V	
t_1	The supply voltage of U_0 is interrupted for interval t_1 , which shall increase during the test in the following sequence:	
	Range of t_1	Increment in t_1 following each interruption
	$100 \mu\text{s} \leq t_1 < 1 \text{ ms}$	100 μs
	$1 \text{ ms} \leq t_1 < 10 \text{ ms}$	1 ms
	$10 \text{ ms} \leq t_1 < 100 \text{ ms}$	10 ms
	$100 \text{ ms} \leq t_1 < 2 \text{ s}$	100 ms
t_2	$\geq 10 \text{ s}$, until the DUT becomes 100 % operational according to specification	
switch reaction time	$\leq 10 \mu\text{s}$	

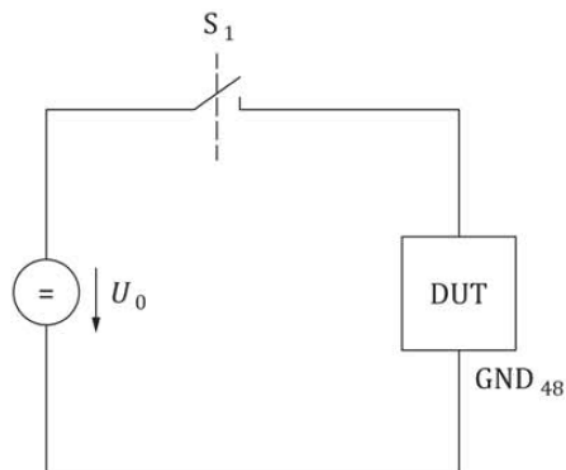
Key

S_1 switch on 48 V supply

How to Use

Take ISO21780 TEST-01 as an example to introduce how to use this function.

1. Press the composite keys **[Shift]+[I-set]** (Function) on the front panel to enter the function menu.
2. Use the knob or press the Up/Down key to select **3.Road-Vehicles = Off** and press **[Enter]**.
3. Use the knob or Left / Right key to select ISO21780, and press **[Enter]**.
4. Use the knob or Left / Right key to select **TEST-01**, and press **[Enter]**.

At this time, the lower right corner of the VFD screen displays the information of the recalled waveform: ISO21780-T01.

5. Press **[On/Off]** on the front panel to turn on the output.
6. According to the selected trigger method (same as the trigger method of the LIST function), for example, press **[Shift]+[On/Off]**(Trigger) to trigger the output of the waveform.

4.6.4 Solar Photovoltaic Curve Simulation Function (SAS)

The IT6000C series power supply provides the maximum power point tracking (MPPT) mechanism built-in, and it is very important to test the efficiency of this MPPT. The PV array/module/cell is a device that converts from light energy to electric energy. It is made by a simple semiconductor PN junction that the major output characteristic is that there's only one maximum power point (MPP) at certain sunlight intensity. The PV inverter is designed to track this point to harvest

maximum energy that is generated by the PV array. SAS function menu is as follows:

SAS	SAS function menu					
	Run	Indicates to enter the SAS function mode and wait for the trigger to run the currently selected PV curve file.				
	Static	Static PV curve setting.				
	Curve	Open or edit a fixed format PV curve.				
	Open	Select a fixed format PV curve.				
	Recall Inner Sas File	Set the name of the PV curve file and recall the PV file stored inside the instrument.				
	Edit	Edit a fixed format PV curve.				
	Pmp	Set the maximum power.				
	Vmp	Set the maximum power voltage.				
	Formula	Regulatory settings. The choice of solar panel materials under different regulations is different.				
		<table border="0"> <tr> <td>SANDIA</td> <td> <ul style="list-style-type: none"> • TF: Thin-Film • SCMC: Standard Crystalline or Multi-crystalline • HEC: High-efficiency Crystalline </td> </tr> <tr> <td>E-N50530</td> <td> <ul style="list-style-type: none"> • TF: Thin-Film • cSi </td> </tr> </table>	SANDIA	<ul style="list-style-type: none"> • TF: Thin-Film • SCMC: Standard Crystalline or Multi-crystalline • HEC: High-efficiency Crystalline 	E-N50530	<ul style="list-style-type: none"> • TF: Thin-Film • cSi
SANDIA	<ul style="list-style-type: none"> • TF: Thin-Film • SCMC: Standard Crystalline or Multi-crystalline • HEC: High-efficiency Crystalline 					
E-N50530	<ul style="list-style-type: none"> • TF: Thin-Film • cSi 					
	Save To	Set the saved file name. Parameter setting ranges from 1 to 100				
	User-defined	User-definable PV curves				

		Voc	Set the open-circuit voltage value.
		Imp	Set the maximum power current value.
		Vmp	Set the maximum power voltage value.
		Isc	Set the short-circuit current value.
	Table	Indicates a user-defined 4096-point I-V data table. This menu item is reserved and can only be used in PV SAS software sold separately. This function cannot be used in the VFD screen.	
	Filter	Filter the input voltage of the instrument to reduce interference.	
		Low	The filtering speed is low speed.
		Mid	The filtering speed is medium speed.
		Fast	The filtering speed is high speed.

Edit Static PV Curve

You can edit the static PV curve and save it inside the instrument (up to 100 curve records can be saved), or you can customize the editing of the PV curve (up to 1 can be saved).

- **Curve**

The steps to edit a static curve locally on the instrument are as follows:

1. Press the composite keys **[Shift]+[I-set]** (Function) on the front panel to enter the function menu.
2. Use knob or Up/Down key to select **4. SAS: Off** and press **[Enter]**.
3. Press the Left/Right key to select **Static** and press **[Enter]**.
4. Press the Left/Right key to select **Curve** and press **[Enter]**.
5. Press the Left/Right key to select **Edit** and press **[Enter]**.
6. Set the **Pmp**, **Vmp** and **Formula** in turns, and press **[Enter]**.
7. Set the saved file name and press **[Enter]**.
 - Also you can set the filter speed in **SAS**→**Filter** according to the actual test needs.

- After the above Curve parameters are set completely, you can press **[Esc]** until you return to the SAS main interface and select **Run** to trigger the current edited Curve file to run.

- **User-defined**

The steps to edit a custom curve are as follows:

1. Press the composite keys **[Shift]+[I-set]** (Function) on the front panel to enter the function menu.
2. Use knob or Up/Down key to select **4. SAS: Off** and press **[Enter]**.
3. Press the Left/Right key to select **Static** and press **[Enter]**.
4. Press the Left/Right key to select **User-defined** and press **[Enter]**.
5. Set the **Voc, Imp** and the other parameters, and press **[Enter]**.

After the setting is completed, the system returns to the main interface of the SAS function, and the currently edited custom curve is to be run. The interface is displayed as follows:

```
FUNCTION   SAS
Run  Vmax  Static  Table  Filter
```

Select Curve file

You can select the Curve file saved in the instrument to be in the Open state for later running.

1. Press the composite keys **[Shift]+[I-set]** (Function) on the front panel to enter the function menu.
2. Use knob or Up/Down key to select **4. SAS: Off** and press **[Enter]**.
3. Press the Left/Right key to select **Static** and press **[Enter]**.
4. Press the Left/Right key to select **Curve** and press **[Enter]**.
5. Press the Left/Right key to select **Open** and press **[Enter]**.
6. Set the name of the Curve file to be recalled (i.e. the file name set in **Edit**) and press **[Enter]**.

At this point, the system returns to the main interface of the SAS function, and the currently selected Curve file is to be run. The interface is displayed as follows:

```
FUNCTION   SAS
Run  Vmax  Static  Table  Filter
```

Run the Static PV Curve

- **Curve**

1. Refer to [Select Curve file](#) to select the Curve file to be run.

2. Set the **Vmax** (in **Config** menu) and **Filter** as the actual test needs.
3. Press the Left/Right key on the SAS main interface to select **Run** and press **[Enter]**.

At this point, the instrument enters the SAS mode, and the VFD screen is displayed as the main interface of the system, waiting to trigger the Curve file to run.

4. Turn on the **[On/Off]**.
5. Based on the selected trigger method, perform the trigger operation.

Note

The trigger method of the SAS function is consistent with the trigger method of the List function, that is, the List trigger source is also effective for the SAS function.

- **User-defined**

1. Refer to the **User-defined** related contents in the [Edit Static PV Curve](#) to finish editing the custom curve.
2. Set the **Vmax** (in **Config** menu) and **Filter** as the actual test needs.
3. Press the Left/Right key on the SAS main interface to select **Run** and press **[Enter]**.

At this point, the instrument enters the SAS mode, and the VFD screen is displayed as the main interface of the system, waiting to trigger the **User-defined** curve to run.

4. Turn on the **[On/Off]**.
5. Based on the selected trigger method, perform the trigger operation.

Note

The trigger method of the SAS function is consistent with the trigger method of the List function, that is, the List trigger source is also effective for the SAS function.

Stop Running the Static PV Curve

If you want to stop running during the SAS test, you can do the following: Press the composite keys **[Shift]+[I-set]** (Function) on the front panel to enter the function menu.

At this point, the interface will prompt whether to stop the running of the Function, you can press the Left/Right key to select **Stop**, then the running will be stopped, and the Function menu item will be displayed, you can re-enter the

Function menu for editing; if **Reset** is selected, it means to stop the present running and return to the main interface to wait for the next trigger operation.

4.6.5 Battery Simulation Function

The IT6000C series power supply can simulate battery characteristics in practical applications based on its unique bidirectional properties and the variable output impedance. You can set battery-related parameters to simulate the charge and discharge characteristics of the battery to assist with other tests. The menu items for this function are described below:

Battery Emulator	Battery simulation function		
	User-define	Select a user-defined battery simulation file for testing.	
	Run	Run the currently selected user-defined battery simulation file.	
		Initial Value	Set the initial state of charge (SOC) of the battery. 0~100% corresponds to the voltage range from no-load voltage to full-load voltage.
	Open	Open or select a user-defined battery emulation file.	
		Recall File	Set the file save address.
	Edit	Edit a user-defined battery simulation file.	
		Full Voltage	Simulates the voltage value when the cell battery is fully charged.
		Empty Voltage	Simulates the voltage value when the cell battery is in the empty state.

		Inner Resistance	Simulates the internal resistance of a cell battery.
		Capacity	Simulates the capacity of a cell battery.
		Parallel	Set the number of parallel connected batteries.
		Serial	Set the number of batteries in series.
		I+	Positive current limit value, which simulates the maximum discharge current of the battery pack.
		I-	Negative current limit value, which simulates the maximum charge current of the battery pack.
		Save To Group	Set the save address of the user-defined battery emulation file.
	Curve	Select the battery simulation curve file for testing.	
		Run	Run the currently selected battery simulation curve file.
		Initial Value	Set the initial state of charge (SOC) of the battery. 0~100% corresponds to the voltage range from no-load voltage to full-load voltage.
		Open	Open or select a battery simulation curve file.
		USB	Select the battery simulation curve file stored in the USB flash disk.

Edit Battery Simulation Test File

- **Edit user-defined battery simulation file**

1. Press the composite keys **[Shift]+[I-set]** (Function) on the front panel to enter the function menu.
2. Use knob or Up/Down key to select **5.Battery Emulator: Off** and press **[Enter]**.

The interface is displayed as follows:

```
FUNCTION BEMULATOR
User-define  Curve
```

3. Select the **User-define**→**Edit** and press **[Enter]**.
4. Set the parameters related to the user-defined battery simulation file and set the save address.

- **Edit battery simulation curve file**

1. Contact ITECH Technical Support to obtain a template for the battery simulation curve file (.csv format).
2. Use the Excel tool to open the template file, edit the relevant parameters, and save.

Run Battery Simulation File

After the battery simulation file is edited, you can select a file to run directly. After executing **Run**, you also need to set the initial state of charge (SOC), which is the ratio of the present battery's capacity divided by the full voltage capacity.

- **Run a user-defined battery simulation file**

1. Press the composite keys **[Shift]+[I-set]** (Function) on the front panel to enter the function menu.
2. Use knob or Up/Down key to select **5.Battery Emulator: Off** and press **[Enter]**.

The interface is displayed as follows:

```
FUNCTION BEMULATOR
User-define  Curve
```

3. Enter the **User-define**→**Open**, and set the **Recall File** to select the file to run, press **[Enter]**.
4. Press the Left/Right key to select **Run** and press **[Enter]**.
5. Set the **Initial Value** and press **[Enter]**.

The instrument will enter the battery simulation test mode and wait for the function to be triggered.

6. Turn on the **[On/Off]**.
7. Based on the selected trigger method, perform the trigger operation.

Note

The trigger method of the battery simulation is consistent with the trigger method of the List function, that is, the List trigger source is also effective for the Battery Emulator.

- **Run battery simulation curve file**

1. Save the edited battery simulation curve file to the root directory of the USB flash disc.
2. Insert the USB flash disc into the USB interface on the front panel of the instrument.
3. Press the composite keys **[Shift]+[I-set]** (Function) on the front panel to enter the function menu.
4. Use knob or Up/Down key to select **5.Battery Emulator: Off** and press **[Enter]**.

The interface is displayed as follows:

```
FUNCTION BEMULATOR
User-define  Curve
```

5. Enter the **Curve**→**Open**→**USB**, select the file to run and press **[Enter]**.
6. Press the Left/Right key to select **Run** and press **[Enter]**.
7. Set the **Initial Value** and press **[Enter]**.

The instrument will enter the battery simulation test mode and wait for the function to be triggered.

8. Turn on the **[On/Off]**.
9. Based on the selected trigger method, perform the trigger operation.

Note

The trigger method of the battery simulation is consistent with the trigger method of the List function, that is, the List trigger source is also effective for the Battery Emulator.

After the battery simulation is triggered, the VFD screen displays as follows:

```
12.000V          2.000A
12.0Ah           12.5%SOC
```

- The first line shows the voltage and current Meter values in real time.

- The second line shows the present battery capacity and the actual state of charge (SOC).

Stop Battery Simulation Test

As the battery simulation test runs, the SOC value is constantly changing:

- When the SOC rises (simulated charge), the voltage will also rise. When the voltage reaches full voltage (**Full Voltage**), the voltage will continue to rise.

If you want to stop testing when the voltage reaches full voltage, turn on the OVP function and set the OVP level to the full voltage value. See [4.5.1 Set Over-Voltage Protection \(OVP\)](#) for details.

- When the SOC drops (simulated discharge), the voltage will also drop. When the voltage reaches empty voltage (**Empty Voltage**), the voltage will continue to drop.

If you want to stop testing when the voltage reaches empty voltage, turn on the UVP function and set the UVP level to the empty voltage value. See [4.5.5 Set Under-Voltage Protection \(UVP\)](#) for details.

If you want to stop running during the battery simulation test, you can do the following: Press the composite keys **[Shift]+[I-set]** (Function) on the front panel to enter the function menu.

At this point, the interface will prompt whether to stop the running of the Function, you can press the Left/Right key to select **Stop**, then the running will be stopped, and the Function menu item will be displayed, you can re-enter the Function menu for editing; if **Reset** is selected, it means to stop the present running and return to the main interface to wait for the next trigger operation.

5 Basic Operation

This chapter describes the basic functions and features of the instrument. Divided into the following sections:

- ◆ Local/Remote Mode Switch
- ◆ Key Lock Function
- ◆ Save and Recall Operations
- ◆ Data Logging Function
- ◆ Set the Beeper Status (Beep)
- ◆ Set the Power-on State (PowerOn)
- ◆ Sense Function (Sense)
- ◆ Select Trigger Source (Trig Source)
- ◆ Set the Communication Information (I/O Con)
- ◆ Set Parallel Operation Mode (Parallel)
- ◆ Digital I/O Function (Digital Port)
- ◆ Analogue Function (Ext-Program) (Optional)
- ◆ Restored to Factory Setting (System Reset)
- ◆ View the System Information (System Info)
- ◆ System Upgrade

5.1 Local/Remote Mode Switch

The power supply provides both local and remote operation modes. The default mode of the power supply is local operation mode.

- Local operation mode: Use the front panel keys to control the power supply.
- Remote operation mode: The power supply is connected to PC, and the user uses the software in PC to control the power supply remotely.
 - During remote control operation, the remote symbol “Rmt” is displayed. All panel keys, except the **[On/Off]** and **[Shift]+[3]** (Local) keys, are locked.
 - You can press **[Shift]+[3]** (Local) to switch the remote control to local control. The mode modification will not affect the output parameters of the power supply.

5.2 Key Lock Function

This function can prevent the power supply from the panel keys misoperation during usage. Press the composite keys **[Shift]+[2]** (Lock) to lock front panel keys and the lock symbol “*” is shown on the front panel display. All panel keys,

except the **[On/Off]** and **[Shift]+[2]** (Lock) keys, are locked. You can repress **[Shift]+[2]** (Lock) to unlock the front panel.

5.3 Save and Recall Operations

The power supply can save up to 10 common parameters in nonvolatile memory (No. 1 to No. 10) for user to recall conveniently. The saved settings include the following parameters.

Category	Parameter
Main interface	Voltage setting: Vs
	Current setting: Is
	Upper limit of voltage: Vh, and lower limit of voltage: Vl
	Upper limit of current: I+, and lower limit of current: I-
	Upper limit of power: P+, and lower limit of power: P-
	The output status of the instrument: [On/Off]
Config menu	CC/CV loop priority mode: Mode
	CC/CV loop speed: Speed
	Voltage/Current rise time: V-Rise Time/I-Rise Time
	Voltage/Current fall time: V-Fall Time/I-Fall Time
	On/Off switch delay: On Delay/Off Delay
	Internal resistance of the power supply: Output Res
Protect menu	OCP/OVP/OPP/UCP/UVP switch status: On/Off
	OCP/OVP/OPP/UCP/UVP limit setting: Level
	OCP/OVP/OPP/UCP/UVP delay time: Delay
	UCP/UVP warm-up time: Warm-up

You can do the save and recall operations by the following two methods.

- Press the composite keys **[Shift]+[+/-]** (Save) to save the parameters. Press the **[Recall]** key to recall the parameters.
- SCPI commands: ***SAV** and ***RCL**

5.3.1 Save Operation

The save operation procedures are as follows:

1. Press the composite keys **[Shift]+[+/-]** (Save) to enter the parameter save interface.
2. Set the storage location.
Enter a number in the "Save data to bank=1" to set the storage location in non-volatile memory.
3. Press **[Enter]** to save the parameters.

5.3.2 Recall Operation

You can recall the parameters you saved in the specified memory location as the setting values.

1. Press the **[Recall]** key to enter the parameter recall interface.
2. Set the storage location.
Enter a number in the "Recall data from bank=1" to set the storage location in non-volatile memory.
3. Press **[Enter]** to recall the parameters.

5.4 Data Logging Function

The IT6000C series Bi-directional Programmable DC Power Supply supports the recording and saving of test data. This Chapter introduces how to use this function in details.

The user can select the following data sources for recording:

- Voltage
Only records voltage data during the data acquisition period.
- Current
Only records current data during the data acquisition period.
- Voltage and current
Records current and voltage data during the data acquisition period.

Configure the Function Menu

1. Press the composite button **[Shift]+[1]** (Log) on the front panel to enter the configuration menu of the data logging function.

The parameters are described as follows:

Menu Item	Description	Setting
Sample Period	<p>This parameter indicates the data sampling interval (unit: s), that is, the test data is recorded once every X seconds.</p> <p>The input range supported by the instrument is: 0.001-100s</p>	Set the value by inputting the value through the number key or rotating the knob.
Duration	<p>This parameter indicates the time for data recording (unit: s), namely, the data recording will be completed in Y seconds and be ready for the next data record.</p> <p>The input range supported by the instrument is: 0-50000000s</p>	
Source	<p>This parameter indicates the source of recorded data, including voltage (V), current (I), voltage and current (V/I).</p>	Use the Left and Right arrow key or the rotation knob to select.
Data Type	<p>This parameter indicates the type of recorded data, including:</p> <ul style="list-style-type: none"> • Aver: This is the default selected data type, namely, the average of all data acquired in the data recording period as indicated in the table of saved data. • Aver+Max+Min: If this option is selected, it means the average value, maximum value and minimum value of data acquired in the data recording period as indicated in the data saving table. 	

2. Set the value of **Sample Period** and press **[Enter]**.
3. Set the value of **Duration** and press **[Enter]**.

4. Set the value of **Source** and press **[Enter]**.
5. Set the value of **Data Type** and press **[Enter]**.

Select the Trigger Method

See the steps in the [5.8 Select Trigger Source \(Trig Source\)](#) section to set how the data logging is triggered.



Note

This setting result is only valid for data recording function. When List function is used, the method for triggering the running of List files needs to be additionally set (by default, triggered by the panel).

Start Data Logging

CAUTION

- **Before this operation, make sure to connect the USB memory device to the memory port on the front panel (The USB interface on the rear panel can only be used for connecting the PC) so that the recorded data can be stored in the external storage device. Otherwise, the Data Recording function is not available for usage.**
- **Do not connect the USB communication interface on the rear panel to the PC, otherwise the Data Recording function will be unavailable. If you need a communication connection with a PC, use a communication interface other than USB, such as LAN.**

- **Trigger immediately**

Perform a trigger operation immediately.

- **Manual**

Press the composite button **[Shift] + [On/Off]** (Trigger) on the front panel to trigger.

- **Bus**

Triggered by the SCPI instruction, for example, when the instrument receives the trigger command ***TRG**, a trigger operation is performed.

- **Voltage trigger**

When the DC terminals detect that the voltage reaches the trigger voltage setting value and is within the range of the upper and lower trigger limits, a data recording operation is triggered.

- Level: Trigger threshold.
- Up-Level: Trigger upper limit value.
- Down-Level: Trigger lower limit value.
- **Current trigger**

When the DC terminals detect that the current reaches the trigger current setting value and is within the range of the upper and lower trigger limits, a data recording operation is triggered.

 - Level: Trigger threshold.
 - Up-Level: Trigger upper limit value.
 - Down-Level: Trigger lower limit value.
- **External**

Connect to pin 4 of the digital I/O interface (P-IO) and set pin 4 to **Ext-Trig**→**Trig-In**→**Dlog** to trigger.

For details, see [5.11.4 IO-4. Ext-Trig, Not-Invert.](#)

After the data recording function is started, the recorded data is saved in USB memory device in .csv format. The user can get access to these files for analysis based on needs.

5.5 Set the Beeper Status (Beep)

The user can turn the instrument beeper sound on or off base on personal requirement.

The beeper sound works in the following scenarios:

- A beeper sound produced when the front panel key is pressed.
- When an error is generated inside the instrument, such as when the instrument receives an unprocessable command in the remote state. At this time, the instrument produces a beeper sound, and the flag “Error” appears on the VFD.
- When the instrument is under protection status, such as over-temperature protection. At this time, the instrument produces the beeper sound.

The setting procedures are as follows:

1. Press the composite keys **[Shift]+[P-set]** (System) on the front panel to enter the system menu.

The first displayed menu item **Beep** is used to set the beeper status.

2. Press **[Enter]** key to enter the parameter setting interface.

3. Press the Left / Right key or turn the knob to adjust the value of this parameter.
 - On: Default value, indicates the beeper is on.
 - Off: Indicates the beeper is off.
4. After the parameter settings are complete, press **[Enter]**.
At this point, the beeper status takes effect immediately.

5.6 Set the Power-on State (PowerOn)

This menu item is used to control the settings and output state when the power supply is powered on.

The detailed power-on parameters and output state are as follows.

- The voltage, current, power setting values displayed on the main interface when the instrument is powered on.
- Parameter setting values in the **Config** menu.
- The output state of the power supply, i.e., the **[On/Off]** key state.

The procedures to set the menu item are as follows.

1. Press the composite keys **[Shift]+[P-set]** (System) on the front panel to enter the system menu.
2. Press the Up/Down key or turn the knob to select the **PowerOn** and press **[Enter]**.
3. Press the Left / Right key or turn the knob to adjust the value of this parameter.
 - Reset: Default value, indicates when the instrument is powered on, the instrument will initialize some parameter settings or state.

The affected parameters and the reset information are as shown in the following table.

Table 5–1 Initial value of the parameter

Category	Parameter	Initial Value
Main interface	Voltage setting: Vs	One percent of the rated voltage of the instrument
	Current setting: Is	One percent of the rated current of the instrument

Category	Parameter	Initial Value
	Upper limit of voltage: V_h , and lower limit of voltage: V_l	Upper limit value: One percent of the rated voltage of the instrument Lower limit value: 0
	Upper limit of current: I_+ , and lower limit of current: I_-	One percent of the rated current of the instrument
	Upper limit of power: P_+ , and lower limit of power: P_-	Rated power value of the instrument
	[On/Off] status	Off
Config menu	Mode	CV
	Speed	High
	V-Rise Time/I-Rise Time	0.1s
	V-Fall Time/I-Fall Time	
	Output Res	0
	On Delay/Off Delay	0

- Last: Indicates when powered on, the instrument will remain the same parameter settings and output status as last time you powered off the instrument.
 - Last+Off: Indicates when powered on, the instrument will remain the same settings as last time you powered off the instrument, but the output status is **Off**.
4. After the parameter settings are complete, press **[Enter]**.

For example, **Last** is selected, and the voltage value is set to 20V. After the instrument is powered off and then powered on, the voltage displayed on the interface is 20V.

5.7 Sense Function (Sense)

This menu item is used to switch the power supply to local measurement or remote sensing.

The IT6000C series power supply supports two connection methods: Local measurement and Remote sensing. The remote sensing is used for maximizing measurement accuracy. (Refer to [2.5 Connecting the Device Under Test \(DUT\)](#))

The procedures to set the menu item are as follows.

1. Press the composite keys **[Shift]+[P-set]** (System) on the front panel to enter the system menu.
2. Press the Up/Down key or turn the knob to select the **Sense** and press **[Enter]**.
3. Press the Left / Right key or turn the knob to adjust the value of this parameter.
 - Off: Default value, indicates turn the sense function off.
 - On: Indicates turn the sense function on.
4. After the parameter settings are complete, press **[Enter]**.

5.8 Select Trigger Source (Trig Source)

For the IT6000C series power supply, the List and data logging functions can be triggered for running by the following methods:

- Immediate: Perform a trigger operation immediately.
- Manual: Default value, indicates the trigger occurs when the **[Shift]+[On/Off]** (Trigger) keys are pressed from the front panel.
- Bus: Indicates the trigger occurs via the communication cables. When the trigger command ***TRG** is received, the IT6000C instrument generates a trigger.
- Voltage (only available in DLogTrig Source): Voltage trigger.

When the DC terminals detect that the voltage reaches the trigger voltage setting value and is within the range of the upper and lower trigger limits, a data recording operation is triggered.

- Level: Trigger threshold.
- Up-Level: Trigger upper limit value.
- Down-Level: Trigger lower limit value.

- Current (only available in DLogTrig Source): Current trigger.

When the DC terminals detect that the current reaches the trigger current setting value and is within the range of the upper and lower trigger limits, a data recording operation is triggered.

- Level: Trigger threshold.
- Up-Level: Trigger upper limit value.
- Down-Level: Trigger lower limit value.
- External: Indicates the trigger occurs via the pin 4 of the digital I/O interface (P-IO).

For details, see [5.11.4 IO–4. Ext-Trig, Not-Invert](#).

The List function and the data logging function have the same steps for selecting the trigger source. They need to be set separately in different menu items (**ListTrig Source** and **DLogTrig Source**). Therefore, this section takes the List trigger source setting as an example to introduce the operation steps.

1. Press the composite keys **[Shift]+[P-set]** (System) on the front panel to enter the system menu.
2. Press the Up/Down key or turn the knob to select the **ListTrig Source** and press **[Enter]**.



Note

- When setting the trigger source for data logging, select the **DLogTrig Source** menu item.
 - The List trigger source set here is also valid for triggering other functions in the **Function** menu.
3. Press the Left / Right key or turn the knob to adjust the value of this parameter.
 4. After the parameter settings are complete, press **[Enter]**.

5.9 Set the Communication Information (I/O Con)

This menu item is used to set the communication information between instrument and PC. The standard communication interfaces for IT6000C series power supply are USB, LAN, CAN and VCP. You can also select the non-standard interface GPIB or RS-232 based on personal requirement.

The procedures to set the menu item are as follows.

1. Press the composite keys **[Shift]+[P-set]** (System) on the front panel to enter the system menu.
2. Press the Up/Down key or turn the knob to select the **I/O** and press **[Enter]**.
3. Press the Left / Right key or turn the knob to adjust the value of this parameter.

4. After the parameter settings are complete, press **[Enter]**.

Note

- The default communication method is USB. If other communication method is selected, the related parameters need to be set. For detailed parameter description, refer to [2.6 Remote Interface Connection](#).
- The instrument supports the non-standard RS-232 and GPIB interfaces, and the configuration items in the menu are dynamically displayed according to the interface user selected.

5.10 Set Parallel Operation Mode (Parallel)

This menu item is used to control whether the instrument is working in single mode or in parallel mode. This chapter takes three instruments (with operation panel) as an example to describe how to parallelize the single units and how to return from parallel mode to single mode.

The IT6000C series power supply supports multiple instruments to work in parallel mode to provide more power and current output capability.

Configure the Menu Item

1. Press the composite keys **[Shift]+[P-set]** (System) on the front panel to enter the system menu.
2. Press the Up/Down key or turn the knob to select the **Parallel** and press **[Enter]**.
3. Press the Left / Right key or turn the knob to adjust the value of this parameter.
 - Single: Default value, indicates that the instrument is in single mode.
 - Master: Indicates that the current single unit is set to master in parallel mode. When set to **Master**, you also need to set the number of slaves to be mounted for the master, so you need to set the value of the **Total** parameter. For example, setting **Total = 3** means that the total number of units in the parallel relationship is 3.

Note

In the parallel mode, you only need to operate the master. Synchronous operations on other slaves are implemented by operating the master.

- Slave: Indicates that the instrument is set to the slave in parallel mode.

4. After the parameter settings are complete, press **[Enter]**.

Set the Parallel Mode

CAUTION

- **Before connecting the fiber optic, you must ensure that each instrument is in single mode (Single).**
- **Parallel connection is only supported between instruments/cabinets that meet the following two conditions:**
 1. **The 3U single unit is the same model or the 3U single units in all the cabinets are the same model.**
 2. **The firmware version is the same. (Go to System > System information > Main Version menu to check)**
- **Fiber optic cables cannot be flexed or folded. When the cable is too long and needs to be arranged, gently wrap the cable in a circle and gently tie it.**

WARNING

- **Before connecting the cables, ensure that the instrument power switch is off and the main switch of the AC power input (distribution box) is off.**
- **Before connecting 3 single instruments to the AC distribution box, ensure that the distribution box capacity is sufficient. Refer to the corresponding specifications for the AC input parameters of a single instrument.**

For 3U models, up to 16 units of the same model can be connected in parallel. Taking three 3U single instruments (with operation panel) as an example, the steps for parallel operation are as follows.



Note

For a parallel connection between a master unit (with operation panel) and N slave units (without operation panel), refer to the *IT6000 Parallel Assembly Instruction* or the *IT6000 Cabinet Assembly Instruction*.

1. Ensure that the power switches of the three units and the main switch of the AC power distribution box are off.
2. Refer [Figure 5–1 Wiring connection diagram](#) to connect three units.

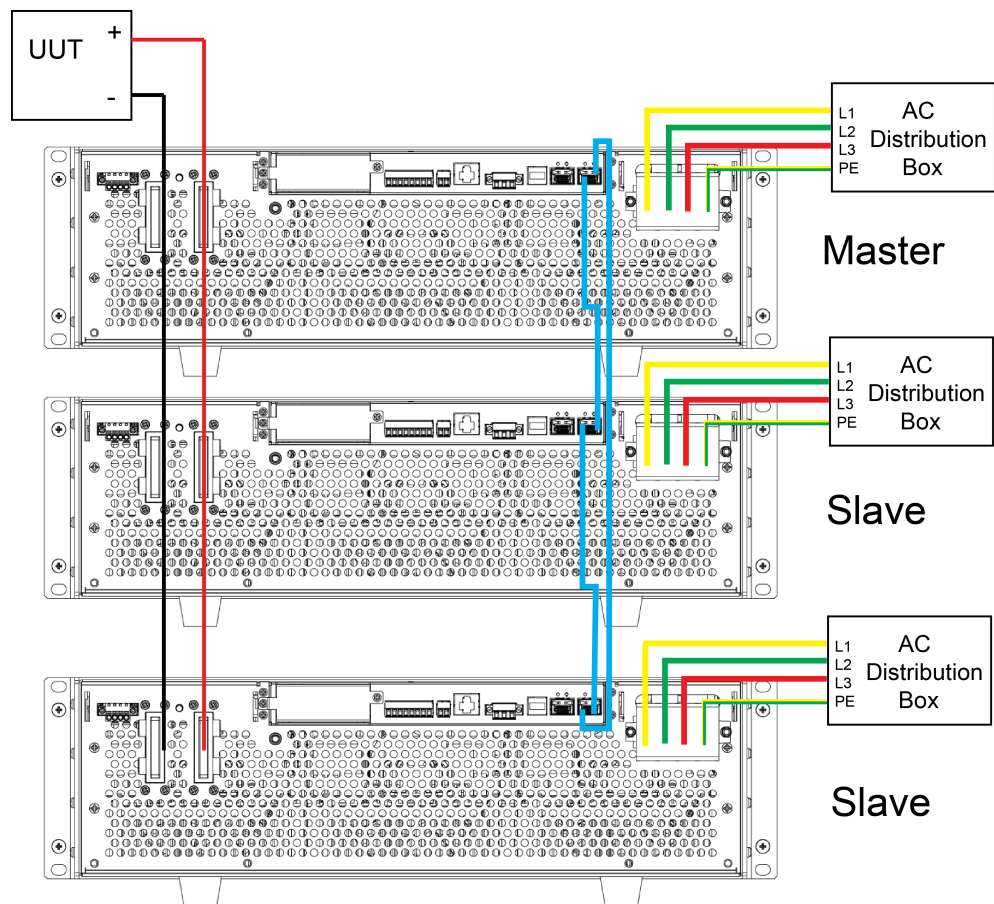
Figure 5–1 Wiring connection diagram

- Connect the AC input terminals of the three units separately, and connect them to the AC distribution box.
- Connect the DC output terminals of the three units in parallel and connect them to the DUT.
- Refer to the blue wiring legend in the figure, connect the fiber optic (i.e., the fiber outer ring interfaces TX and RX) for fiber-optic communication between the master and slaves.
 - Three 3U single instruments parallel

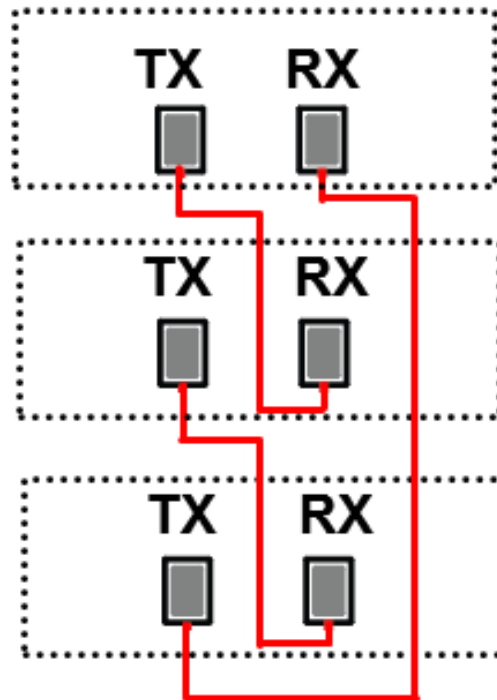

- Two cabinets parallel

The wiring rules for the fiber interface are shown in the figure below. Black indicates the wiring of the inner ring of the fiber, and red indicates the wiring of the outer ring of the fiber.

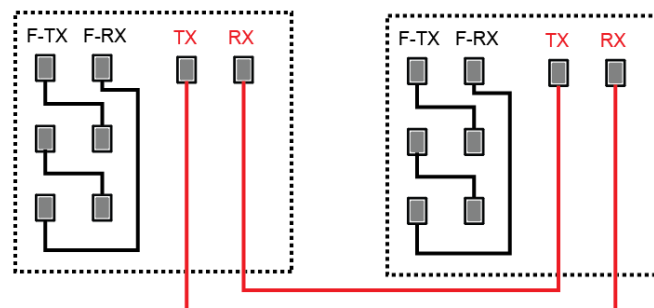

3. Turn on the main switch of the AC distribution box and power on each of the three units.
4. Set three units in parallel mode with one master and two slaves.
 - a. Press the composite keys **[Shift]+[P-set]** (System) on the front panel to enter the system menu.
 - b. Set **Parallel** to **Master** or **Slave** and press **[Enter]**.
 - c. After setting the **Master**, you need to set **Total** to 3.

For details, see [Configure the Menu Item](#).
5. After the parallel menu of the three units are set, restart the instrument separately.

After the instrument is restarted, the VFD shows that the instrument is working in parallel mode.

Revert to Single Mode

1. Set each of the three instruments to single mode.
 - a. Press the composite keys **[Shift]+[P-set]** (System) on the front panel to enter the system menu.
 - b. Set the **Parallel** to **Single**.

For details, see [Configure the Menu Item](#).
2. Power off the three instruments and turn off the main switch of the AC distribution box.
3. Remove the cables connection of the fiber optic and DC output terminals between three units.
4. Power on the three instruments separately.

After the instrument is restarted, the VFD shows that the instrument is working in single mode.

5.11 Digital I/O Function (Digital Port)

The IT6000C series power supply supports digital I/O function. The user can realize logic control over high and low level input or output by related configurations in the system menu, namely general digital signal I/O function. In addition to general digital I/O functions, this series can be customized to meet different special needs through different pin wirings. For example, you can connect a pin to an external instrument, and set a fixed pulse or level signal for the external instrument. Once the external instrument fails, output this pulse or level signal. After the instrument identifies this signal, it controls whether the power supply output is reduced to 0 or whether the **[On/Off]** is switched off based on related settings.

The rear panel of the instrument has a green 8-pin terminal. The terminal is a wiring terminal with digital I/O function. These pins are bi-directional I/O interfaces. For hardware index information, see [Table 5–2 Hardware parameters of the I/O interface](#). The pins support the input or output of pulse and high and low level. Different pins can achieve different functions.

Table 5–2 Hardware parameters of the I/O interface

Input voltage range	-5V to +15V
Maximum low level output voltage	0.65V
Maximum low level input voltage	0.8V

Minimum high level input voltage	1.6V
Typical high level output voltage	5V
Typical low level output voltage	0V
Level rise slope	10us
Level fall slope	2us

Note

The maximum sink current of each pin is 100mA, and the maximum output current is 1mA.

Pins Introduction

The appearance of the terminals are shown below.

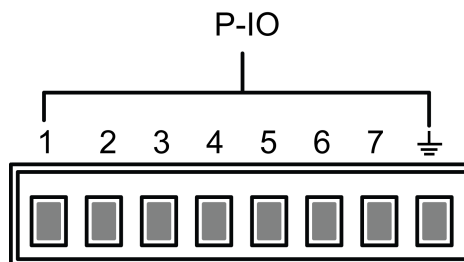

Pin	Description	Properties (Default function)	Properties (General I/O function)
1	Corresponds to the function set in the System→Digital Port→IO-1. Ps-Clear, Not-Invert menu item. For parameter introduction, see 5.11.1 IO-1. Ps-Clear, Not-Invert .	Pulse signal	Level or PWM signal
2	Corresponds to the function set in the System→Digital Port→IO-2. Ps, Not-Invert menu item. For parameter introduction, see 5.11.2 IO-2. Ps, Not-Invert .	Level signal	Level or PWM signal
3	Corresponds to the function set in the System→Digital Port→IO-3. Off-	Level signal	Level or PWM signal

Pin	Description	Properties (Default function)	Properties (General I/O function)
	Status, Not-Invert menu item. For parameter introduction, see 5.11.3 IO-3. Off-Status, Not-Invert .		
4	Corresponds to the function set in the System→Digital Port→IO-4. Ext-Trig, Not-Invert menu item. For parameter introduction, see 5.11.4 IO-4. Ext-Trig, Not-Invert .	Pulse signal	Level or PWM signal
5	Corresponds to the function set in the System→Digital Port→IO-5. INH-Living, Not-Invert menu item. For parameter introduction, see 5.11.5 IO-5. INH-Living, Not-Invert .	Pulse signal	Level or PWM signal
6	Corresponds to the function set in the System→Digital Port→IO-6. Sync-On, Not-Invert menu item. For parameter introduction, see 5.11.6 IO-6. Sync-On, Not-Invert .	Pulse signal	Level or PWM signal
7	Corresponds to the function set in the System→Digital Port→IO-7. Sync-Off, Not-Invert menu item. For parameter introduction, see 5.11.7 IO-7. Sync-Off, Not-Invert .	Pulse signal	Level or PWM signal
GND	Ground terminal, that is, the negative terminal corresponding to each of the above 7 pins.	Level signal	



Note

In this chapter, all the pulse signals involved in the digital I/O function are switched from high level to low level.

Taking pin 1 as an example, **IO-1. Ps-Clear, Not-Invert** contains three function options, the first option **Ps-Clear** is the default function, and this function is also a special custom function unique to this pin (the seven pins each have a different custom function). The second and third options (**Input** and **Output**) are the general digital I/O function, and the parameter settings and functions of the seven pins are the same.

General Digital I/O Function

- Under the default condition (**Not-Invert**), when the pin (1 to 7) is configured as **Output**, it can output the high level (False) or low level (True).

Note

If the corresponding pin is configured as **Invert**, it means that the digital signal is inverted and will output low level or high level.

- Under the default condition (**Not-Invert**), when the pin (1 to 7) is configured as **Output**→**PWM**, the user needs to set the frequency (**PWM Freq**) and duty cycle (**PWM Duty**) values. For example, if the **PWM Freq** is set to 100Hz and the **PWM Duty** is set to 10%, the output waveform is as follows:

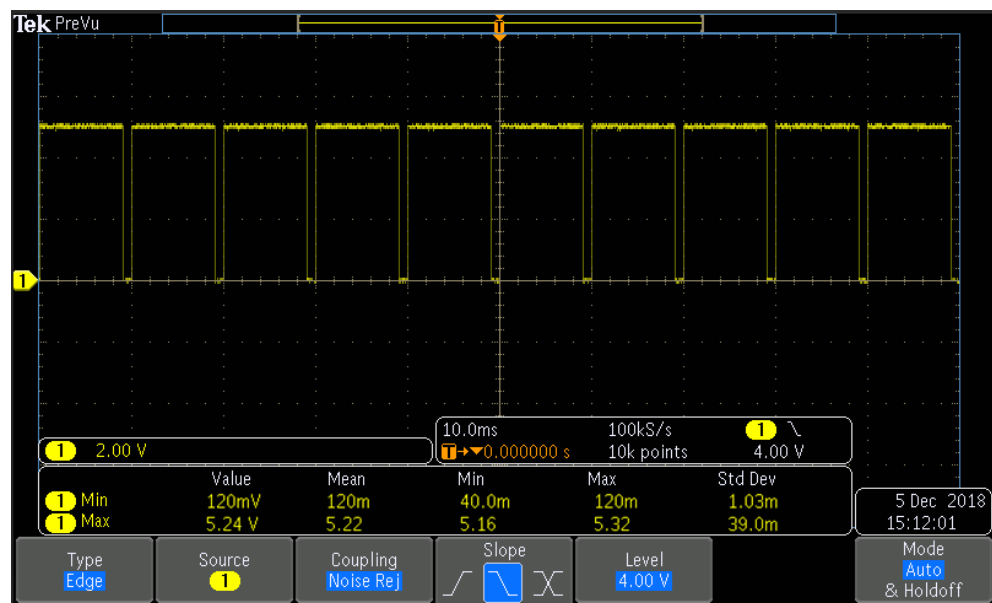

Note

In the above figure, the peak voltage (minimum value) is 5.16V and the cycle is 10ms. The high level duration is 9ms and the low level duration is 1ms in one cycle.

- Under the default condition (**Not-Invert**), when the pin (1 to 7) is configured as **Input**, it means the instrument can detect the level status of the external input. By default (i.e., the pin is not connected), it can be detected as high level, and the front panel will display input(1). If the pin is configured as **Invert**, it can be detected as low level, and the front panel will display input (0).

5.11.1 IO-1. Ps-Clear, Not-Invert

Parameter Description

IO-1. Ps-Clear, Not-Invert	Parameter setting for pin 1.			
	Not-Invert	Indicates whether to invert the input/output pulse or level signal.		
	Invert	<ul style="list-style-type: none"> • Invert: Yes • Not-Invert: No 		
	Ps-Clear	This default function means that when the instrument generates protection, the protection state can be cleared via this pin.		
	Input	Pin 1 receives the level signal from the outside.		
	Output	Pin 1 sends the digital signal (1, 0, PWM) to the outside.		
		True	By default (Not-Invert), the output digital signal is 1 (i.e. low level), and in the case of Invert , the output is high level.	
		False	By default (Not-Invert), the output digital signal is 0 (i.e. high level), and in the case of Invert , the output is low level.	
		PWM	Digital signal of PWM.	
			PWM Freq	Frequency
			PWM Duty	Duty cycle

How to Use

When pin 1 is set to default **Ps-Clear** function, pin 1 has bi-directional I/O function, which can receive pulse signal input from the external instrument and also can output pulse signal to external instrument. Pulse signal parameter requirements are as follows:

Level rise slope	10us
Level fall slope	2us
Minimum time width for low level keep	30us

- Pulse input: When the instrument is under protection, the instrument will clear protection after receiving the pulse signal from external input.
 1. Refer to the figure below to connect pin 1 to the external oscilloscope.

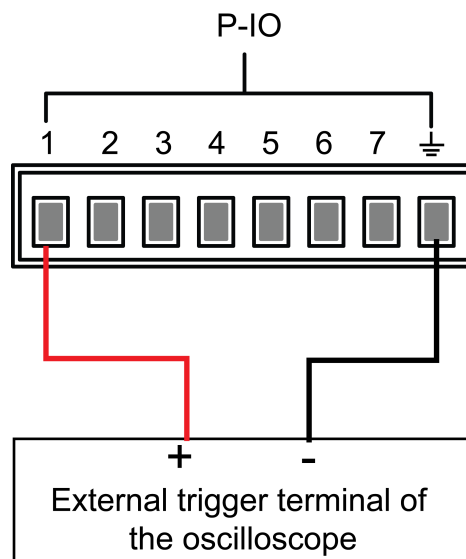

2. Confirm that pin 1 function is set to the default option, namely **IO-1. Ps-Clear, Not-Invert**.
 3. Taking OCP as an example, set the protection point of OCP.
 4. Build the test environment to enable the instrument to enter the OCP state.
 5. Send pulse signal to pin 1.
 6. Check whether the protection state of this instrument is cleared.
- Pulse output: When the instrument's protection state is released, and **[On/Off]** is from Off to On, pin 1 will send a pulse signal to the external instrument.
 1. Clear the instrument's OCP protection.
 2. Check the oscilloscope and confirm whether pin 1 has pulse output.

5.11.2 IO-2. Ps, Not-Invert

Parameter Description

IO-2. Ps, Not-Invert	Parameter setting for pin 2.			
	Not-Invert	Indicates whether to invert the input/output pulse or level signal.		
	Invert	<ul style="list-style-type: none"> • Invert: Yes • Not-Invert: No 		
	Ps	This default function means the output level from pin 2, which displays that whether the instrument is under protection or not.		
	Input	Pin 2 receives the level signal from the outside.		
	Output	Pin 2 sends the digital signal (1, 0, PWM) to the outside.		
	True	By default (Not-Invert), the output digital signal is 1 (i.e. low level), and in the case of Invert , the output is high level.		
	False	By default (Not-Invert), the output digital signal is 0 (i.e. high level), and in the case of Invert , the output is low level.		
	PWM	Digital signal of PWM.		
		PWM Freq	Frequency	
	PWM Duty	Duty cycle		

How to Use

When pin 2 is set to default **Ps** function, pin 2 will output high or low level based on whether the instrument is under protection or not. Under normal conditions (Not under protection), and when pin 2 is under default setting (**Not-Invert**), pin

2 outputs high level; when the instrument is under protection, pin 2 outputs low level.



Note

When pin 2 is set to **Invert**, the output level is completely opposite.

1. Refer to the figure below to connect pin 2 to the external oscilloscope.

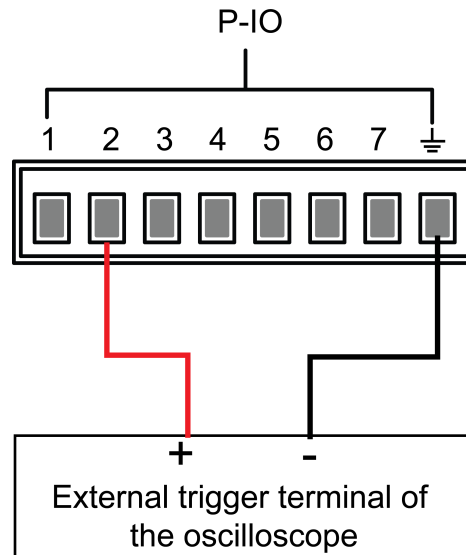

2. Confirm that pin 2 function is set to the default option, namely **IO-2. Ps, Not-Invert**.
3. Taking OCP as an example, set the protection point of OCP.
4. Build the test environment to enable the instrument to enter the OCP state.
5. Check the oscilloscope and confirm that pin 2 outputs low level.

5.11.3 IO-3. Off-Status, Not-Invert

Parameter Description

IO-3. Off-Status, Not-Invert	Parameter setting for pin 3.	
	Not-Invert	Indicates whether to invert the input/output pulse or level signal.
	Invert	<ul style="list-style-type: none"> • Invert: Yes • Not-Invert: No
	Off-Status	This default function indicates the existing [On/Off] state of the instrument.

		Input	Pin 3 receives the level signal from the outside.	
		Output	Pin 3 sends the digital signal (1, 0, PWM) to the outside.	
		True	By default (Not-Invert), the output digital signal is 1 (i.e. low level), and in the case of Invert , the output is high level.	
			By default (Not-Invert), the output digital signal is 0 (i.e. high level), and in the case of Invert , the output is low level.	
		PWM	Digital signal of PWM.	
			PWM Freq	Frequency
			PWM Duty	Duty cycle

How to Use

When pin 3 is set to default **Off-Status** function, pin 3 will trigger level output based on the **[On/Off]** state of the instrument. When it is set to (**Not-Invert**), the **[On/Off]** is turned off, and pin 3 outputs high level; the **[On/Off]** is turned on, and pin 3 outputs low level.



Note

When pin 3 is set to **Invert**, the output level is completely opposite.

1. Refer to the figure below to connect pin 3 to the external oscilloscope.

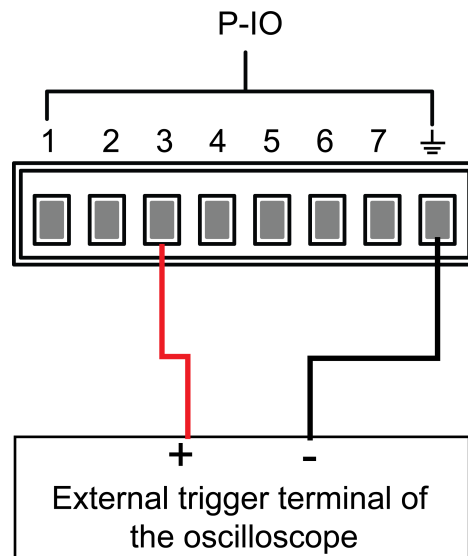

2. Confirm that pin 3 function is set to the default option, namely **IO-3. Off-Status, Not-Invert**.
3. Turn on [On/Off].
4. Check the oscilloscope and confirm that pin 3 outputs low level.

5.11.4 IO-4. Ext-Trig, Not-Invert

Parameter Description

IO-4. Ext-Trig, Not-Invert	Parameter setting for pin 4.		
	Not-Invert	Indicates whether to invert the input/output pulse or level signal.	
	Invert	<ul style="list-style-type: none"> • Invert: Yes • Not-Invert: No 	
		Ext-Trig	This default function means that pin 4 of the P-IO performs bi-direction control over the instrument's trigger function.
		Trig-Out	Indicates that when the instrument generates a signal (which triggers the Meter function, Data Recording function and List function for running), pin 4 will output a pulse signal.

			Trig-In	Indicates that the instrument will trigger the running of one of the functions below after receiving the external pulse signal.	
				Meter	Triggers the running of Meter function. This function needs to be triggered at the upper computer side through SCPI instruction. For details, refer to instructions related to ACQUIRE in the Trigger subsystem of the Instruction Manual.
				Dlog	Triggers the running of data recording function.
				List	Triggers the running of List files.
		Input	Pin 4 receives the level signal from the outside.		
		Output	Pin 4 sends the digital signal (1, 0, PWM) to the outside.		
			True	By default (Not-Invert), the output digital signal is 1 (i.e. low level), and in the case of Invert , the output is high level.	
			False	By default (Not-Invert), the output digital signal is 0 (i.e. high level), and in the case of Invert , the output is low level.	
			PWM	Digital signal of PWM.	
				PWM Freq	Frequency

				PWM Duty	Duty cycle
--	--	--	--	----------	------------

How to Use

Taking the triggering of List function as an example, the text below will introduce how to use pin 4's default function **Ext-Trig**.

- Trig-Out

1. Refer to the figure below to connect pin 4 to the external oscilloscope.

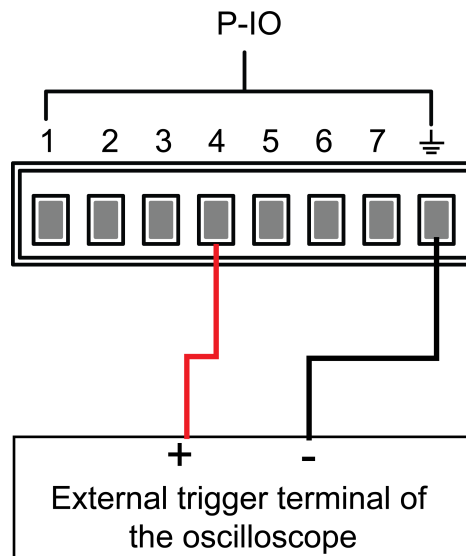

2. Set pin 4's function to **Not-Invert** and **Trig-Out**.
3. Recall the edited List file for trigger running.
4. Press **[Shift]+[On/Off]** (Trigger) on the front panel to trigger the running of List files.



Note

ListTrig Source is set to **Manual**.

5. Check the oscilloscope and confirm whether pin 4 has following pulse signal output.

Level rise slope	10us
Level fall slope	2us
Minimum time width for low level keep	30us

- Trig-In

1. Refer to the figure below to connect pin 4 to the external oscilloscope.

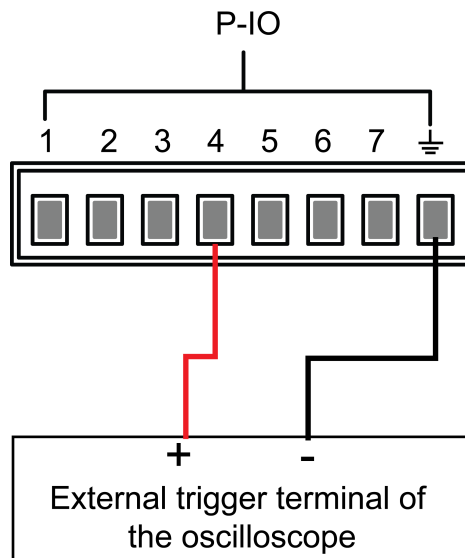

2. Set pin 4's function to **Not-Invert** and **Trig-In→List**.
3. Recall the edited List file for trigger running.
4. Set **ListTrig Source** to **External**.
5. Send pulse signals as per the following requirements from the external oscilloscope to pin 4.

Level rise slope	10us
Level fall slope	2us
Minimum time width for low level keep	30us

6. Observe the VFD screen on the instrument's front panel to confirm whether the List file is running or not.

5.11.5 IO-5. INH-Living, Not-Invert

Parameter Description

IO-5. Living, Not-Invert	Parameter setting for pin 5.	
	Not-Invert	Indicates whether to invert the input/output pulse or level signal.
	Invert	<ul style="list-style-type: none"> • Invert: Yes • Not-Invert: No

		Inhibit	This default function means that pin 5 of the P-IO controls the operation of the instrument.		
			Living	Select Living, and power supply will be operated in the mode of Living.	
			Latch	Select Latch, and power supply will be operated in the mode of Latch.	
		Input	Pin 5 receives the level signal from the outside.		
		Output	Pin 5 sends the digital signal (1, 0, PWM) to the outside.		
			True	By default (Not-Invert), the output digital signal is 1 (i.e. low level), and in the case of Invert , the output is high level.	
			False	By default (Not-Invert), the output digital signal is 0 (i.e. high level), and in the case of Invert , the output is low level.	
			PWM	Digital signal of PWM.	
				PWM Freq	Frequency
			PWM Duty	Duty cycle	

How to Use

The correspondence of the parameter settings is shown in the following table.

Whether to invert	Voltage between Pin5 and Pin8	Inhibit option	Actual output status after turning on [On/Off]
Not-Invert	5V high level (default)	Inhibit-Living	Normal output
		Inhibit-Latch	Normal output
	0V low level	Inhibit-Living	Disable the output, and does not affect the [On/Off] state. After the voltage between Pin5

Whether to invert	Voltage between Pin5 and Pin8	Inhibit option	Actual output status after turning on [On/Off]
			and Pin8 returns to 5V high level, the output returns to normal.
		Inhibit-Latch	Disable the output, and the [On/Off] is turned off. After the voltage between Pin5 and Pin8 returns to 5V high level, the output cannot be restored, you need to turn on [On/Off] manually.
Invert	0V low level (default)	Inhibit-Living	Normal output
		Inhibit-Latch	Normal output
	5V high level	Inhibit-Living	Disable the output, and does not affect the [On/Off] state. After the voltage between Pin5 and Pin8 returns to 0V low level, the output returns to normal.
		Inhibit-Latch	Disable the output, and the [On/Off] is turned off. After the voltage between Pin5 and Pin8 returns to 0V low level, the output cannot be restored, you need to turn on [On/Off] manually.

- When pin 5 is set to **Inhibit-Living (Not-Invert)**, pin 5 can control the instrument's output state based on the level signal from external input.
 - Under default conditions (namely, pin 5 is not connected), the input is high level, and it will not impact the instrument's output state.
 - When the [On/Off] is in On state, input low level to pin 5, and it will impact the output state: The [On/Off] button light is lighted on, but the actual output is 0; when pin 5 receives high level signal again, the output state is recovered.

Note

If pin 5 is set to **Invert**, input high level to pin 5, and it will impact the output state.

1. Referring to the figure below, connect pin 5 to the external oscilloscope.

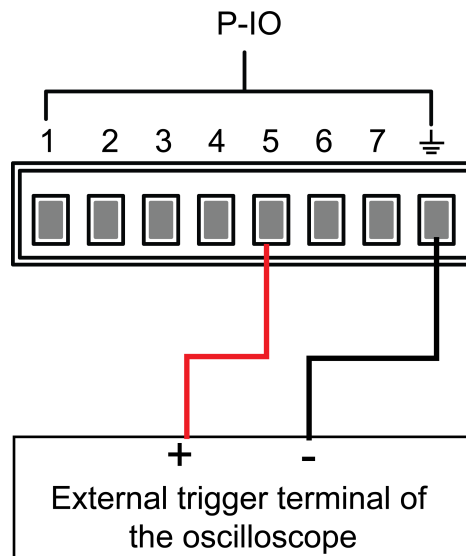

2. Set pin 5's function to **Not-Invert** and **Inhibit** → **Living**.
3. Set voltage to 10V and turn on [**On/Off**].
4. Input low level to pin 5.

At this point, the [**On/Off**] button light is lighted on, and VFD indicator light on the front panel displays **On**, while voltage/current Meter value gradually decreases to 0, the output function is prohibited. In addition, the VFD screen on the front panel displays **INH**.

5. Input high level to pin 5.

At this point, [**On/Off**] button light is lighted on, and VFD indicator light on the front panel displays **On**, and voltage/current Meter value gradually recovers to 10V, and the output function is re-initiated.

- When pin 5 is set to **Inhibit-Latch (Not-Invert)**, pin 5 can control the instrument's output state based on the pulse signal from external input. The parameter requirements of this pulse signal are as follows:

Level rise slope	10us
Level fall slope	2us
Minimum time width for low level keep	30us

- Under default conditions (pin 5 is not connected), it will not effect the instrument's output state.

- If **[On/Off]** is in On state, when pin 5 receives pulse signal, **[On/Off]** will be turned off: The **[On/Off]** button light is lighted off, and the VFD indicator light displays **Off**.

After confirming that the **[On/Off]** can be turned on again, the user needs to manually turn on **[On/Off]**.

1. Referring to the figure below, connect pin 5 to the external oscilloscope.

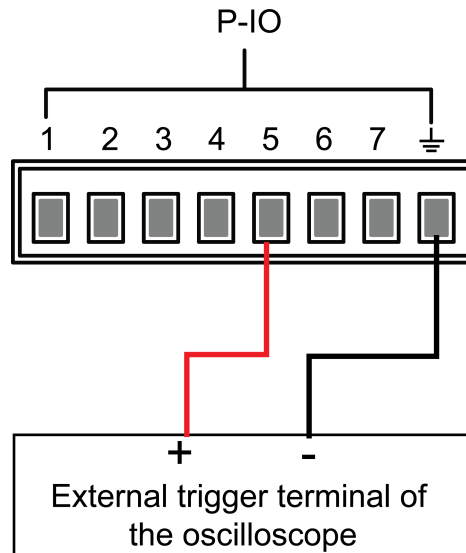

2. Set pin 5's function to **Not-Invert** and **Inhibit**→**Latch**.
3. Set voltage to 10V and turn on **[On/Off]**.
4. Input pulse signal to pin 5.

At this point, the **[On/Off]** button light is lighted off, and the VFD indicator light on the front panel displays **Off**, and the output function is switched off. In addition, the VFD screen on the front panel displays **INH LATCH**. When the protection state is cleared, manually turn on **[On/Off]** again.

5.11.6 IO-6. Sync-On, Not-Invert

Parameter Description

IO-6. Sync-On, Not-Invert	Parameter setting for pin 6.	
	Not-Invert	Indicates whether to invert the input/output pulse or level signal.
	Invert	<ul style="list-style-type: none"> • Invert: Yes • Not-Invert: No

		Sync-On	This default function means that pin 6 performs bi-directional and synchronous control over the turn-on of [On/Off] .					
		Input	Pin 6 receives the level signal from the outside.					
		Output	Pin 6 sends the digital signal (1, 0, PWM) to the outside.					
			True	By default (Not-Invert), the output digital signal is 1 (i.e. low level), and in the case of Invert , the output is high level.				
			False	By default (Not-Invert), the output digital signal is 0 (i.e. high level), and in the case of Invert , the output is low level.				
			PWM	Digital signal of PWM.				
				<table border="1"> <tr> <td>PWM Freq</td> <td>Frequency</td> </tr> <tr> <td>PWM Duty</td> <td>Duty cycle</td> </tr> </table>	PWM Freq	Frequency	PWM Duty	Duty cycle
PWM Freq	Frequency							
PWM Duty	Duty cycle							

How to Use

When pin 6 is set to default **Sync-On** function, pin 6 has bi-directional I/O function, which can receive pulse signal input from the external instrument and also can output pulse signal to external instrument. The parameter requirements of this pulse signal are as follows:

Level rise slope	10us
Level fall slope	2us
Minimum time width for low level keep	30us

The bi-direction I/O functions are introduced as below:

- Press **[On/Off]** on the instrument's front panel, the instrument's output is changed from Off to On. At this point, the pulse signal output from pin 6 can be detected.

- When the instrument's **[On/Off]** is in On state, input pulse signal to pin 6, and it will not impact the **[On/Off]** state.
- When the instrument's **[On/Off]** is in Off state, when pulse signal is input to pin 6, the **[On/Off]** will be changed from Off to ON.

Taking two instruments as an example, the operation is as below:

1. Referring to the figure below, connect pin 6 of two instruments to the external oscilloscope.

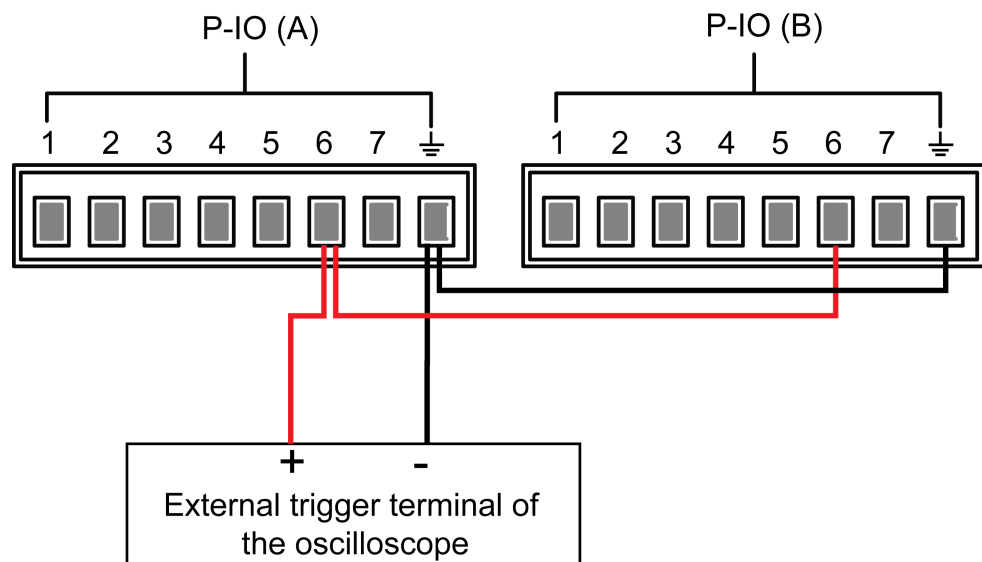

2. Set pin 6's function of two instruments to **Not-Invert** and **Sync-On**.
3. Confirm that the **[On/Off]** of both instruments is in Off state.
4. Set the voltage to 10V on the front panel of instrument A, and turn on **[On/Off]**.

At this time, check the oscilloscope. The instrument A's pin 6 outputs pulse signal and the instrument B's output function is synchronously turned on.

5.11.7 IO-7. Sync-Off, Not-Invert

Parameter Description

IO-7. Sync-Off, Not-Invert	Parameter setting for pin 7.	
	Not-Invert	Indicates whether to invert the input/output pulse or level signal.
	Invert	<ul style="list-style-type: none"> • Invert: Yes • Not-Invert: No

		Sync-Off	This default function means that pin 7 performs bi-directional and synchronous control over the turn-off of [On/Off] .	
		Input	Pin 7 receives the level signal from the outside.	
		Output	Pin 7 sends the digital signal (1, 0, PWM) to the outside.	
		True	By default (Not-Invert), the output digital signal is 1 (i.e. low level), and in the case of Invert , the output is high level.	
		False	By default (Not-Invert), the output digital signal is 0 (i.e. high level), and in the case of Invert , the output is low level.	
		PWM	Digital signal of PWM.	
			PWM Freq	Frequency
			PWM Duty	Duty cycle

How to Use

When pin 7 is set to default **Sync-Off** function, pin 7 has bi-directional I/O function, which can receive pulse signal input from the external instrument and also can output pulse signal to external instrument. The parameter requirements of this pulse signal are as follows:

Level rise slope	10us
Level fall slope	2us
Minimum time width for low level keep	30us

The bi-direction I/O functions are introduced as below:

- Press **[On/Off]** on the instrument's front panel, the instrument's output is changed from On to Off. At this point, the pulse signal output from pin 7 can be detected.

- When the instrument's **[On/Off]** is in Off state, input pulse signal to pin 7, and it will not impact the **[On/Off]** state.
- When the instrument's **[On/Off]** is in On state, input pulse signal to pin 7, and **[On/Off]** will be changed from On to Off.

Taking two instruments as an example, the operation is as below:

1. Referring to the figure below, connect pin 7 of two instruments to the external oscilloscope.

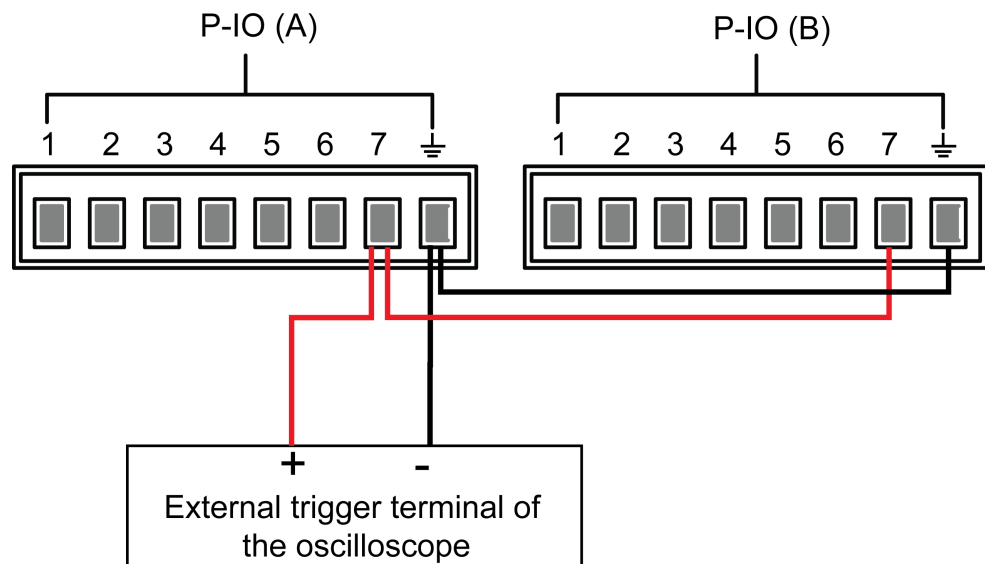

2. Set pin 7's function of two instruments to **Not-Invert** and **Sync-Off**.
3. Confirm that the **[On/Off]** of both instruments is in On state.
4. Press **[On/Off]** on the front panel of instrument A to turn off the output function.

At this time, check the oscilloscope. The instrument A's pin 7 outputs pulse signal and the instrument B's output function is synchronously turned off.

5.12 Analogue Function (Ext-Program) (Optional)

This menu item is used to control whether the external analog function is turned on. This function is not standard with the instrument and is optional for users. If the user does not select this function, this menu item will not be displayed.

The external analog function controls the actual output voltage/current value of the instrument by inputting a voltage between -10V and 10V to the specified pin, and limits the output of the voltage/current to a specified range.

The detailed parameter description is as below.

Ext-Program	External analog function menu					
	On / Off	Function switch: <ul style="list-style-type: none"> • On: Turns on the external analog function. In this state, the channel parameters cannot be set. • Off: Turns off the external analog function. In this state, the channel parameters can be set. 				
	Ch1	Set the parameters of channel 1 (programmed channel).				
		<table border="1"> <tr> <td>Mx</td> <td>Indicates the slope factor of channel 1.</td> </tr> <tr> <td>Mb</td> <td>Indicates the offset of channel 1.</td> </tr> </table>	Mx	Indicates the slope factor of channel 1.	Mb	Indicates the offset of channel 1.
Mx	Indicates the slope factor of channel 1.					
Mb	Indicates the offset of channel 1.					
	Ch2	Set the parameters of channel 2 (upper limit channel).				
		<table border="1"> <tr> <td>Mx</td> <td>Indicates the slope factor of channel 2.</td> </tr> <tr> <td>Mb</td> <td>Indicates the offset of channel 2.</td> </tr> </table>	Mx	Indicates the slope factor of channel 2.	Mb	Indicates the offset of channel 2.
Mx	Indicates the slope factor of channel 2.					
Mb	Indicates the offset of channel 2.					
	Ch3	Set the parameters of channel 3 (lower limit channel).				
		<table border="1"> <tr> <td>Mx</td> <td>Indicates the slope factor of channel 3.</td> </tr> <tr> <td>Mb</td> <td>Indicates the offset of channel 3.</td> </tr> </table>	Mx	Indicates the slope factor of channel 3.	Mb	Indicates the offset of channel 3.
Mx	Indicates the slope factor of channel 3.					
Mb	Indicates the offset of channel 3.					

- **CV priority:** The actual output voltage **Vs** will be adjusted according to the parameter setting of Ch1 and the input voltage of the corresponding pin. And, the current upper limit **I+** will be adjusted according to the parameter setting of Ch2 and the input voltage of the corresponding pin, the current lower limit **I-** will be adjusted according to the parameter setting of Ch3 and the input voltage of the corresponding pin.
- **CC priority:** The actual current voltage **Is** will be adjusted according to the parameter setting of Ch1 and the input voltage of the corresponding pin. And, the voltage upper limit **Vh** will be adjusted according to the parameter setting of Ch2 and the input voltage of the corresponding pin, the voltage lower limit **VI** will be adjusted according to the parameter setting of Ch3 and the input voltage of the corresponding pin.

Analog Card Interface Introduction

The analog function interface is located on the optional IT-E167. The pins description is as below.

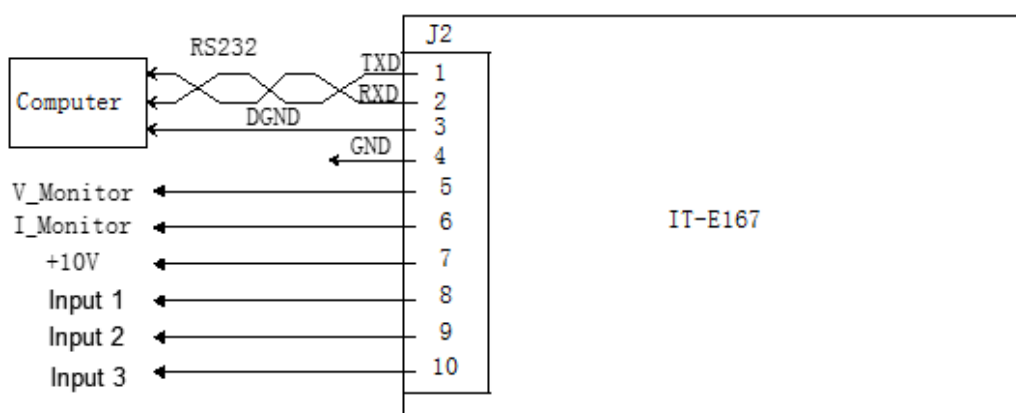

Pins	Description
4	Ground terminal
8	The setting for the output voltage/current value corresponds to Ch1 in the menu. <ul style="list-style-type: none"> CV priority: Specify the value of Vs. CC priority: Specify the value of Is.
9	The setting for the voltage/current upper limit corresponds to Ch2 in the menu. <ul style="list-style-type: none"> CV priority: Specify the value of the current upper limit I+. CC priority: Specify the value of the voltage upper limit Vh.
10	The setting for the voltage/current lower limit corresponds to Ch3 in the menu. <ul style="list-style-type: none"> CV priority: Specify the value of the current lower limit I-. CC priority: Specify the value of the voltage lower limit VI.

Analog Conversion Relationship Introduction

Taking the Ch1 programming channel as an example, the user needs to convert the values of Mx and Mb according to the following formulas, and then set the two values through the front panel keys or SCPI remote commands.



Note

The principle of parameter setting of Ch1 and Ch2 and Ch3 is the same, so the description will not be repeated.

Name	Description
V_{in1}	Indicates the start voltage input to pin 8. The setting range is from -10 to 10 .
V_{in2}	Indicates the end voltage input to pin 8. The setting range is from -10 to 10 , and $V_{in2} > V_{in1}$.
V_{out1}	The starting value of the output voltage in CV priority mode.
V_{out2}	The end value of the output voltage in CV priority mode, and $V_{out2} > V_{out1}$.
I_{out1}	The starting value of the output current in CC priority mode.
I_{out2}	The end value of the output current in CC priority mode, and $I_{out2} > I_{out1}$.

- **CV priority**

$$M_x = \frac{(V_{out2} - V_{out1})}{(V_{in2} - V_{in1})}$$

$$M_b = V_{out2} - V_{in2} \times M_x$$

- **CC priority**

$$M_x = \frac{(I_{out2} - I_{out1})}{(V_{in2} - V_{in1})}$$

$$M_b = I_{out2} - V_{in2} \times M_x$$

How to Use

The following takes the CV priority mode as an example to introduce the usage steps.

1. Refer to the figure below to complete the pin connection.

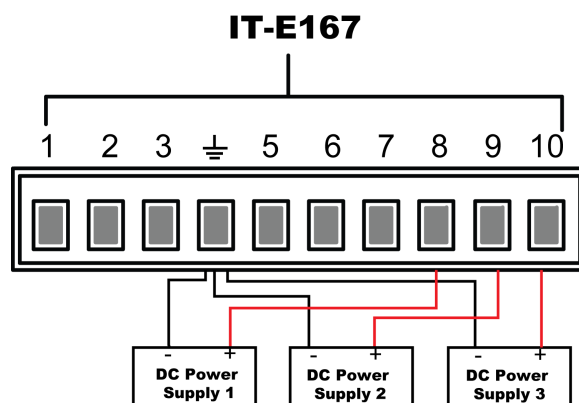

- Calculate the **Mx** and **Mb** under the Ch1, Ch2, Ch3 menus according to the above formulas.

The sample data used in this manual is shown in the table below.

Pins	Input Voltage	Output Voltage / Current	Mx	Mb	Description
8	$V_{in1} = -5$	$V_{out1} = 0$	50	250	By inputting a voltage of -5V to 5V to pin 8, the actual output voltage Vs is controlled from 0 to 500V.
	$V_{in2} = 5$	$V_{out2} = 500$			
9	$V_{in1} = -10$	$I_{+out1} = 0$	1.5	15	By inputting a voltage of -10V to 10V to pin 9, the actual output current upper limit I+ is controlled from 0 to 30A.
	$V_{in2} = 10$	$I_{+out2} = 30$			
10	$V_{in1} = -10$	$I_{-out1} = -30$	1.5	-15	By inputting a voltage of -10V to 10V to pin 10, the actual output current lower limit I- is controlled from -30 to 0A.
	$V_{in2} = 10$	$I_{-out2} = 0$			

- Press the composite keys **[Shift]+[P-set]** (System) on the front panel to enter the system menu.
- Use knob or Up/Down key to select **Ext-Program** and press **[Enter]**.
- According to step 2, set **Mx** and **Mb** of the corresponding pins.
- Set the **Ext-Program** → **On / Off** to **On** to turn on the analog function.

- Adjust the output of **DC Power Supply 1** from -5V to 5V, and adjust the output of **DC Power Supply 2, DC Power Supply 3** from -10V to 10V.

The actual output voltage and current of the instrument will change according to the following rules:

- Pin 8 controls the actual output voltage of the instrument from 0V to 500V.
- Pin 9, pin 10 monitor the actual output current of the instrument: When the output current is higher than the upper limit **I+** set by pin 9, the instrument outputs the current at the value of **I+**; When the output current is lower than the lower limit **I-** set by pin 10, the instrument outputs the current at the value of **I-**.

5.13 Restored to Factory Setting (System Reset)

This menu item is used to restore some parameter settings to factory setting values.

The procedures to set the menu item are as follows.

- Press the composite keys **[Shift]+[P-set]** (System) on the front panel to enter the system menu.
- Press the Up/Down key or turn the knob to select the **System Reset** and press **[Enter]**.
- Press the Left / Right key or turn the knob to adjust the value of this parameter.
 - No: Default value, indicates the instrument cancels this menu setting.
 - Yes: Indicates the instrument restores the factory default settings.
- After the parameter settings are complete, press **[Enter]**.

The parameters affected by **System Reset** and the parameter values after reset are shown in the following table.

Table 5–3 Initial value of the parameter

Category	Parameter	Initial Value
Main interface	Voltage setting: Vs	One percent of the rated voltage of the instrument
	Current setting: Is	One percent of the rated current of the instrument

Category	Parameter	Initial Value
	Upper limit of voltage: V_h , and lower limit of voltage: V_l	Upper limit value: One percent of the rated voltage of the instrument Lower limit value: 0
	Upper limit of current: I_+ , and lower limit of current: I_-	One percent of the rated current of the instrument
	Upper limit of power: P_+ , and lower limit of power: P_-	Rated power value of the instrument
	[On/Off] status	Off
System menu	Beep	On
	PowerOn	Reset
	Sense	Off
	ListTrig Source	Manual
	DataLogger Trig Source	Manual
	I/O Con	<ul style="list-style-type: none"> • LAN→IP-Conf <ul style="list-style-type: none"> • IP Addr: 192.168.0.1 • SubNet: 255.255.255.0 • Gateway: 192.168.0.1 • DNS1/DNS2: 0.0.0.0 • Socket Port: 30000 • LAN→Serv-Conf MDNS/PING/Telnet-scp/ Web/VX-11/ Raw-socket: On • VCP: 9600,8,N,1 • (Optional) RS232: 9600,8,N,1 • (Optional) External analog: Off

Category	Parameter	Initial Value
		<ul style="list-style-type: none"> (Optional) GPIB: Address=1
	Digital Port	<ul style="list-style-type: none"> IO-1: Ps-Clear IO-2: Ps IO-3: Off-Status IO-4: Ext-Trig IO-5: INH-Living IO-6: Sync-On IO-7: Sync-Off
	Parallel	Single
Config menu	Mode	CV
	Speed	High
	V-Rise Time/I-Rise Time	0.1s
	V-Fall Time/I-Fall Time	
	Output Res	0
	On Delay/Off Delay	0
Protect menu	OVP/OCP/OPP/UCP/UVP Status switch	Off
	OVP/OCP/OPP Protection point: Level	Rated voltage / current / power value of the instrument
	UCP/UVP Protection point: Level	0
	OVP/OCP/OPP/UCP/UVP Delay time: Delay	60s
	UCP/UVP Warm time: Warm-up	

5.14 View the System Information (System Info)

This menu item is used to view the system information of the instrument.

The procedures to view the system information are as follows.

1. Press the composite keys **[Shift]+[P-set]** (System) on the front panel to enter the system menu.
2. Press the Up/Down key or turn the knob to select the **System Info** and press **[Enter]**.

You can use Up/Down key or knob to view the following system information.

Parameter	Description
Model	Display the instrument model.
SN	Display the serial number.
Main Ver	Display the system version information.
Ctrl1 Ver	Display the version information of the control panel 1.
Ctrl2 Ver	Display the version information of the control panel 2.
Voltage Max	Display the maximum voltage value.
Voltage Min	Display the minimum voltage value.
Current Max	Display the maximum current value.
Current Min	Display the minimum current value.
Power Max	Display the maximum power value.
Power Min	Display the minimum power value.
Resistance Max	Display the maximum resistance value.
Resistance Min	Display the minimum resistance value.
Current Limit	Display the maximum current limit.
Run Time	Display the power-on time.
Boot Update Info	Boot Update Time

5.15 System Upgrade

The IT6000C series power supply supports the upgrade of the system version. System upgrade includes the following two methods:

- During the start-up period after the instrument is powered on, through the USB interface on the front panel, select the system upgrading files in the memory device (USB flash drive) for upgrading.
- The user can access to the Web service programs in the instrument by the Web browser on PC for upgrading operation.

This Chapter introduces in detail how to upgrade the system with the USB interface on the front panel. For the upgrading method of Web, see [2.6.2.1 Using Web Server](#).

Before You Upgrade

Before upgrading, you need to note the following points:

1. Description about system upgrading files.

Before upgrading, please contact ITECH technical staff to obtain the following two upgrading files, and put them under the root directory of the USB flash drive.

- `itech_6000_P.itech`

System upgrading package postfixed with **.itech**.

- `ItechConfig.txt`

System upgrading configuration file in text format. Before performing the upgrade, you need to open the configuration file with a text editing tool to confirm that the system upgrade package name in the configuration file is consistent with the present upgrading package name.

For example, when there are multiple system upgrading package postfixed with **.itech** in the root directory of your USB flash drive, you need to use a text editing tool to open the configuration file and specify the upgrade package name corresponding to the present upgrade operation.

2. The upgrading methods for single unit or units in parallel are slightly different: Under the parallel mode, the user can select to upgrade all units or a single unit only by operating the master. Therefore, the user needs to get access to SN numbers of all instruments in the parallel network (To obtain the unique ID for identifying instrument, see [5.14 View the System Information \(System Info\)](#)) for selective upgrading based on the SN number in subsequent upgrades.
3. If the upgrade fails, the interface will prompt **Update fail**. At this point, you cannot use the instrument. Please contact ITECH technical staff for treatment.

Upgrade Operation

- System Upgrade under Single-unit Mode
 1. Insert the USB flash drive into the USB interface on the front panel of the instrument.
 2. Power on the instrument. At this point, press **Shift** for several times till the instrument can detect the system upgrading files in the USB flash drive.

After the system upgrading files are detected, the interface displays as follows:

```
Update Select(01/01)
SN: ALL
```



Note

If the USB flash drive is not detected, select **Yes** to detect again; if **No** is selected, it means to exit upgrading, and the system will directly enter into the main interface.

3. Select **ALL**, and press **[Enter]**.

The system interface displays as follows:

```
Update ? (01/01)
No      Yes
```

4. Select **Yes**, and press **[Enter]**.

The system will automatically perform upgrading.



Note

If **No** is selected, it means to exit upgrading, and the system will directly enter into the main interface.

5. After the upgrading is completed, you need to restart the instrument manually.

- System Upgrade under Parallel Mode (Only Need to Operate the Master)
 1. Insert the USB flash drive into the USB interface on the front panel of the instrument.
 2. Power on the instrument. At this point, press **Shift** for several times till the instrument can detect the system upgrading files in the USB flash drive.

After the system upgrading files are detected, the interface displays as follows:

Update Select (xx/yy)

SN: ALL

xx means the number of selected instruments to be upgraded, and yy means the number of instruments in the parallel network.

3. Select upgrade in whole or in part based on actual needs. Then, press **[Enter]**.

- SN: ALL

Indicates to upgrade all.

- SN1: xxxxxxxxxxxxxxxxxxxx

Indicates to upgrade the selected instrument. Press Up/Down to check the SNs of all instruments in the parallel network; press Right to select the instrument; and press Right again to deselect the instrument.

4. Select **Yes**, and press **[Enter]**.

The system will automatically perform upgrading.



Note

If **No** is selected, it means to exit upgrading, and the system will directly enter into the main interface.

5. After the upgrading is completed, you need to restart the instrument manually.

6 Technical Specification

This chapter will introduce the main technical parameters of the instrument, such as rated voltage/current/power and so on. Besides, we will introduce the working environment and storage temperature.

- ◆ Main Specification
- ◆ 80V
- ◆ 300V
- ◆ 500V
- ◆ 800V
- ◆ 1500V
- ◆ 2250V
- ◆ Supplemental Characteristics

6.1 Main Specification

6.1.1 80V

6.1.1.1 IT6005C-80-150

Parameter		IT6005C-80-150
Rated value (0 °C-50 °C)	Output Voltage	0 ~ 80V
	Output Current	-150 ~ 150A
	Output Power	-5 ~ 5kW
	Output Resistance	0 ~ 0.533Ω
Line Regulation	Voltage	≤0.01%FS
±(% of Output+Offset)	Current	≤0.05%FS
Load Regulation	Voltage	≤0.02%FS
±(% of Output+Offset)	Current	≤0.05%FS
Setup Resolution	Voltage	0.001V
	Current	0.01A
	Power	0.001kW
	Resistance	0.001Ω
Read Back Resolution	Voltage	0.001V
	Current	0.01A
	Power	0.001kW
	Resistance	0.001Ω
Setup Accuracy (within 12 months, 25°C ±5°C) ±(% of Output+Offset)	Voltage	≤0.02%+0.02%FS
	Current	≤0.1%+0.1%FS
	Power	≤0.5%+0.5%FS
	Resistance	≤1% + 1%FS
Read Back Accuracy (within 12 months, 25°C ±5°C) ±(% of Output+Offset)	Voltage	≤0.02%+0.02%FS
	Current	≤0.1%+0.1%FS
	Power	≤0.5%+0.5%FS
	Resistance	≤1% + 1%FS
Ripple	Voltage	≤120mVpp(MAX:≤300mVpp)
(20Hz -20MHz)	Current	≤0.1%FS RMS
Setup Temperature Coefficient	Voltage	≤50PPM/°C

Parameter		IT6005C-80-150
±(% of Output/°C+Offset)	Current	≤200PPM/°C
Read Back Temperature Coefficient	Voltage	≤50PPM/°C
±(% of Output/°C+Offset)	Current	≤200PPM/°C
Rise Time(no load)	Voltage	≤15ms
Rise Time(full load)	Voltage	≤30ms
Fall Time(no load)	Voltage	≤30ms
Fall Time(full load)	Voltage	≤15ms
Transient Response Time	Voltage	≤2ms
AC Input	Voltage (Three-phase + PE) 1	198V ~ 264V (Power derating 50%) 342V ~ 528V
	Maximum Input Current	L1,L2/17A;L3/0A
	Maximum Input Apparent Power	5.7kVA
	Frequency	47Hz ~ 63Hz
Setup Stability-30min	Voltage	≤0.02%+0.02%FS
±(% of Output+Offset)	Current	≤0.1%+0.1%FS
Setup stability-8h	Voltage	≤0.02%+0.02%FS
±(% of Output+Offset)	Current	≤0.1%+0.1%FS
Readback Stability-30min	Voltage	≤0.02%+0.02%FS
±(% of Output+Offset)	Current	≤0.1%+0.1%FS
Readback stability-8h	Voltage	≤0.02%+0.02%FS
±(% of Output+Offset)	Current	≤0.1%+0.1%FS
Efficiency	~ 90%	
Remote Sense Compensation Voltage	≤5V	
Command Response Time	2mS	
Power Factor	0.99	
Storage Temperature	-10°C ~ 70°C	
Protective Function	OVP, OCP, OPP, UVP, UCP, OTP, Vsense protection	
Standard Interface	Standard: USB, CAN, LAN, VCP; optional: GPIB, analog card (includes RS232), fiber optic socket	
Isolation (output to ground)	500V	

Parameter	IT6005C-80-150
Working Temperature	0 ~ 50°C
Dimension (mm)	483mm(W)*801.61mm(D)*151.3mm(H)
Weight(net)	20KG

Note:

1. Models without emergency stop module (i.e. AC contactor not included), other AC input voltage ranges are required for customization. Models without emergency stop module and assembled to the cabinet, with AC input voltage in the range of 198~264V, need to be customized while derating by 50%. Models with emergency stop module (including AC contactor) only support 380VAC±10% for standard AC input voltage, 480VAC±10% voltage is required for customization.

6.1.1.2 IT6010C-80-300

Parameter		IT6010C-80-300
Rated value (0 °C-50 °C)	Output Voltage	0 ~ 80V
	Output Current	-300 ~ 300A
	Output Power	-10 ~ 10kW
	Output Resistance	0 ~ 0.267Ω
Line Regulation	Voltage	≤0.01%FS
±(%of Output+Offset)	Current	≤0.05%FS
Load Regulation	Voltage	≤0.02%FS
±(%of Output+Offset)	Current	≤0.05%FS
Setup Resolution	Voltage	0.001V
	Current	0.01A
	Power	0.001kW
	Resistance	0.001Ω
Read Back Resolution	Voltage	0.001V
	Current	0.01A
	Power	0.001kW
	Resistance	0.001Ω
Setup Accuracy (within 12 months, 25°C ±5°C)	Voltage	≤0.02% +0.02%FS
	Current	≤0.1% + 0.1%FS
	Power	≤0.5% + 0.5%FS
±(%of Output+Offset)		

Parameter		IT6010C-80-300
	Resistance	$\leq 1\% + 1\%FS$
Read Back Accuracy (within 12 months, 25°C ±5°C) ±(% of Output+Offset)	Voltage	$\leq 0.02\% + 0.02\%FS$
	Current	$\leq 0.1\% + 0.1\%FS$
	Power	$\leq 0.5\% + 0.5\%FS$
	Resistance	$\leq 1\% + 1\%FS$
Ripple	Voltage	$\leq 120mVpp(MAX:\leq 300mVpp)$
(20Hz -20MHz)	Current	$\leq 0.1\%FS$ RMS
Setup Temperature Coefficient	Voltage	$\leq 50PPM/^{\circ}C$
±(% of Output/ $^{\circ}C$ +Offset)	Current	$\leq 200PPM/^{\circ}C$
Read Back Temperature Coefficient	Voltage	$\leq 50PPM/^{\circ}C$
±(% of Output/ $^{\circ}C$ +Offset)	Current	$\leq 200PPM/^{\circ}C$
Rise Time(no load)	Voltage	$\leq 15ms$
Rise Time(full load)	Voltage	$\leq 30ms$
Fall Time(no load)	Voltage	$\leq 30ms$
Fall Time(full load)	Voltage	$\leq 15ms$
Transient Response Time	Voltage	$\leq 2ms$
AC Input	Voltage (Three-phase + PE) 1	198V ~ 264V (Power derating 50%) 342V ~ 528V
	Maximum Input Current	L1,L2/17A;L3/29A
	Maximum Input Apparent Power	11.3kVA
	Frequency	47Hz ~ 63Hz
Setup Stability-30min	Voltage	$\leq 0.02\%+0.02\%FS$
±(% of Output+Offset)	Current	$\leq 0.1\% + 0.1\%FS$
Setup stability-8h	Voltage	$\leq 0.02\%+0.02\%FS$
±(% of Output+Offset)	Current	$\leq 0.1\% + 0.1\%FS$
Readback Stability-30min	Voltage	$\leq 0.02\%+0.02\%FS$
±(% of Output+Offset)	Current	$\leq 0.1\% + 0.1\%FS$
Readback stability-8h	Voltage	$\leq 0.02\%+0.02\%FS$
±(% of Output+Offset)	Current	$\leq 0.1\% + 0.1\%FS$
Efficiency		~ 90%

Parameter		IT6010C-80-300
Remote Sense Compensation Voltage		≤5V
Command Response Time		2mS
Power Factor		0.99
Storage Temperature		-10°C ~ 70°C
Protective Function		OVP, OCP, OPP, UVP, UCP, OTP, Vsense protection
Standard Interface		Standard: USB, CAN, LAN, VCP; optional: GPIB, analog card (includes RS232), fiber optic socket
Isolation (output to ground)		500V
Working Temperature		0 ~ 50°C
Dimension (mm)		483mm(W)*801.61mm(D)*151.3mm(H)
Weight(net)		30KG

Note:

1. Models without emergency stop module (i.e. AC contactor not included), other AC input voltage ranges are required for customization. Models without emergency stop module and assembled to the cabinet, with AC input voltage in the range of 198~264V, need to be customized while derating by 50%. Models with emergency stop module (including AC contactor) only support 380VAC±10% for standard AC input voltage, 480VAC±10% voltage is required for customization.

6.1.1.3 IT6015C-80-450

Parameter		IT6015C-80-450
Rated value (0 °C-50 °C)	Output Voltage	0 ~ 80V
	Output Current	-450 ~ 450A
	Output Power	-15 ~ 15kW
	Output Resistance	0 ~ 0.178Ω
Line Regulation	Voltage	≤0.01%FS
±(% of Output+Offset)	Current	≤0.05%FS
Load Regulation	Voltage	≤0.02%FS
±(% of Output+Offset)	Current	≤0.05%FS
Setup Resolution	Voltage	0.001V
	Current	0.01A
	Power	0.001kW

Parameter		IT6015C-80-450
	Resistance	0.001Ω
Read Back Resolution	Voltage	0.001V
	Current	0.01A
	Power	0.001kW
	Resistance	0.001Ω
Setup Accuracy (within 12 months, 25°C ±5°C) ±(%of Output+Offset)	Voltage	≤0.02% + 0.02%FS
	Current	≤0.1% + 0.1%FS
	Power	≤0.5% + 0.5%FS
	Resistance	≤1% + 1%FS
Read Back Accuracy (within 12 months, 25°C ±5°C) ±(%of Output+Offset)	Voltage	≤0.02% + 0.02%FS
	Current	≤0.1% + 0.1%FS
	Power	≤0.5% + 0.5%FS
	Resistance	≤1% + 1%FS
Ripple (20Hz -20MHz)	Voltage	≤120mVpp(MAX: ≤200mVpp)
	Current	≤0.1%FS RMS
Setup Temperature Coefficient ±(%of Output/°C+Offset)	Voltage	≤50PPM/°C
	Current	≤200PPM/°C
Read Back Temperature Coefficient ±(%of Output/°C+Offset)	Voltage	≤50PPM/°C
	Current	≤200PPM/°C
Rise Time(no load)	Voltage	≤15ms
Rise Time(full load)	Voltage	≤30ms
Fall Time(no load)	Voltage	≤30ms
Fall Time(full load)	Voltage	≤15ms
Transient Response Time	Voltage	≤2ms
AC Input	Voltage (Three- phase + PE) 1	198V ~ 264V (Power derating 50%) 342V ~ 528V
	Maximum Input Current	28.42A
	Maximum Input Ap- parent Power	16.9kVA
	Frequency	47Hz ~ 63Hz

Parameter		IT6015C-80-450
Setup Stability-30min	Voltage	$\leq 0.02\% + 0.02\%FS$
\pm (%of Output+Offset)	Current	$\leq 0.1\% + 0.1\%FS$
Setup stability-8h	Voltage	$\leq 0.02\% + 0.02\%FS$
\pm (%of Output+Offset)	Current	$\leq 0.1\% + 0.1\%FS$
Readback Stability-30min	Voltage	$\leq 0.02\% + 0.02\%FS$
\pm (%of Output+Offset)	Current	$\leq 0.1\% + 0.1\%FS$
Readback stability-8h	Voltage	$\leq 0.02\% + 0.02\%FS$
\pm (%of Output+Offset)	Current	$\leq 0.1\% + 0.1\%FS$
Efficiency	~ 90%	
Remote Sense Compensation Voltage	$\leq 5V$	
Command Response Time	2mS	
Power Factor	0.99	
Storage Temperature	$-10^{\circ}C \sim 70^{\circ}C$	
Protective Function	OVP, OCP, OPP, UVP, UCP, OTP, Vsense protection	
Standard Interface	Standard: USB, CAN, LAN, VCP; optional: GPIB, analog card (includes RS232), fiber optic socket	
Isolation (output to ground)	500V	
Working Temperature	$0 \sim 50^{\circ}C$	
Dimension (mm)	483mm(W)*801.61mm(D)*151.3mm(H)	
Weight(net)	40KG	

Note:

1. Models without emergency stop module (i.e. AC contactor not included), other AC input voltage ranges are required for customization. Models without emergency stop module and assembled to the cabinet, with AC input voltage in the range of 198~264V, need to be customized while derating by 50%. Models with emergency stop module (including AC contactor) only support $380VAC \pm 10\%$ for standard AC input voltage, $480VAC \pm 10\%$ voltage is required for customization.

6.1.1.4 IT6030C-80-900

Parameter		IT6030C-80-900
Rated value ($0^{\circ}C-50^{\circ}C$)	Output Voltage	$0 \sim 80V$
	Output Current	$-900 \sim 900A$
	Output Power	$-30kW \sim 30kW$

Parameter		IT6030C-80-900
	Output Resistance	0 ~ 0.089Ω
Line Regulation	Voltage	≤0.01%FS
±(% of Output+Offset)	Current	≤0.05%FS
Load Regulation	Voltage	≤0.02%FS
±(% of Output+Offset)	Current	≤0.05%FS
Setup Resolution	Voltage	0.001V
	Current	0.1A
	Power	0.001kW
	Resistance	0.001Ω
Read Back Resolution	Voltage	0.001V
	Current	0.1A
	Power	0.001kW
	Resistance	0.001Ω
Setup Accuracy (within 12 months, 25°C ±5°C) ±(% of Output+Offset)	Voltage	≤0.02% + 0.02%FS
	Current	≤0.1% + 0.1%FS
	Power	≤0.5% + 0.5%FS
	Resistance	≤1% + 1%FS
Read Back Accuracy (within 12 months, 25°C ±5°C) ±(% of Output+Offset)	Voltage	≤0.02% + 0.02%FS
	Current	≤0.1% + 0.1%FS
	Power	≤0.5% + 0.5%FS
	Resistance	≤1% + 1%FS
Ripple	Voltage	≤120mVpp(MAX: ≤200mVpp)
(20Hz -20MHz)	Current	≤0.1%FS RMS
Setup Temperature Coefficient	Voltage	≤50PPM/°C
±(% of Output/°C+Offset)	Current	≤200PPM/°C
Read Back Temperature Coefficient	Voltage	≤50PPM/°C
±(% of Output/°C+Offset)	Current	≤200PPM/°C
Rise Time(no load)	Voltage	≤15ms
Rise Time(full load)	Voltage	≤30ms
Fall Time(no load)	Voltage	≤30ms

Parameter		IT6030C-80-900
Fall Time(full load)	Voltage	≤15ms
Transient Response Time	Voltage	≤2ms
AC Input	Voltage (Three-phase + PE) 1	198V ~ 264V (Power derating 50%) 342V ~ 528V
	Maximum Input Current	56.84A
	Maximum Input Apparent Power	33.7kVA
	Frequency	47Hz ~ 63Hz
Setup Stability-30min	Voltage	≤0.02% + 0.02%FS
±(%of Output+Offset)	Current	≤0.1% + 0.1%FS
Setup stability-8h	Voltage	≤0.02% + 0.02%FS
±(%of Output+Offset)	Current	≤0.1% + 0.1%FS
Readback Stability-30min	Voltage	≤0.02% + 0.02%FS
±(%of Output+Offset)	Current	≤0.1% + 0.1%FS
Readback stability-8h	Voltage	≤0.02% + 0.02%FS
±(%of Output+Offset)	Current	≤0.1% + 0.1%FS
Efficiency	~ 90%	
Remote Sense Compensation Voltage	≤5V	
Command Response Time	2mS	
Power Factor	0.99	
Storage Temperature	-10°C ~ 70°C	
Protective Function	OVP, OCP, OPP, UVP, UCP, OTP, Vsense protection	
Standard Interface	Standard: USB, CAN, LAN, VCP; optional: GPIB, analog card (includes RS232), fiber optic socket	
Isolation (output to ground)	500V	
Working Temperature	0 ~ 50°C	
Dimension (mm)	483mm(W)*801.61mm(D)*348.84mm(H)	
Weight(net)	95KG	

Note:

Parameter	IT6030C-80-900
-----------	----------------

1. Models without emergency stop module (i.e. AC contactor not included), other AC input voltage ranges are required for customization. Models without emergency stop module and assembled to the cabinet, with AC input voltage in the range of 198~264V, need to be customized while derating by 50%. Models with emergency stop module (including AC contactor) only support 380VAC±10% for standard AC input voltage, 480VAC±10% voltage is required for customization.

6.1.1.5 IT6045C-80-1350

Parameter		IT6045C-80-1350
Rated value (0 °C-50 °C)	Output Voltage	0 ~ 80V
	Output Current	-1350 ~ 1350A
	Output Power	-45kW ~ 45kW
	Output Resistance	0 ~ 0.059Ω
Line Regulation	Voltage	≤0.01%FS
±(% of Output+Offset)	Current	≤0.05%FS
Load Regulation	Voltage	≤0.02%FS
±(% of Output+Offset)	Current	≤0.05%FS
Setup Resolution	Voltage	0.001V
	Current	0.1A
	Power	0.001kW
	Resistance	0.001Ω
Read Back Resolution	Voltage	0.001V
	Current	0.1A
	Power	0.001kW
	Resistance	0.001Ω
Setup Accuracy (within 12 months, 25°C ±5°C) ±(% of Output+Offset)	Voltage	≤0.02% + 0.02%FS
	Current	≤0.1% + 0.1%FS
	Power	≤0.5% + 0.5%FS
	Resistance	≤1% + 1%FS
Read Back Accuracy (within 12 months, 25°C ±5°C) ±(% of Output+Offset)	Voltage	≤0.02% + 0.02%FS
	Current	≤0.1% + 0.1%FS
	Power	≤0.5% + 0.5%FS

Parameter		IT6045C-80-1350
	Resistance	$\leq 1\% + 1\%FS$
Ripple	Voltage	$\leq 120mV_{pp}(MAX: \leq 200mV_{pp})$
(20Hz -20MHz)	Current	$\leq 0.1\%FS RMS$
Setup Temperature Coefficient	Voltage	$\leq 50PPM/^{\circ}C$
$\pm(\% \text{ of Output}/^{\circ}C + \text{Offset})$	Current	$\leq 200PPM/^{\circ}C$
Read Back Temperature Coefficient	Voltage	$\leq 50PPM/^{\circ}C$
$\pm(\% \text{ of Output}/^{\circ}C + \text{Offset})$	Current	$\leq 200PPM/^{\circ}C$
Rise Time(no load)	Voltage	$\leq 15ms$
Rise Time(full load)	Voltage	$\leq 30ms$
Fall Time(no load)	Voltage	$\leq 30ms$
Fall Time(full load)	Voltage	$\leq 15ms$
Transient Response Time	Voltage	$\leq 2ms$
AC Input	Voltage (Three-phase + PE) 1	198V ~ 264V (Power derating 50%) 342V ~ 528V
	Maximum Input Current	85.26A
	Maximum Input Apparent Power	50.5kVA
	Frequency	47Hz ~ 63Hz
Setup Stability-30min	Voltage	$\leq 0.02\% + 0.02\%FS$
$\pm(\% \text{ of Output} + \text{Offset})$	Current	$\leq 0.1\% + 0.1\%FS$
Setup stability-8h	Voltage	$\leq 0.02\% + 0.02\%FS$
$\pm(\% \text{ of Output} + \text{Offset})$	Current	$\leq 0.1\% + 0.1\%FS$
Readback Stability-30min	Voltage	$\leq 0.02\% + 0.02\%FS$
$\pm(\% \text{ of Output} + \text{Offset})$	Current	$\leq 0.1\% + 0.1\%FS$
Readback stability-8h	Voltage	$\leq 0.02\% + 0.02\%FS$
$\pm(\% \text{ of Output} + \text{Offset})$	Current	$\leq 0.1\% + 0.1\%FS$
Efficiency		~ 90%
Remote Sense Compensation Voltage		$\leq 5V$
Command Response Time		2mS
Power Factor		0.99
Storage Temperature		$-10^{\circ}C \sim 70^{\circ}C$

Parameter	IT6045C-80-1350
Protective Function	OVP, OCP, OPP, UVP, UCP, OTP, Vsense protection
Standard Interface	Standard: USB, CAN, LAN, VCP; optional: GPIB, analog card (includes RS232), fiber optic socket
Isolation (output to ground)	500V
Working Temperature	0 ~ 50°C
Dimension (mm)	550mm(W)*910.16mm(D)*907.64mm(H)
Weight(net)	186KG

Note: 1. Models without emergency stop module (i.e. AC contactor not included), other AC input voltage ranges are required for customization. Models without emergency stop module and assembled to the cabinet, with AC input voltage in the range of 198~264V, need to be customized while derating by 50%. Models with emergency stop module (including AC contactor) only support 380VAC±10% for standard AC input voltage, 480VAC±10% voltage is required for customization.

6.1.1.6 IT6060C-80-1800

Parameter		IT6060C-80-1800
Rated value (0 °C-50 °C)	Output Voltage	0 ~ 80V
	Output Current	-1800 ~ 1800A
	Output Power	-60 ~ 60kW
	Output Resistance	0 ~ 0.044Ω
Line Regulation	Voltage	≤0.01%FS
±(% of Output+Offset)	Current	≤0.05%FS
Load Regulation	Voltage	≤0.02%FS
±(% of Output+Offset)	Current	≤0.05%FS
Setup Resolution	Voltage	0.001V
	Current	0.1A
	Power	0.001kW
	Resistance	0.001Ω
Read Back Resolution	Voltage	0.001V
	Current	0.1A
	Power	0.001kW
	Resistance	0.001Ω
Setup Accuracy	Voltage	≤0.02% + 0.02%FS

Parameter		IT6060C-80-1800
(within 12 months, 25°C ±5°C) ±(% of Output+Offset)	Current	≤0.1% + 0.1%FS
	Power	≤0.5% + 0.5%FS
	Resistance	≤1% + 1%FS
Read Back Accuracy (within 12 months, 25°C ±5°C) ±(% of Output+Offset)	Voltage	≤0.02% + 0.02%FS
	Current	≤0.1% + 0.1%FS
	Power	≤0.5% + 0.5%FS
	Resistance	≤1% + 1%FS
Ripple	Voltage	≤120mVpp(MAX: ≤200mVpp)
(20Hz -20MHz)	Current	≤0.1%FS RMS
Setup Temperature Coefficient	Voltage	≤50PPM/°C
±(% of Output/°C+Offset)	Current	≤200PPM/°C
Read Back Temperature Coefficient	Voltage	≤50PPM/°C
±(% of Output/°C+Offset)	Current	≤200PPM/°C
Rise Time(no load)	Voltage	≤15ms
Rise Time(full load)	Voltage	≤30ms
Fall Time(no load)	Voltage	≤30ms
Fall Time(full load)	Voltage	≤15ms
Transient Response Time	Voltage	≤2ms
AC Input	Voltage (Three-phase + PE) 1	198V ~ 264V (Power derating 50%) 342V ~ 528V
	Maximum Input Current	113.68A
	Maximum Input Apparent Power	67.3kVA
	Frequency	47Hz ~ 63Hz
Setup Stability-30min	Voltage	≤0.02% + 0.02%FS
±(% of Output+Offset)	Current	≤0.1% + 0.1%FS
Setup stability-8h	Voltage	≤0.02% + 0.02%FS
±(% of Output+Offset)	Current	≤0.1% + 0.1%FS
Readback Stability-30min	Voltage	≤0.02% + 0.02%FS
±(% of Output+Offset)	Current	≤0.1% + 0.1%FS

Parameter		IT6060C-80-1800
Readback stability-8h	Voltage	$\leq 0.02\% + 0.02\%FS$
\pm (%of Output+Offset)	Current	$\leq 0.1\% + 0.1\%FS$
Efficiency		~ 90%
Remote Sense Compensation Voltage		$\leq 5V$
Command Response Time		2mS
Power Factor		0.99
Storage Temperature		-10°C ~ 70°C
Protective Function		OVP, OCP, OPP, UVP, UCP, OTP, Vsense protection
Standard Interface		Standard: USB, CAN, LAN, VCP; optional: GPIB, analog card (includes RS232), fiber optic socket
Isolation (output to ground)		500V
Working Temperature		0 ~ 50°C
Dimension (mm)		550mm(W)*910.16mm(D)*907.64mm(H)
Weight(net)		228.9KG

Note: 1. Models without emergency stop module (i.e. AC contactor not included), other AC input voltage ranges are required for customization. Models without emergency stop module and assembled to the cabinet, with AC input voltage in the range of 198~264V, need to be customized while derating by 50%. Models with emergency stop module (including AC contactor) only support 380VAC \pm 10% for standard AC input voltage, 480VAC \pm 10% voltage is required for customization.

6.1.1.7 IT6075C-80-2040

Parameter		IT6075C-80-2040
Rated value (0 °C-50 °C)	Output Voltage	0 ~ 80V
	Output Current	-2040 ~ 2040A
	Output Power	-75 ~ 75kW
	Output Resistance	0 ~ 0.039 Ω
Line Regulation	Voltage	$\leq 0.01\%FS$
\pm (%of Output+Offset)	Current	$\leq 0.05\%FS$
Load Regulation	Voltage	$\leq 0.02\%FS$
\pm (%of Output+Offset)	Current	$\leq 0.05\%FS$
Setup Resolution	Voltage	0.001V
	Current	0.1A

Parameter		IT6075C-80-2040
	Power	0.001kW
	Resistance	0.001Ω
Read Back Resolution	Voltage	0.001V
	Current	0.1A
	Power	0.001kW
	Resistance	0.001Ω
Setup Accuracy (within 12 months, 25°C ±5°C) ±(%of Output+Offset)	Voltage	≤0.02% + 0.02%FS
	Current	≤0.1% + 0.1%FS
	Power	≤0.5% + 0.5%FS
	Resistance	≤1% + 1%FS
Read Back Accuracy (within 12 months, 25°C ±5°C) ±(%of Output+Offset)	Voltage	≤0.02% + 0.02%FS
	Current	≤0.1% + 0.1%FS
	Power	≤0.5% + 0.5%FS
	Resistance	≤1% + 1%FS
Ripple	Voltage	≤120mVpp(MAX: ≤200mVpp)
(20Hz -20MHz)	Current	≤0.1%FS RMS
Setup Temperature Coefficient	Voltage	≤50PPM/°C
±(%of Output/°C+Offset)	Current	≤200PPM/°C
Read Back Temperature Coefficient	Voltage	≤50PPM/°C
±(%of Output/°C+Offset)	Current	≤200PPM/°C
Rise Time(no load)	Voltage	≤15ms
Rise Time(full load)	Voltage	≤30ms
Fall Time(no load)	Voltage	≤30ms
Fall Time(full load)	Voltage	≤15ms
Transient Response Time	Voltage	≤2ms
AC Input	Voltage (Three- phase + PE) 1	198V ~ 264V (Power derating 50%) 342V ~ 528V
	Maximum Input Current	142.1A
	Maximum Input Ap- parent Power	84.2kVA

Parameter		IT6075C-80-2040
	Frequency	47Hz ~ 63Hz
Setup Stability-30min	Voltage	$\leq 0.02\% + 0.02\%FS$
\pm (% of Output+Offset)	Current	$\leq 0.1\% + 0.1\%FS$
Setup stability-8h	Voltage	$\leq 0.02\% + 0.02\%FS$
\pm (% of Output+Offset)	Current	$\leq 0.1\% + 0.1\%FS$
Readback Stability-30min	Voltage	$\leq 0.02\% + 0.02\%FS$
\pm (% of Output+Offset)	Current	$\leq 0.1\% + 0.1\%FS$
Readback stability-8h	Voltage	$\leq 0.02\% + 0.02\%FS$
\pm (% of Output+Offset)	Current	$\leq 0.1\% + 0.1\%FS$
Efficiency		~ 90%
Remote Sense Compensation Voltage		$\leq 5V$
Command Response Time		2mS
Power Factor		0.99
Storage Temperature		-10°C ~ 70°C
Protective Function		OVP, OCP, OPP, UVP, UCP, OTP, Vsense protection
Standard Interface		Standard: USB, CAN, LAN, VCP; optional: GPIB, analog card (includes RS232), fiber optic socket
Isolation (output to ground)		500V
Working Temperature		0 ~ 50°C
Dimension (mm)		600mm(W)*917.61mm(D)*1441.41mm(H)
Weight(net)		323.5KG

Note: 1. Models without emergency stop module (i.e. AC contactor not included), other AC input voltage ranges are required for customization. Models without emergency stop module and assembled to the cabinet, with AC input voltage in the range of 198~264V, need to be customized while derating by 50%. Models with emergency stop module (including AC contactor) only support 380VAC \pm 10% for standard AC input voltage, 480VAC \pm 10% voltage is required for customization.

6.1.1.8 IT6090C-80-2040

Parameter		IT6090C-80-2040
Rated value (0 °C-50 °C)	Output Voltage	0 ~ 80V
	Output Current	-2040 ~ 2040A
	Output Power	-90 ~ 90kW

Parameter		IT6090C-80-2040
	Output Resistance	0 ~ 0.039Ω
Line Regulation	Voltage	≤0.01%FS
±(% of Output+Offset)	Current	≤0.05%FS
Load Regulation	Voltage	≤0.02%FS
±(% of Output+Offset)	Current	≤0.05%FS
Setup Resolution	Voltage	0.001V
	Current	0.1A
	Power	0.001kW
	Resistance	0.001Ω
Read Back Resolution	Voltage	0.001V
	Current	0.1A
	Power	0.001kW
	Resistance	0.001Ω
Setup Accuracy (within 12 months, 25°C ±5°C) ±(% of Output+Offset)	Voltage	≤0.02% + 0.02%FS
	Current	≤0.1% + 0.1%FS
	Power	≤0.5% + 0.5%FS
	Resistance	≤1% + 1%FS
Read Back Accuracy (within 12 months, 25°C ±5°C) ±(% of Output+Offset)	Voltage	≤0.02% + 0.02%FS
	Current	≤0.1% + 0.1%FS
	Power	≤0.5% + 0.5%FS
	Resistance	≤1% + 1%FS
Ripple	Voltage	≤120mVpp(MAX: ≤200mVpp)
(20Hz -20MHz)	Current	≤0.1%FS RMS
Setup Temperature Coefficient	Voltage	≤50PPM/°C
±(% of Output/°C+Offset)	Current	≤200PPM/°C
Read Back Temperature Coefficient	Voltage	≤50PPM/°C
±(% of Output/°C+Offset)	Current	≤200PPM/°C
Rise Time(no load)	Voltage	≤15ms
Rise Time(full load)	Voltage	≤30ms
Fall Time(no load)	Voltage	≤30ms

Parameter		IT6090C-80-2040
Fall Time(full load)	Voltage	≤15ms
Transient Response Time	Voltage	≤2ms
AC Input	Voltage (Three-phase + PE) 1	198V ~ 264V (Power derating 50%) 342V ~ 528V
	Maximum Input Current	170.52A
	Maximum Input Apparent Power	101kVA
	Frequency	47Hz ~ 63Hz
Setup Stability-30min	Voltage	≤0.02% + 0.02%FS
±(% of Output+Offset)	Current	≤0.1% + 0.1%FS
Setup stability-8h	Voltage	≤0.02% + 0.02%FS
±(% of Output+Offset)	Current	≤0.1% + 0.1%FS
Readback Stability-30min	Voltage	≤0.02% + 0.02%FS
±(% of Output+Offset)	Current	≤0.1% + 0.1%FS
Readback stability-8h	Voltage	≤0.02% + 0.02%FS
±(% of Output+Offset)	Current	≤0.1% + 0.1%FS
Efficiency		~ 90%
Remote Sense Compensation Voltage		≤5V
Command Response Time		2mS
Power Factor		0.99
Storage Temperature		-10°C ~ 70°C
Protective Function		OVP, OCP, OPP, UVP, UCP, OTP, Vsense protection
Standard Interface		Standard: USB, CAN, LAN, VCP; optional: GPIB, analog card (includes RS232), fiber optic socket
Isolation (output to ground)		500V
Working Temperature		0 ~ 50°C
Dimension (mm)		600mm(W)*917.61mm(D)*1441.41mm(H)
Weight(net)		366.5KG

Note: 1. Models without emergency stop module (i.e. AC contactor not included), other AC input voltage ranges are required for customization. Models without emergency stop module and assembled to the cabinet, with AC input voltage in the range of 198~264V, need to be customized while derating by 50%. Models with emergency stop module (including AC contactor) only support 380VAC±10% for standard AC input voltage, 480VAC±10% voltage is required for customization.

6.1.1.9 IT6105C-80-2040

Parameter		IT6105C-80-2040
Rated value (0 °C-50 °C)	Output Voltage	0 ~ 80V
	Output Current	-2040 ~ 2040A
	Output Power	-105 ~ 105kW
	Output Resistance	0 ~ 0.039Ω
Line Regulation	Voltage	≤0.01%FS
±(% of Output+Offset)	Current	≤0.05%FS
Load Regulation	Voltage	≤0.02%FS
±(% of Output+Offset)	Current	≤0.05%FS
Setup Resolution	Voltage	0.001V
	Current	0.1A
	Power	0.001kW
	Resistance	0.001Ω
Read Back Resolution	Voltage	0.001V
	Current	0.1A
	Power	0.001kW
	Resistance	0.001Ω
Setup Accuracy (within 12 months, 25°C ±5°C) ±(% of Output+Offset)	Voltage	≤0.02% + 0.02%FS
	Current	≤0.1% + 0.1%FS
	Power	≤0.5% + 0.5%FS
	Resistance	≤1% + 1%FS
Read Back Accuracy (within 12 months, 25°C ±5°C) ±(% of Output+Offset)	Voltage	≤0.02% + 0.02%FS
	Current	≤0.1% + 0.1%FS
	Power	≤0.5% + 0.5%FS
	Resistance	≤1% + 1%FS
Ripple	Voltage	≤120mVpp(MAX: ≤200mVpp)
(20Hz -20MHz)	Current	≤0.1%FS RMS
Setup Temperature Coefficient	Voltage	≤50PPM/°C
±(% of Output/°C+Offset)	Current	≤200PPM/°C

Parameter		IT6105C-80-2040
Read Back Temperature Coefficient	Voltage	≤50PPM/°C
±(% of Output/°C+Offset)	Current	≤200PPM/°C
Rise Time(no load)	Voltage	≤15ms
Rise Time(full load)	Voltage	≤30ms
Fall Time(no load)	Voltage	≤30ms
Fall Time(full load)	Voltage	≤15ms
Transient Response Time	Voltage	≤2ms
AC Input	Voltage (Three-phase + PE) 1	198V ~ 264V (Power derating 50%) 342V ~ 528V
	Maximum Input Current	198.94A
	Maximum Input Apparent Power	117.8kVA
	Frequency	47Hz ~ 63Hz
Setup Stability-30min	Voltage	≤0.02% + 0.02%FS
±(% of Output+Offset)	Current	≤0.1% + 0.1%FS
Setup stability-8h	Voltage	≤0.02% + 0.02%FS
±(% of Output+Offset)	Current	≤0.1% + 0.1%FS
Readback Stability-30min	Voltage	≤0.02% + 0.02%FS
±(% of Output+Offset)	Current	≤0.1% + 0.1%FS
Readback stability-8h	Voltage	≤0.02% + 0.02%FS
±(% of Output+Offset)	Current	≤0.1% + 0.1%FS
Efficiency	~ 90%	
Remote Sense Compensation Voltage	≤5V	
Command Response Time	2mS	
Power Factor	0.99	
Storage Temperature	-10°C ~ 70°C	
Protective Function	OVP, OCP, OPP, UVP, UCP, OTP, Vsense protection	
Standard Interface	Standard: USB, CAN, LAN, VCP; optional: GPIB, analog card (includes RS232), fiber optic socket	
Isolation (output to ground)	500V	
Working Temperature	0 ~ 50°C	

Parameter		IT6105C-80-2040
Dimension (mm)	600mm(W)*917.61mm(D)*1441.41mm(H)	
Weight(net)	409.7KG	

Note: 1. Models without emergency stop module (i.e. AC contactor not included), other AC input voltage ranges are required for customization. Models without emergency stop module and assembled to the cabinet, with AC input voltage in the range of 198~264V, need to be customized while derating by 50%. Models with emergency stop module (including AC contactor) only support 380VAC±10% for standard AC input voltage, 480VAC±10% voltage is required for customization.

6.1.1.10 IT6120C-80-2040

Parameter		IT6120C-80-2040
Rated value (0 °C-50 °C)	Output Voltage	0 ~ 80V
	Output Current	-2040 ~ 2040A
	Output Power	-120 ~ 120kW
	Output Resistance	0 ~ 0.039Ω
Line Regulation	Voltage	≤0.01%FS
±(%of Output+Offset)	Current	≤0.05%FS
Load Regulation	Voltage	≤0.02%FS
±(%of Output+Offset)	Current	≤0.05%FS
Setup Resolution	Voltage	0.001V
	Current	0.1A
	Power	0.001kW
	Resistance	0.001Ω
Read Back Resolution	Voltage	0.001V
	Current	0.1A
	Power	0.001kW
	Resistance	0.001Ω
Setup Accuracy (within 12 months, 25°C ±5°C) ±(%of Output+Offset)	Voltage	≤0.02% + 0.02%FS
	Current	≤0.1% + 0.1%FS
	Power	≤0.5% + 0.5%FS
	Resistance	≤1% + 1%FS
Read Back Accuracy	Voltage	≤0.02% + 0.02%FS

Parameter		IT6120C-80-2040
(within 12 months, 25°C ±5°C) ±(% of Output+Offset)	Current	≤0.1% + 0.1%FS
	Power	≤0.5% + 0.5%FS
	Resistance	≤1% + 1%FS
Ripple	Voltage	≤120mVpp(MAX: ≤200mVpp)
(20Hz -20MHz)	Current	≤0.1%FS RMS
Setup Temperature Coefficient	Voltage	≤50PPM/°C
±(% of Output/°C+Offset)	Current	≤200PPM/°C
Read Back Temperature Coefficient	Voltage	≤50PPM/°C
±(% of Output/°C+Offset)	Current	≤200PPM/°C
Rise Time(no load)	Voltage	≤15ms
Rise Time(full load)	Voltage	≤30ms
Fall Time(no load)	Voltage	≤30ms
Fall Time(full load)	Voltage	≤15ms
Transient Response Time	Voltage	≤2ms
AC Input	Voltage (Three-phase + PE) 1	198V ~ 264V (Power derating 50%) 342V ~ 528V
	Maximum Input Current	227.36A
	Maximum Input Apparent Power	134.7kVA
	Frequency	47Hz ~ 63Hz
Setup Stability-30min	Voltage	≤0.02% + 0.02%FS
±(% of Output+Offset)	Current	≤0.1% + 0.1%FS
Setup stability-8h	Voltage	≤0.02% + 0.02%FS
±(% of Output+Offset)	Current	≤0.1% + 0.1%FS
Readback Stability-30min	Voltage	≤0.02% + 0.02%FS
±(% of Output+Offset)	Current	≤0.1% + 0.1%FS
Readback stability-8h	Voltage	≤0.02% + 0.02%FS
±(% of Output+Offset)	Current	≤0.1% + 0.1%FS
Efficiency	~ 90%	
Remote Sense Compensation Voltage	≤5V	

Parameter	IT6120C-80-2040
Command Response Time	2mS
Power Factor	0.99
Storage Temperature	-10°C ~ 70°C
Protective Function	OVP, OCP, OPP, UVP, UCP, OTP, Vsense protection
Standard Interface	Standard: USB, CAN, LAN, VCP; optional: GPIB, analog card (includes RS232), fiber optic socket
Isolation (output to ground)	500V
Working Temperature	0 ~ 50°C
Dimension (mm)	600mm(W)*917.61mm(D)*1441.41mm(H)
Weight(net)	452.8KG

Note: 1. Models without emergency stop module (i.e. AC contactor not included), other AC input voltage ranges are required for customization. Models without emergency stop module and assembled to the cabinet, with AC input voltage in the range of 198~264V, need to be customized while derating by 50%. Models with emergency stop module (including AC contactor) only support 380VAC±10% for standard AC input voltage, 480VAC±10% voltage is required for customization.

6.1.2 300V

6.1.2.1 IT6006C-300-75

Parameter		IT6006C-300-75
Rated value (0 °C-50 °C)	Output Voltage	0 ~ 300V
	Output Current	-75 ~ 75A
	Output Power	-6 ~ 6kW
	Output Resistance	0 ~ 1Ω
Line Regulation	Voltage	≤0.01%FS
±(% of Output+Offset)	Current	≤0.05%FS
Load Regulation	Voltage	≤0.02%FS
±(% of Output+Offset)	Current	≤0.05%FS
Setup Resolution	Voltage	0.01V
	Current	0.01A
	Power	0.001kW
	Resistance	0.001Ω

Parameter		IT6006C-300-75
Read Back Resolution	Voltage	0.01V
	Current	0.01A
	Power	0.001kW
	Resistance	0.001Ω
Setup Accuracy (within 12 months, 25°C ±5°C) ±(% of Output+Offset)	Voltage	≤0.02% + 0.02%FS
	Current	≤0.1% + 0.1%FS
	Power	≤0.5% + 0.5%FS
	Resistance	≤1% + 1%FS
Read Back Accuracy (within 12 months, 25°C ±5°C) ±(% of Output+Offset)	Voltage	≤0.02% + 0.02%FS
	Current	≤0.1% + 0.1%FS
	Power	≤0.5% + 0.5%FS
	Resistance	≤1% + 1%FS
Ripple (20Hz -20MHz)	Voltage	≤120mVpp(MAX:≤600mVpp)
	Current	≤0.1%FS RMS
Setup Temperature Coefficient ±(% of Output/°C+Offset)	Voltage	≤50PPM/°C
	Current	≤200PPM/°C
Read Back Temperature Coefficient ±(% of Output/°C+Offset)	Voltage	≤50PPM/°C
	Current	≤200PPM/°C
Rise Time(no load)	Voltage	≤15ms
Rise Time(full load)	Voltage	≤30ms
Fall Time(no load)	Voltage	≤30ms
Fall Time(full load)	Voltage	≤15ms
Transient Response Time	Voltage	≤2ms
AC Input	Voltage (Three- phase + PE) 1	198V ~ 264V (Power derating 50%) 342V ~ 528V
	Maximum Input Current	L1,L2/20A;L3/0A
	Maximum Input Ap- parent Power	6.6kVA
	Frequency	47Hz ~ 63Hz
Setup Stability-30min	Voltage	≤0.02%+0.02%FS

Parameter		IT6006C-300-75
±(% of Output+Offset)	Current	≤0.1% + 0.1%FS
Setup stability-8h	Voltage	≤0.02%+0.02%FS
±(% of Output+Offset)	Current	≤0.1% + 0.1%FS
Readback Stability-30min	Voltage	≤0.02%+0.02%FS
±(% of Output+Offset)	Current	≤0.1% + 0.1%FS
Readback stability-8h	Voltage	≤0.02%+0.02%FS
±(% of Output+Offset)	Current	≤0.1% + 0.1%FS
Efficiency	~ 92%	
Remote Sense Compensation Voltage	≤5V	
Command Response Time	2mS	
Power Factor	0.99	
Storage Temperature	-10°C ~ 70°C	
Protective Function	OVP, OCP, OPP, UVP, UCP, OTP, Vsense protection	
Standard Interface	Standard: USB, CAN, LAN, VCP; optional: GPIB, analog card (includes RS232), fiber optic socket	
Isolation (output to ground)	1000V	
Working Temperature	0 ~ 50°C	
Dimension (mm)	483mm(W)*801.61mm(D)*151.3mm(H)	
Weight(net)	20KG	

Note: 1. Models without emergency stop module (i.e. AC contactor not included), other AC input voltage ranges are required for customization. Models without emergency stop module and assembled to the cabinet, with AC input voltage in the range of 198~264V, need to be customized while derating by 50%. Models with emergency stop module (including AC contactor) only support 380VAC±10% for standard AC input voltage, 480VAC±10% voltage is required for customization.

6.1.2.2 IT6012C-300-150

Parameter		IT60012C-300-150
Rated value (0 °C-50 °C)	Output Voltage	0 ~ 300V
	Output Current	-150 ~ 150A
	Output Power	-12 ~ 12KW
	Output Resistance	0 ~ 1Ω
Line Regulation	Voltage	≤0.01%FS

Parameter		IT60012C-300-150
±(% of Output+Offset)	Current	≤0.05%FS
Load Regulation	Voltage	≤0.02%FS
±(% of Output+Offset)	Current	≤0.05%FS
Setup Resolution	Voltage	0.01V
	Current	0.01A
	Power	0.001kW
	Resistance	0.001Ω
Read Back Resolution	Voltage	0.01V
	Current	0.01A
	Power	0.001kW
	Resistance	0.001Ω
Setup Accuracy (within 12 months, 25°C ±5°C) ±(% of Output+Offset)	Voltage	≤0.02% + 0.02%FS
	Current	≤0.1% + 0.1%FS
	Power	≤0.5% + 0.5%FS
	Resistance	≤1% + 1%FS
Read Back Accuracy (within 12 months, 25°C ±5°C) ±(% of Output+Offset)	Voltage	≤0.02% + 0.02%FS
	Current	≤0.1% + 0.1%FS
	Power	≤0.5% + 0.5%FS
	Resistance	≤1% + 1%FS
Ripple (20Hz -20MHz)	Voltage	≤120mVpp(MAX:≤600mVpp)
	Current	≤0.1%FS RMS
Setup Temperature Coefficient	Voltage	≤50PPM/°C
±(% of Output/°C+Offset)	Current	≤200PPM/°C
Read Back Temperature Coefficient	Voltage	≤50PPM/°C
±(% of Output/°C+Offset)	Current	≤200PPM/°C
Rise Time(no load)	Voltage	≤15ms
Rise Time(full load)	Voltage	≤30ms
Fall Time(no load)	Voltage	≤30ms
Fall Time(full load)	Voltage	≤15ms
Transient Response Time	Voltage	≤2ms

Parameter		IT60012C-300-150
AC Input	Voltage (Three-phase + PE) 1	198V ~ 264V (Power derating 50%) 342V ~ 528V
	Maximum Input Current	L1,L2/20A;L3/34A
	Maximum Input Apparent Power	13.2kVA
	Frequency	47Hz ~ 63Hz
Setup Stability-30min	Voltage	$\leq 0.02\% + 0.02\%FS$
\pm (%of Output+Offset)	Current	$\leq 0.1\% + 0.1\%FS$
Setup stability-8h	Voltage	$\leq 0.02\% + 0.02\%FS$
\pm (%of Output+Offset)	Current	$\leq 0.1\% + 0.1\%FS$
Readback Stability-30min	Voltage	$\leq 0.02\% + 0.02\%FS$
\pm (%of Output+Offset)	Current	$\leq 0.1\% + 0.1\%FS$
Readback stability-8h	Voltage	$\leq 0.02\% + 0.02\%FS$
\pm (%of Output+Offset)	Current	$\leq 0.1\% + 0.1\%FS$
Efficiency	~ 92%	
Remote Sense Compensation Voltage	$\leq 5V$	
Command Response Time	2mS	
Power Factor	0.99	
Storage Temperature	$-10^{\circ}C \sim 70^{\circ}C$	
Protective Function	OVP, OCP, OPP, UVP, UCP, OTP, Vsense protection	
Standard Interface	Standard: USB, CAN, LAN, VCP; optional: GPIB, analog card (includes RS232), fiber optic socket	
Isolation (output to ground)	1000V	
Working Temperature	$0 \sim 50^{\circ}C$	
Dimension (mm)	483mm(W)*801.61mm(D)*151.3mm(H)	
Weight(net)	30KG	

Note: 1. Models without emergency stop module (i.e. AC contactor not included), other AC input voltage ranges are required for customization. Models without emergency stop module and assembled to the cabinet, with AC input voltage in the range of 198~264V, need to be customized while derating by 50%. Models with emergency stop module (including AC contactor) only support 380VAC \pm 10% for standard AC input voltage, 480VAC \pm 10% voltage is required for customization.

6.1.2.3 IT6018C-300-225

Parameter		IT6018C-300-225
Rated value (0 °C-50 °C)	Output Voltage	0 ~ 300V
	Output Current	-225 ~ 225A
	Output Power	-18 ~ 18kW
	Output Resistance	0 ~ 1Ω
Line Regulation	Voltage	≤0.01%FS
±(% of Output+Offset)	Current	≤0.05%FS
Load Regulation	Voltage	≤0.02%FS
±(% of Output+Offset)	Current	≤0.05%FS
Setup Resolution	Voltage	0.01V
	Current	0.01A
	Power	0.001kW
	Resistance	0.001Ω
Read Back Resolution	Voltage	0.01V
	Current	0.01A
	Power	0.001kW
	Resistance	0.001Ω
Setup Accuracy (within 12 months, 25°C ±5°C) ±(% of Output+Offset)	Voltage	≤0.02% + 0.02%FS
	Current	≤0.1% + 0.1%FS
	Power	≤0.5% + 0.5%FS
	Resistance	≤1% + 1%FS
Read Back Accuracy (within 12 months, 25°C ±5°C) ±(% of Output+Offset)	Voltage	≤0.02% + 0.02%FS
	Current	≤0.1% + 0.1%FS
	Power	≤0.5% + 0.5%FS
	Resistance	≤1% + 1%FS
Ripple	Voltage	≤120mVpp(MAX:≤300mVpp)
(20Hz -20MHz)	Current	≤0.1%FS RMS
Setup Temperature Coefficient	Voltage	≤50PPM/°C
±(% of Output/°C+Offset)	Current	≤200PPM/°C
Read Back Temperature Coefficient	Voltage	≤50PPM/°C

Parameter		IT6018C-300-225
±(% of Output/°C+Offset)	Current	≤200PPM/°C
Rise Time(no load)	Voltage	≤15ms
Rise Time(full load)	Voltage	≤30ms
Fall Time(no load)	Voltage	≤30ms
Fall Time(full load)	Voltage	≤15ms
Transient Response Time	Voltage	≤2ms
AC Input	Voltage (Three-phase + PE) 1	198V ~ 264V (Power derating 50%) 342V ~ 528V
	Maximum Input Current	33.37A
	Maximum Input Apparent Power	19.8kVA
	Frequency	47Hz ~ 63Hz
Setup Stability-30min	Voltage	≤0.02%+0.02%FS
±(% of Output+Offset)	Current	≤0.1% + 0.1%FS
Setup stability-8h	Voltage	≤0.02%+0.02%FS
±(% of Output+Offset)	Current	≤0.1% + 0.1%FS
Readback Stability-30min	Voltage	≤0.02%+0.02%FS
±(% of Output+Offset)	Current	≤0.1% + 0.1%FS
Readback stability-8h	Voltage	≤0.02%+0.02%FS
±(% of Output+Offset)	Current	≤0.1% + 0.1%FS
Efficiency	~ 92%	
Remote Sense Compensation Voltage	≤5V	
Command Response Time	2mS	
Power Factor	0.99	
Storage Temperature	-10°C ~ 70°C	
Protective Function	OVP, OCP, OPP, UVP, UCP, OTP, Vsense protection	
Standard Interface	Standard: USB, CAN, LAN, VCP; optional: GPIB, analog card (includes RS232), fiber optic socket	
Isolation (output to ground)	1000V	
Working Temperature	0 ~ 50°C	
Dimension (mm)	483mm(W)*801.61mm(D)*151.3mm(H)	
Weight(net)	40KG	

Parameter	IT6018C-300-225
-----------	-----------------

Note:

1. Models without emergency stop module (i.e. AC contactor not included), other AC input voltage ranges are required for customization. Models without emergency stop module and assembled to the cabinet, with AC input voltage in the range of 198~264V, need to be customized while derating by 50%. Models with emergency stop module (including AC contactor) only support 380VAC±10% for standard AC input voltage, 480VAC±10% voltage is required for customization.

6.1.2.4 IT6036C-300-450

Parameter		IT6036C-300-450
Rated value (0 °C-50 °C)	Output Voltage	0 ~ 300V
	Output Current	-450 ~ 450A
	Output Power	-36 ~ 36kW
	Output Resistance	0 ~ 1Ω
Line Regulation	Voltage	≤0.01%FS
±(%of Output+Offset)	Current	≤0.05%FS
Load Regulation	Voltage	≤0.02%FS
±(%of Output+Offset)	Current	≤0.05%FS
Setup Resolution	Voltage	0.01V
	Current	0.01A
	Power	0.001kW
	Resistance	0.001Ω
Read Back Resolution	Voltage	0.01V
	Current	0.01A
	Power	0.001kW
	Resistance	0.001Ω
Setup Accuracy (within 12 months, 25°C ±5°C) ±(%of Output+Offset)	Voltage	≤0.02% + 0.02%FS
	Current	≤0.1% + 0.1%FS
	Power	≤0.5% + 0.5%FS
	Resistance	≤1% + 1%FS
Read Back Accuracy (within 12 months, 25°C ±5°C)	Voltage	≤0.02% + 0.02%FS
	Current	≤0.1% + 0.1%FS

Parameter		IT6036C-300-450
±(% of Output+Offset)	Power	≤0.5% + 0.5%FS
	Resistance	≤1% + 1%FS
Ripple	Voltage	≤120mVpp(MAX:≤300mVpp)
(20Hz -20MHz)	Current	≤0.1%FS RMS
Setup Temperature Coefficient	Voltage	≤50PPM/°C
±(% of Output/°C+Offset)	Current	≤200PPM/°C
Read Back Temperature Coefficient	Voltage	≤50PPM/°C
±(% of Output/°C+Offset)	Current	≤200PPM/°C
Rise Time(no load)	Voltage	≤15ms
Rise Time(full load)	Voltage	≤30ms
Fall Time(no load)	Voltage	≤30ms
Fall Time(full load)	Voltage	≤15ms
Transient Response Time	Voltage	≤2ms
AC Input	Voltage (Three-phase + PE) 1	198V ~ 264V (Power derating 50%) 342V ~ 528V
	Maximum Input Current	66.73A
	Maximum Input Apparent Power	39.5kVA
	Frequency	47Hz ~ 63Hz
Setup Stability-30min	Voltage	≤0.02%+0.02%FS
±(% of Output+Offset)	Current	≤0.1% + 0.1%FS
Setup stability-8h	Voltage	≤0.02%+0.02%FS
±(% of Output+Offset)	Current	≤0.1% + 0.1%FS
Readback Stability-30min	Voltage	≤0.02%+0.02%FS
±(% of Output+Offset)	Current	≤0.1% + 0.1%FS
Readback stability-8h	Voltage	≤0.02%+0.02%FS
±(% of Output+Offset)	Current	≤0.1% + 0.1%FS
Efficiency		~ 92%
Remote Sense Compensation Voltage		≤5V
Command Response Time		2mS

Parameter	IT6036C-300-450
Power Factor	0.99
Storage Temperature	-10°C ~ 70°C
Protective Function	OVP, OCP, OPP, UVP, UCP, OTP, Vsense protection
Standard Interface	Standard: USB, CAN, LAN, VCP; optional: GPIB, analog card (includes RS232), fiber optic socket
Isolation (output to ground)	1000V
Working Temperature	0 ~ 50°C
Dimension (mm)	483mm(W)*801.61mm(D)*348.84mm(H)
Weight(net)	95KG

Note: 1. Models without emergency stop module (i.e. AC contactor not included), other AC input voltage ranges are required for customization. Models without emergency stop module and assembled to the cabinet, with AC input voltage in the range of 198~264V, need to be customized while derating by 50%. Models with emergency stop module (including AC contactor) only support 380VAC±10% for standard AC input voltage, 480VAC±10% voltage is required for customization.

6.1.2.5 IT6054C-300-675

Parameter		IT6054C-300-675
Rated value (0 °C-50 °C)	Output Voltage	0 ~ 300V
	Output Current	-675 ~ 675A
	Output Power	-54 ~ 54kW
	Output Resistance	0 ~ 1Ω
Line Regulation	Voltage	≤0.01%FS
±(%of Output+Offset)	Current	≤0.05%FS
Load Regulation	Voltage	≤0.02%FS
±(%of Output+Offset)	Current	≤0.05%FS
Setup Resolution	Voltage	0.01V
	Current	0.1A
	Power	0.001kW
	Resistance	0.001Ω
Read Back Resolution	Voltage	0.01V
	Current	0.1A
	Power	0.001kW
	Resistance	0.001Ω

Parameter		IT6054C-300-675
Setup Accuracy (within 12 months, 25°C ±5°C) ±(% of Output+Offset)	Voltage	≤0.02% + 0.02%FS
	Current	≤0.1% + 0.1%FS
	Power	≤0.5% + 0.5%FS
	Resistance	≤1% + 1%FS
Read Back Accuracy (within 12 months, 25°C ±5°C) ±(% of Output+Offset)	Voltage	≤0.02% + 0.02%FS
	Current	≤0.1% + 0.1%FS
	Power	≤0.5% + 0.5%FS
	Resistance	≤1% + 1%FS
Ripple (20Hz -20MHz)	Voltage	≤120mVpp(MAX:≤300mVpp)
	Current	≤0.1%FS RMS
Setup Temperature Coefficient ±(% of Output/°C+Offset)	Voltage	≤50PPM/°C
	Current	≤200PPM/°C
Read Back Temperature Coefficient ±(% of Output/°C+Offset)	Voltage	≤50PPM/°C
	Current	≤200PPM/°C
Rise Time(no load)	Voltage	≤15ms
Rise Time(full load)	Voltage	≤30ms
Fall Time(no load)	Voltage	≤30ms
Fall Time(full load)	Voltage	≤15ms
Transient Response Time	Voltage	≤2ms
AC Input	Voltage (Three- phase + PE) 1	198V ~ 264V (Power derating 50%) 342V ~ 528V
	Maximum Input Current	100.09A
	Maximum Input Ap- parent Power	59.3kVA
	Frequency	47Hz ~ 63Hz
Setup Stability-30min ±(% of Output+Offset)	Voltage	≤0.02%+0.02%FS
	Current	≤0.1% + 0.1%FS
Setup stability-8h ±(% of Output+Offset)	Voltage	≤0.02%+0.02%FS
	Current	≤0.1% + 0.1%FS
Readback Stability-30min	Voltage	≤0.02%+0.02%FS

Parameter		IT6054C-300-675
±(% of Output+Offset)	Current	≤0.1% + 0.1%FS
Readback stability-8h	Voltage	≤0.02%+0.02%FS
±(% of Output+Offset)	Current	≤0.1% + 0.1%FS
Efficiency		~ 92%
Remote Sense Compensation Voltage		≤5V
Command Response Time		2mS
Power Factor		0.99
Storage Temperature		-10°C ~ 70°C
Protective Function		OVP, OCP, OPP, UVP, UCP, OTP, Vsense protection
Standard Interface		Standard: USB, CAN, LAN, VCP; optional: GPIB, analog card (includes RS232), fiber optic socket
Isolation (output to ground)		1000V
Working Temperature		0 ~ 50°C
Dimension (mm)		550mm(W)*910.16mm(D)*907.64mm(H)
Weight(net)		186KG

Note: 1. Models without emergency stop module (i.e. AC contactor not included), other AC input voltage ranges are required for customization. Models without emergency stop module and assembled to the cabinet, with AC input voltage in the range of 198~264V, need to be customized while derating by 50%. Models with emergency stop module (including AC contactor) only support 380VAC±10% for standard AC input voltage, 480VAC±10% voltage is required for customization.

6.1.2.6 IT6072C-300-900

Parameter		IT6072C-300-900
Rated value (0 °C-50 °C)	Output Voltage	0 ~ 300V
	Output Current	-900 ~ 900A
	Output Power	-72 ~ 72kW
	Output Resistance	0 ~ 1Ω
Line Regulation	Voltage	≤0.01%FS
±(% of Output+Offset)	Current	≤0.05%FS
Load Regulation	Voltage	≤0.02%FS
±(% of Output+Offset)	Current	≤0.05%FS
Setup Resolution	Voltage	0.01V

Parameter		IT6072C-300-900
	Current	0.1A
	Power	0.001kW
	Resistance	0.001Ω
Read Back Resolution	Voltage	0.01V
	Current	0.1A
	Power	0.001kW
	Resistance	0.001Ω
Setup Accuracy (within 12 months, 25°C ±5°C) ±(% of Output+Offset)	Voltage	≤0.02% + 0.02%FS
	Current	≤0.1% + 0.1%FS
	Power	≤0.5% + 0.5%FS
	Resistance	≤1% + 1%FS
Read Back Accuracy (within 12 months, 25°C ±5°C) ±(% of Output+Offset)	Voltage	≤0.02% + 0.02%FS
	Current	≤0.1% + 0.1%FS
	Power	≤0.5% + 0.5%FS
	Resistance	≤1% + 1%FS
Ripple (20Hz -20MHz)	Voltage	≤120mVpp(MAX:≤300mVpp)
	Current	≤0.1%FS RMS
Setup Temperature Coefficient ±(% of Output/°C+Offset)	Voltage	≤50PPM/°C
	Current	≤200PPM/°C
Read Back Temperature Coefficient ±(% of Output/°C+Offset)	Voltage	≤50PPM/°C
	Current	≤200PPM/°C
Rise Time(no load)	Voltage	≤15ms
Rise Time(full load)	Voltage	≤30ms
Fall Time(no load)	Voltage	≤30ms
Fall Time(full load)	Voltage	≤15ms
Transient Response Time	Voltage	≤2ms
AC Input	Voltage (Three-phase + PE) 1	198V ~ 264V (Power derating 50%) 342V ~ 528V
	Maximum Input Current	133.45A
	Maximum Input Apparent Power	79.1kVA

Parameter		IT6072C-300-900
	Frequency	47Hz ~ 63Hz
Setup Stability-30min	Voltage	$\leq 0.02\% + 0.02\%FS$
\pm (% of Output+Offset)	Current	$\leq 0.1\% + 0.1\%FS$
Setup stability-8h	Voltage	$\leq 0.02\% + 0.02\%FS$
\pm (% of Output+Offset)	Current	$\leq 0.1\% + 0.1\%FS$
Readback Stability-30min	Voltage	$\leq 0.02\% + 0.02\%FS$
\pm (% of Output+Offset)	Current	$\leq 0.1\% + 0.1\%FS$
Readback stability-8h	Voltage	$\leq 0.02\% + 0.02\%FS$
\pm (% of Output+Offset)	Current	$\leq 0.1\% + 0.1\%FS$
Efficiency		~ 92%
Remote Sense Compensation Voltage		$\leq 5V$
Command Response Time		2mS
Power Factor		0.99
Storage Temperature		-10°C ~ 70°C
Protective Function		OVP, OCP, OPP, UVP, UCP, OTP, Vsense protection
Standard Interface		Standard: USB, CAN, LAN, VCP; optional: GPIB, analog card (includes RS232), fiber optic socket
Isolation (output to ground)		1000V
Working Temperature		0 ~ 50°C
Dimension (mm)		550mm(W)*910.16mm(D)*907.64mm(H)
Weight(net)		228.9KG

Note: 1. Models without emergency stop module (i.e. AC contactor not included), other AC input voltage ranges are required for customization. Models without emergency stop module and assembled to the cabinet, with AC input voltage in the range of 198~264V, need to be customized while derating by 50%. Models with emergency stop module (including AC contactor) only support 380VAC \pm 10% for standard AC input voltage, 480VAC \pm 10% voltage is required for customization.

6.1.2.7 IT6090C-300-1125

Parameter		IT6090C-300-1125
Rated value (0 °C-50 °C)	Output Voltage	0 ~ 300V
	Output Current	-1125 ~ 1125A
	Output Power	-90 ~ 90kW

Parameter		IT6090C-300-1125
	Output Resistance	0 ~ 1Ω
Line Regulation	Voltage	≤0.01%FS
±(% of Output+Offset)	Current	≤0.05%FS
Load Regulation	Voltage	≤0.02%FS
±(% of Output+Offset)	Current	≤0.05%FS
Setup Resolution	Voltage	0.01V
	Current	0.1A
	Power	0.001kW
	Resistance	0.001Ω
Read Back Resolution	Voltage	0.01V
	Current	0.1A
	Power	0.001kW
	Resistance	0.001Ω
Setup Accuracy (within 12 months, 25°C ±5°C) ±(% of Output+Offset)	Voltage	≤0.02% + 0.02%FS
	Current	≤0.1% + 0.1%FS
	Power	≤0.5% + 0.5%FS
	Resistance	≤1% + 1%FS
Read Back Accuracy (within 12 months, 25°C ±5°C) ±(% of Output+Offset)	Voltage	≤0.02% + 0.02%FS
	Current	≤0.1% + 0.1%FS
	Power	≤0.5% + 0.5%FS
	Resistance	≤1% + 1%FS
Ripple (20Hz -20MHz)	Voltage	≤120mVpp(MAX:≤300mVpp)
	Current	≤0.1%FS RMS
Setup Temperature Coefficient	Voltage	≤50PPM/°C
±(% of Output/°C+Offset)	Current	≤200PPM/°C
Read Back Temperature Coefficient	Voltage	≤50PPM/°C
±(% of Output/°C+Offset)	Current	≤200PPM/°C
Rise Time(no load)	Voltage	≤15ms
Rise Time(full load)	Voltage	≤30ms
Fall Time(no load)	Voltage	≤30ms

Parameter		IT6090C-300-1125
Fall Time(full load)	Voltage	≤15ms
Transient Response Time	Voltage	≤2ms
AC Input	Voltage (Three-phase + PE) 1	198V ~ 264V (Power derating 50%) 342V ~ 528V
	Maximum Input Current	166.81A
	Maximum Input Apparent Power	98.8kVA
	Frequency	47Hz ~ 63Hz
Setup Stability-30min	Voltage	≤0.02%+0.02%FS
±(% of Output+Offset)	Current	≤0.1% + 0.1%FS
Setup stability-8h	Voltage	≤0.02%+0.02%FS
±(% of Output+Offset)	Current	≤0.1% + 0.1%FS
Readback Stability-30min	Voltage	≤0.02%+0.02%FS
±(% of Output+Offset)	Current	≤0.1% + 0.1%FS
Readback stability-8h	Voltage	≤0.02%+0.02%FS
±(% of Output+Offset)	Current	≤0.1% + 0.1%FS
Efficiency	~ 92%	
Remote Sense Compensation Voltage	≤5V	
Command Response Time	2mS	
Power Factor	0.99	
Storage Temperature	-10°C ~ 70°C	
Protective Function	OVP, OCP, OPP, UVP, UCP, OTP, Vsense protection	
Standard Interface	Standard: USB, CAN, LAN, VCP; optional: GPIB, analog card (includes RS232), fiber optic socket	
Isolation (output to ground)	1000V	
Working Temperature	0 ~ 50°C	
Dimension (mm)	600mm(W)*917.61mm(D)*1441.41mm(H)	
Weight(net)	323.5KG	

Note: 1. Models without emergency stop module (i.e. AC contactor not included), other AC input voltage ranges are required for customization. Models without emergency stop module and assembled to the cabinet, with AC input voltage in the range of 198~264V, need to be customized while derating by 50%. Models with emergency stop module (including AC contactor) only support 380VAC±10% for standard AC input voltage, 480VAC±10% voltage is required for customization.

6.1.2.8 IT6108C-300-1350

Parameter		IT6108C-300-1350
Rated value (0 °C-50 °C)	Output Voltage	0 ~ 300V
	Output Current	-1350 ~ 1350A
	Output Power	-108 ~ 108kW
	Output Resistance	0 ~ 1Ω
Line Regulation	Voltage	≤0.01%FS
±(%of Output+Offset)	Current	≤0.05%FS
Load Regulation	Voltage	≤0.02%FS
±(%of Output+Offset)	Current	≤0.05%FS
Setup Resolution	Voltage	0.01V
	Current	0.1A
	Power	0.001kW
	Resistance	0.001Ω
Read Back Resolution	Voltage	0.01V
	Current	0.1A
	Power	0.001kW
	Resistance	0.001Ω
Setup Accuracy (within 12 months, 25°C ±5°C) ±(%of Output+Offset)	Voltage	≤0.02% + 0.02%FS
	Current	≤0.1% + 0.1%FS
	Power	≤0.5% + 0.5%FS
	Resistance	≤1% + 1%FS
Read Back Accuracy (within 12 months, 25°C ±5°C) ±(%of Output+Offset)	Voltage	≤0.02% + 0.02%FS
	Current	≤0.1% + 0.1%FS
	Power	≤0.5% + 0.5%FS
	Resistance	≤1% + 1%FS
Ripple	Voltage	≤120mVpp(MAX:≤300mVpp)
(20Hz -20MHz)	Current	≤0.1%FS RMS
Setup Temperature Coefficient	Voltage	≤50PPM/°C
±(%of Output/°C+Offset)	Current	≤200PPM/°C

Parameter		IT6108C-300-1350
Read Back Temperature Coefficient	Voltage	≤50PPM/°C
±(% of Output/°C+Offset)	Current	≤200PPM/°C
Rise Time(no load)	Voltage	≤15ms
Rise Time(full load)	Voltage	≤30ms
Fall Time(no load)	Voltage	≤30ms
Fall Time(full load)	Voltage	≤15ms
Transient Response Time	Voltage	≤2ms
AC Input	Voltage (Three-phase + PE) 1	198V ~ 264V (Power derating 50%) 342V ~ 528V
	Maximum Input Current	200.18A
	Maximum Input Apparent Power	118.6kVA
	Frequency	47Hz ~ 63Hz
Setup Stability-30min	Voltage	≤0.02%+0.02%FS
±(% of Output+Offset)	Current	≤0.1% + 0.1%FS
Setup stability-8h	Voltage	≤0.02%+0.02%FS
±(% of Output+Offset)	Current	≤0.1% + 0.1%FS
Readback Stability-30min	Voltage	≤0.02%+0.02%FS
±(% of Output+Offset)	Current	≤0.1% + 0.1%FS
Readback stability-8h	Voltage	≤0.02%+0.02%FS
±(% of Output+Offset)	Current	≤0.1% + 0.1%FS
Efficiency	~ 92%	
Remote Sense Compensation Voltage	≤5V	
Command Response Time	2mS	
Power Factor	0.99	
Storage Temperature	-10°C ~ 70°C	
Protective Function	OVP, OCP, OPP, UVP, UCP, OTP, Vsense protection	
Standard Interface	Standard: USB, CAN, LAN, VCP; optional: GPIB, analog card (includes RS232), fiber optic socket	
Isolation (output to ground)	1000V	
Working Temperature	0 ~ 50°C	

Parameter	IT6108C-300-1350
Dimension (mm)	600mm(W)*917.61mm(D)*1441.41mm(H)
Weight(net)	366.5KG

Note: 1. Models without emergency stop module (i.e. AC contactor not included), other AC input voltage ranges are required for customization. Models without emergency stop module and assembled to the cabinet, with AC input voltage in the range of 198~264V, need to be customized while derating by 50%. Models with emergency stop module (including AC contactor) only support 380VAC±10% for standard AC input voltage, 480VAC±10% voltage is required for customization.

6.1.2.9 IT6126C-300-1575

Parameter		IT6126C-300-1575
Rated value (0 °C-50 °C)	Output Voltage	0 ~ 300V
	Output Current	-1575 ~ 1575A
	Output Power	-126 ~ 126kW
	Output Resistance	0 ~ 1Ω
Line Regulation	Voltage	≤0.01%FS
±(%of Output+Offset)	Current	≤0.05%FS
Load Regulation	Voltage	≤0.02%FS
±(%of Output+Offset)	Current	≤0.05%FS
Setup Resolution	Voltage	0.01V
	Current	0.1A
	Power	0.001kW
	Resistance	0.001Ω
Read Back Resolution	Voltage	0.01V
	Current	0.1A
	Power	0.001kW
	Resistance	0.001Ω
Setup Accuracy (within 12 months, 25°C ±5°C) ±(%of Output+Offset)	Voltage	≤0.02% + 0.02%FS
	Current	≤0.1% + 0.1%FS
	Power	≤0.5% + 0.5%FS
	Resistance	≤1% + 1%FS
Read Back Accuracy	Voltage	≤0.02% + 0.02%FS

Parameter		IT6126C-300-1575
(within 12 months, 25°C ±5°C) ±(% of Output+Offset)	Current	≤0.1% + 0.1%FS
	Power	≤0.5% + 0.5%FS
	Resistance	≤1% + 1%FS
Ripple	Voltage	≤120mVpp(MAX:≤300mVpp)
(20Hz -20MHz)	Current	≤0.1%FS RMS
Setup Temperature Coefficient	Voltage	≤50PPM/°C
±(% of Output/°C+Offset)	Current	≤200PPM/°C
Read Back Temperature Coefficient	Voltage	≤50PPM/°C
±(% of Output/°C+Offset)	Current	≤200PPM/°C
Rise Time(no load)	Voltage	≤15ms
Rise Time(full load)	Voltage	≤30ms
Fall Time(no load)	Voltage	≤30ms
Fall Time(full load)	Voltage	≤15ms
Transient Response Time	Voltage	≤2ms
AC Input	Voltage (Three-phase + PE) 1	198V ~ 264V (Power derating 50%) 342V ~ 528V
	Maximum Input Current	233.54A
	Maximum Input Apparent Power	138.3kVA
	Frequency	47Hz ~ 63Hz
Setup Stability-30min	Voltage	≤0.02%+0.02%FS
±(% of Output+Offset)	Current	≤0.1% + 0.1%FS
Setup stability-8h	Voltage	≤0.02%+0.02%FS
±(% of Output+Offset)	Current	≤0.1% + 0.1%FS
Readback Stability-30min	Voltage	≤0.02%+0.02%FS
±(% of Output+Offset)	Current	≤0.1% + 0.1%FS
Readback stability-8h	Voltage	≤0.02%+0.02%FS
±(% of Output+Offset)	Current	≤0.1% + 0.1%FS
Efficiency	~ 92%	
Remote Sense Compensation Voltage	≤5V	

Parameter		IT6126C-300-1575
Command Response Time		2mS
Power Factor		0.99
Storage Temperature		-10°C ~ 70°C
Protective Function		OVP, OCP, OPP, UVP, UCP, OTP, Vsense protection
Standard Interface		Standard: USB, CAN, LAN, VCP; optional: GPIB, analog card (includes RS232), fiber optic socket
Isolation (output to ground)		1000V
Working Temperature		0 ~ 50°C
Dimension (mm)		600mm(W)*917.61mm(D)*1441.41mm(H)
Weight(net)		409.7KG

Note: 1. Models without emergency stop module (i.e. AC contactor not included), other AC input voltage ranges are required for customization. Models without emergency stop module and assembled to the cabinet, with AC input voltage in the range of 198~264V, need to be customized while derating by 50%. Models with emergency stop module (including AC contactor) only support 380VAC±10% for standard AC input voltage, 480VAC±10% voltage is required for customization.

6.1.2.10 IT6144C-300-1800

Parameter		IT6144C-300-1800
Rated value (0 °C-50 °C)	Output Voltage	0 ~ 300V
	Output Current	-1800 ~ 1800A
	Output Power	-144 ~ 144kW
	Output Resistance	0 ~ 1Ω
Line Regulation	Voltage	≤0.01%FS
±(%of Output+Offset)	Current	≤0.05%FS
Load Regulation	Voltage	≤0.02%FS
±(%of Output+Offset)	Current	≤0.05%FS
Setup Resolution	Voltage	0.01V
	Current	0.1A
	Power	0.001kW
	Resistance	0.001Ω
Read Back Resolution	Voltage	0.01V
	Current	0.1A

Parameter		IT6144C-300-1800
	Power	0.001kW
	Resistance	0.001Ω
Setup Accuracy (within 12 months, 25°C ±5°C) ±(% of Output+Offset)	Voltage	≤0.02% + 0.02%FS
	Current	≤0.1% + 0.1%FS
	Power	≤0.5% + 0.5%FS
	Resistance	≤1% + 1%FS
Read Back Accuracy (within 12 months, 25°C ±5°C) ±(% of Output+Offset)	Voltage	≤0.02% + 0.02%FS
	Current	≤0.1% + 0.1%FS
	Power	≤0.5% + 0.5%FS
	Resistance	≤1% + 1%FS
Ripple (20Hz -20MHz)	Voltage	≤120mVpp(MAX:≤300mVpp)
	Current	≤0.1%FS RMS
Setup Temperature Coefficient ±(% of Output/°C+Offset)	Voltage	≤50PPM/°C
	Current	≤200PPM/°C
Read Back Temperature Coefficient ±(% of Output/°C+Offset)	Voltage	≤50PPM/°C
	Current	≤200PPM/°C
Rise Time(no load)	Voltage	≤15ms
Rise Time(full load)	Voltage	≤30ms
Fall Time(no load)	Voltage	≤30ms
Fall Time(full load)	Voltage	≤15ms
Transient Response Time	Voltage	≤2ms
AC Input	Voltage (Three- phase + PE) 1	198V ~ 264V (Power derating 50%) 342V ~ 528V
	Maximum Input Current	266.9A
	Maximum Input Ap- parent Power	158.1kVA
	Frequency	47Hz ~ 63Hz
Setup Stability-30min ±(% of Output+Offset)	Voltage	≤0.02%+0.02%FS
	Current	≤0.1% + 0.1%FS
Setup stability-8h	Voltage	≤0.02%+0.02%FS

Parameter		IT6144C-300-1800
±(% of Output+Offset)	Current	≤0.1% + 0.1%FS
Readback Stability-30min	Voltage	≤0.02%+0.02%FS
±(% of Output+Offset)	Current	≤0.1% + 0.1%FS
Readback stability-8h	Voltage	≤0.02%+0.02%FS
±(% of Output+Offset)	Current	≤0.1% + 0.1%FS
Efficiency	~ 92%	
Remote Sense Compensation Voltage	≤5V	
Command Response Time	2mS	
Power Factor	0.99	
Storage Temperature	-10°C ~ 70°C	
Protective Function	OVP, OCP, OPP, UVP, UCP, OTP, Vsense protection	
Standard Interface	Standard: USB, CAN, LAN, VCP; optional: GPIB, analog card (includes RS232), fiber optic socket	
Isolation (output to ground)	1000V	
Working Temperature	0 ~ 50°C	
Dimension (mm)	600mm(W)*917.61mm(D)*1441.41mm(H)	
Weight(net)	452.8KG	

Note: 1. Models without emergency stop module (i.e. AC contactor not included), other AC input voltage ranges are required for customization. Models without emergency stop module and assembled to the cabinet, with AC input voltage in the range of 198~264V, need to be customized while derating by 50%. Models with emergency stop module (including AC contactor) only support 380VAC±10% for standard AC input voltage, 480VAC±10% voltage is required for customization.

6.1.3 500V

6.1.3.1 IT6006C-500-40

Parameter		IT6006C-500-40
Rated value (0 °C-50 °C)	Output Voltage	0 ~ 500V
	Output Current	-40 ~ 40A
	Output Power	-6 ~ 6kW
	Output Resistance	0 ~ 1Ω

Parameter		IT6006C-500-40
Line Regulation	Voltage	$\leq 0.01\%FS$
$\pm(\% \text{ of Output} + \text{Offset})$	Current	$\leq 0.05\%FS$
Load Regulation	Voltage	$\leq 0.02\%FS$
$\pm(\% \text{ of Output} + \text{Offset})$	Current	$\leq 0.05\%FS$
Setup Resolution	Voltage	0.01V
	Current	0.001A
	Power	0.001kW
	Resistance	0.001 Ω
Read Back Resolution	Voltage	0.01V
	Current	0.001A
	Power	0.001kW
	Resistance	0.001 Ω
Setup Accuracy (within 12 months, 25°C ±5°C) $\pm(\% \text{ of Output} + \text{Offset})$	Voltage	$\leq 0.02\% + 0.02\%FS$
	Current	$\leq 0.1\% + 0.1\%FS$
	Power	$\leq 0.5\% + 0.5\%FS$
	Resistance	$\leq 1\% + 1\%FS$
Read Back Accuracy (within 12 months, 25°C ±5°C) $\pm(\% \text{ of Output} + \text{Offset})$	Voltage	$\leq 0.02\% + 0.02\%FS$
	Current	$\leq 0.1\% + 0.1\%FS$
	Power	$\leq 0.5\% + 0.5\%FS$
	Resistance	$\leq 1\% + 1\%FS$
Ripple	Voltage	$\leq 200mV_{pp}(\text{MAX}: \leq 800mV_{pp})$
(20Hz -20MHz)	Current	$\leq 0.1\%FS \text{ RMS}$
Setup Temperature Coefficient	Voltage	$\leq 50PPM/^{\circ}C$
$\pm(\% \text{ of Output}/^{\circ}C + \text{Offset})$	Current	$\leq 200PPM/^{\circ}C$
Read Back Temperature Coefficient	Voltage	$\leq 50PPM/^{\circ}C$
$\pm(\% \text{ of Output}/^{\circ}C + \text{Offset})$	Current	$\leq 200PPM/^{\circ}C$
Rise Time(no load)	Voltage	$\leq 15ms$
Rise Time(full load)	Voltage	$\leq 30ms$
Fall Time(no load)	Voltage	$\leq 30ms$
Fall Time(full load)	Voltage	$\leq 15ms$

Parameter		IT6006C-500-40
Transient Response Time	Voltage	≤2ms
AC Input	Voltage (Three-phase + PE) 1	198V ~ 264V (Power derating 50%) 342V ~ 528V
	Maximum Input Current	L1,L2/20A;L3/0A
	Maximum Input Apparent Power	6.6kVA
	Frequency	47Hz ~ 63Hz
Setup Stability-30min	Voltage	≤0.02%+0.02%FS
±(% of Output+Offset)	Current	≤0.1% + 0.1%FS
Setup stability-8h	Voltage	≤0.02%+0.02%FS
±(% of Output+Offset)	Current	≤0.1% + 0.1%FS
Readback Stability-30min	Voltage	≤0.02%+0.02%FS
±(% of Output+Offset)	Current	≤0.1% + 0.1%FS
Readback stability-8h	Voltage	≤0.02%+0.02%FS
±(% of Output+Offset)	Current	≤0.1% + 0.1%FS
Efficiency		~ 92%
Remote Sense Compensation Voltage		≤5V
Command Response Time		2mS
Power Factor		0.99
Storage Temperature		-10°C ~ 70°C
Protective Function		OVP, OCP, OPP, UVP, UCP, OTP, Vsense protection
Standard Interface		Standard: USB, CAN, LAN, VCP; optional: GPIB, analog card (includes RS232), fiber optic socket
Isolation (output to ground)		1000V
Working Temperature		0 ~ 50°C
Dimension (mm)		483mm(W)*801.61mm(D)*151.3mm(H)
Weight(net)		20KG

Note: 1. Models without emergency stop module (i.e. AC contactor not included), other AC input voltage ranges are required for customization. Models without emergency stop module and assembled to the cabinet, with AC input voltage in the range of 198~264V, need to be customized while derating by 50%. Models with emergency stop module (including AC contactor) only support 380VAC±10% for standard AC input voltage, 480VAC±10% voltage is required for customization.

6.1.3.2 IT6012C-500-80

Parameter		IT6012C-500-80
Rated value (0 °C-50 °C)	Output Voltage	0 ~ 500V
	Output Current	-80 ~ 80A
	Output Power	-12 ~ 12kW
	Output Resistance	0 ~ 1Ω
Line Regulation	Voltage	≤0.01%FS
±(% of Output+Offset)	Current	≤0.05%FS
Load Regulation	Voltage	≤0.02%FS
±(% of Output+Offset)	Current	≤0.05%FS
Setup Resolution	Voltage	0.01V
	Current	0.01A
	Power	0.001kW
	Resistance	0.001Ω
Read Back Resolution	Voltage	0.01V
	Current	0.01A
	Power	0.001kW
	Resistance	0.001Ω
Setup Accuracy (within 12 months, 25°C ±5°C) ±(% of Output+Offset)	Voltage	≤0.02% + 0.02%FS
	Current	≤0.1% + 0.1%FS
	Power	≤0.5% + 0.5%FS
	Resistance	≤1% + 1%FS
Read Back Accuracy (within 12 months, 25°C ±5°C) ±(% of Output+Offset)	Voltage	≤0.02% + 0.02%FS
	Current	≤0.1% + 0.1%FS
	Power	≤0.5% + 0.5%FS
	Resistance	≤1% + 1%FS
Ripple	Voltage	≤200mVpp(MAX:≤800mVpp)
(20Hz -20MHz)	Current	≤0.1%FS RMS
Setup Temperature Coefficient	Voltage	≤50PPM/°C
±(% of Output/°C+Offset)	Current	≤200PPM/°C
Read Back Temperature Coefficient	Voltage	≤50PPM/°C

Parameter		IT6012C-500-80
±(% of Output/°C+Offset)	Current	≤200PPM/°C
Rise Time(no load)	Voltage	≤15ms
Rise Time(full load)	Voltage	≤30ms
Fall Time(no load)	Voltage	≤30ms
Fall Time(full load)	Voltage	≤15ms
Transient Response Time	Voltage	≤2ms
AC Input	Voltage (Three-phase + PE) 1	198V ~ 264V (Power derating 50%) 342V ~ 528V
	Maximum Input Current	L1,L2/20A;L3/34A
	Maximum Input Apparent Power	13.2kVA
	Frequency	47Hz ~ 63Hz
Setup Stability-30min	Voltage	≤0.02% + 0.02%FS
±(% of Output+Offset)	Current	≤0.1% + 0.1%FS
Setup stability-8h	Voltage	≤0.02% + 0.02%FS
±(% of Output+Offset)	Current	≤0.1% + 0.1%FS
Readback Stability-30min	Voltage	≤0.02% + 0.02%FS
±(% of Output+Offset)	Current	≤0.1% + 0.1%FS
Readback stability-8h	Voltage	≤0.02% + 0.02%FS
±(% of Output+Offset)	Current	≤0.1% + 0.1%FS
Efficiency		~ 92%
Remote Sense Compensation Voltage		≤5V
Command Response Time		2mS
Power Factor		0.99
Storage Temperature		-10°C ~ 70°C
Protective Function		OVP, OCP, OPP, UVP, UCP, OTP, Vsense protection
Standard Interface		Standard: USB, CAN, LAN, VCP; optional: GPIB, analog card (includes RS232), fiber optic socket
Isolation (output to ground)		1000V
Working Temperature		0 ~ 50°C
Dimension (mm)		483mm(W)*801.61mm(D)*151.3mm(H)
Weight(net)		30KG

Parameter	IT6012C-500-80
-----------	----------------

Note: 1. Models without emergency stop module (i.e. AC contactor not included), other AC input voltage ranges are required for customization. Models without emergency stop module and assembled to the cabinet, with AC input voltage in the range of 198~264V, need to be customized while derating by 50%. Models with emergency stop module (including AC contactor) only support 380VAC±10% for standard AC input voltage, 480VAC±10% voltage is required for customization.

6.1.3.3 IT6018C-500-120

Parameter		IT6018C-500-120
Rated value (0 °C-50 °C)	Output Voltage	0 ~ 500V
	Output Current	-120 ~ 120A
	Output Power	-18 ~ 18kW
	Output Resistance	0 ~ 1Ω
Line Regulation	Voltage	≤0.01%FS
±(%of Output+Offset)	Current	≤0.05%FS
Load Regulation	Voltage	≤0.02%FS
±(%of Output+Offset)	Current	≤0.05%FS
Setup Resolution	Voltage	0.01V
	Current	0.01A
	Power	0.001kW
	Resistance	0.001Ω
Read Back Resolution	Voltage	0.01V
	Current	0.01A
	Power	0.001kW
	Resistance	0.001Ω
Setup Accuracy (within 12 months, 25°C ±5°C) ±(%of Output+Offset)	Voltage	≤0.02% + 0.02%FS
	Current	≤0.1% + 0.1%FS
	Power	≤0.5% + 0.5%FS
	Resistance	≤1% + 1%FS
Read Back Accuracy (within 12 months, 25°C ±5°C) ±(%of Output+Offset)	Voltage	≤0.02% + 0.02%FS
	Current	≤0.1% + 0.1%FS
	Power	≤0.5% + 0.5%FS

Parameter		IT6018C-500-120
	Resistance	$\leq 1\% + 1\%FS$
Ripple	Voltage	$\leq 200mV_{pp}(MAX:500mV_{pp})$
(20Hz -20MHz)	Current	$\leq 0.1\%FS RMS$
Setup Temperature Coefficient	Voltage	$\leq 50PPM/^{\circ}C$
$\pm(\% \text{ of Output}/^{\circ}C + \text{Offset})$	Current	$\leq 200PPM/^{\circ}C$
Read Back Temperature Coefficient	Voltage	$\leq 50PPM/^{\circ}C$
$\pm(\% \text{ of Output}/^{\circ}C + \text{Offset})$	Current	$\leq 200PPM/^{\circ}C$
Rise Time(no load)	Voltage	$\leq 15ms$
Rise Time(full load)	Voltage	$\leq 30ms$
Fall Time(no load)	Voltage	$\leq 30ms$
Fall Time(full load)	Voltage	$\leq 15ms$
Transient Response Time	Voltage	$\leq 2ms$
AC Input	Voltage (Three-phase + PE) 1	198V ~ 264V (Power derating 50%) 342V ~ 528V
	Maximum Input Current	33.37A
	Maximum Input Apparent Power	19.8kVA
	Frequency	47Hz ~ 63Hz
Setup Stability-30min	Voltage	$\leq 0.02\% + 0.02\%FS$
$\pm(\% \text{ of Output} + \text{Offset})$	Current	$\leq 0.1\% + 0.1\%FS$
Setup stability-8h	Voltage	$\leq 0.02\% + 0.02\%FS$
$\pm(\% \text{ of Output} + \text{Offset})$	Current	$\leq 0.1\% + 0.1\%FS$
Readback Stability-30min	Voltage	$\leq 0.02\% + 0.02\%FS$
$\pm(\% \text{ of Output} + \text{Offset})$	Current	$\leq 0.1\% + 0.1\%FS$
Readback stability-8h	Voltage	$\leq 0.02\% + 0.02\%FS$
$\pm(\% \text{ of Output} + \text{Offset})$	Current	$\leq 0.1\% + 0.1\%FS$
Efficiency		~ 92%
Remote Sense Compensation Voltage		$\leq 5V$
Command Response Time		2mS
Power Factor		0.99
Storage Temperature		-10 $^{\circ}C$ ~ 70 $^{\circ}C$

Parameter	IT6018C-500-120
Protective Function	OVP, OCP, OPP, UVP, UCP, OTP, Vsense protection
Standard Interface	Standard: USB, CAN, LAN, VCP; optional: GPIB, analog card (includes RS232), fiber optic socket
Isolation (output to ground)	1000V
Working Temperature	0 ~ 50°C
Dimension (mm)	483mm(W)*801.61mm(D)*151.3mm(H)
Weight(net)	40KG

Note: 1. Models without emergency stop module (i.e. AC contactor not included), other AC input voltage ranges are required for customization. Models without emergency stop module and assembled to the cabinet, with AC input voltage in the range of 198~264V, need to be customized while derating by 50%. Models with emergency stop module (including AC contactor) only support 380VAC±10% for standard AC input voltage, 480VAC±10% voltage is required for customization.

6.1.3.4 IT6036C-500-240

Parameter		IT6036C-500-240
Rated value (0 °C-50 °C)	Output Voltage	0 ~ 500V
	Output Current	-240 ~ 240A
	Output Power	-36 ~ 36kW
	Output Resistance	0 ~ 1Ω
Line Regulation	Voltage	≤0.01%FS
±(% of Output+Offset)	Current	≤0.05%FS
Load Regulation	Voltage	≤0.02%FS
±(% of Output+Offset)	Current	≤0.05%FS
Setup Resolution	Voltage	0.01V
	Current	0.01A
	Power	0.001kW
	Resistance	0.001Ω
Read Back Resolution	Voltage	0.01V
	Current	0.01A
	Power	0.001kW
	Resistance	0.001Ω
Setup Accuracy	Voltage	≤0.02% + 0.02%FS

Parameter		IT6036C-500-240
(within 12 months, 25°C ±5°C) ±(%of Output+Offset)	Current	≤0.1% + 0.1%FS
	Power	≤0.5% + 0.5%FS
	Resistance	≤1% + 1%FS
Read Back Accuracy (within 12 months, 25°C ±5°C) ±(%of Output+Offset)	Voltage	≤0.02% + 0.02%FS
	Current	≤0.1% + 0.1%FS
	Power	≤0.5% + 0.5%FS
	Resistance	≤1% + 1%FS
Ripple	Voltage	≤200mVpp(MAX:500mVpp)
(20Hz -20MHz)	Current	≤0.1%FS RMS
Setup Temperature Coefficient	Voltage	≤50PPM/°C
±(%of Output/°C+Offset)	Current	≤200PPM/°C
Read Back Temperature Coefficient	Voltage	≤50PPM/°C
±(%of Output/°C+Offset)	Current	≤200PPM/°C
Rise Time(no load)	Voltage	≤15ms
Rise Time(full load)	Voltage	≤30ms
Fall Time(no load)	Voltage	≤30ms
Fall Time(full load)	Voltage	≤15ms
Transient Response Time	Voltage	≤2ms
AC Input	Voltage (Three- phase + PE) 1	198V ~ 264V (Power derating 50%) 342V ~ 528V
	Maximum Input Current	66.73A
	Maximum Input Ap- parent Power	39.5kVA
	Frequency	47Hz ~ 63Hz
Setup Stability-30min	Voltage	≤0.02% + 0.02%FS
±(%of Output+Offset)	Current	≤0.1% + 0.1%FS
Setup stability-8h	Voltage	≤0.02% + 0.02%FS
±(%of Output+Offset)	Current	≤0.1% + 0.1%FS
Readback Stability-30min	Voltage	≤0.02% + 0.02%FS
±(%of Output+Offset)	Current	≤0.1% + 0.1%FS

Parameter		IT6036C-500-240
Readback stability-8h	Voltage	$\leq 0.02\% + 0.02\%FS$
$\pm(\% \text{ of Output} + \text{Offset})$	Current	$\leq 0.1\% + 0.1\%FS$
Efficiency		~ 92%
Remote Sense Compensation Voltage		$\leq 5V$
Command Response Time		2mS
Power Factor		0.99
Storage Temperature		-10°C ~ 70°C
Protective Function		OVP, OCP, OPP, UVP, UCP, OTP, Vsense protection
Standard Interface		Standard: USB, CAN, LAN, VCP; optional: GPIB, analog card (includes RS232), fiber optic socket
Isolation (output to ground)		1000V
Working Temperature		0 ~ 50°C
Dimension (mm)		483mm(W)*801.61mm(D)*348.84mm(H)
Weight(net)		95KG

Note: 1. Models without emergency stop module (i.e. AC contactor not included), other AC input voltage ranges are required for customization. Models without emergency stop module and assembled to the cabinet, with AC input voltage in the range of 198~264V, need to be customized while derating by 50%. Models with emergency stop module (including AC contactor) only support 380VAC $\pm 10\%$ for standard AC input voltage, 480VAC $\pm 10\%$ voltage is required for customization.

6.1.3.5 IT6054C-500-360

Parameter		IT6054C-500-360
Rated value (0 °C-50 °C)	Output Voltage	0 ~ 500V
	Output Current	-360 ~ 360A
	Output Power	-54 ~ 54kW
	Output Resistance	0 ~ 1 Ω
Line Regulation	Voltage	$\leq 0.01\%FS$
$\pm(\% \text{ of Output} + \text{Offset})$	Current	$\leq 0.05\%FS$
Load Regulation	Voltage	$\leq 0.02\%FS$
$\pm(\% \text{ of Output} + \text{Offset})$	Current	$\leq 0.05\%FS$
Setup Resolution	Voltage	0.01V
	Current	0.01A

Parameter		IT6054C-500-360
	Power	0.001kW
	Resistance	0.001Ω
Read Back Resolution	Voltage	0.01V
	Current	0.01A
	Power	0.001kW
	Resistance	0.001Ω
Setup Accuracy (within 12 months, 25°C ±5°C) ±(%of Output+Offset)	Voltage	≤0.02% + 0.02%FS
	Current	≤0.1% + 0.1%FS
	Power	≤0.5% + 0.5%FS
	Resistance	≤1% + 1%FS
Read Back Accuracy (within 12 months, 25°C ±5°C) ±(%of Output+Offset)	Voltage	≤0.02% + 0.02%FS
	Current	≤0.1% + 0.1%FS
	Power	≤0.5% + 0.5%FS
	Resistance	≤1% + 1%FS
Ripple (20Hz -20MHz)	Voltage	≤200mVpp(MAX:≤500mVpp)
	Current	≤0.1%FS RMS
Setup Temperature Coefficient ±(%of Output/°C+Offset)	Voltage	≤50PPM/°C
	Current	≤200PPM/°C
Read Back Temperature Coefficient ±(%of Output/°C+Offset)	Voltage	≤50PPM/°C
	Current	≤200PPM/°C
Rise Time(no load)	Voltage	≤15ms
Rise Time(full load)	Voltage	≤30ms
Fall Time(no load)	Voltage	≤30ms
Fall Time(full load)	Voltage	≤15ms
Transient Response Time	Voltage	≤2ms
AC Input	Voltage (Three- phase + PE) 1	198V ~ 264V (Power derating 50%) 342V ~ 528V
	Maximum Input Current	100.09A
	Maximum Input Ap- parent Power	59.3kVA

Parameter		IT6054C-500-360
	Frequency	47Hz ~ 63Hz
Setup Stability-30min	Voltage	$\leq 0.02\% + 0.02\%FS$
$\pm(\% \text{ of Output} + \text{Offset})$	Current	$\leq 0.1\% + 0.1\%FS$
Setup stability-8h	Voltage	$\leq 0.02\% + 0.02\%FS$
$\pm(\% \text{ of Output} + \text{Offset})$	Current	$\leq 0.1\% + 0.1\%FS$
Readback Stability-30min	Voltage	$\leq 0.02\% + 0.02\%FS$
$\pm(\% \text{ of Output} + \text{Offset})$	Current	$\leq 0.1\% + 0.1\%FS$
Readback stability-8h	Voltage	$\leq 0.02\% + 0.02\%FS$
$\pm(\% \text{ of Output} + \text{Offset})$	Current	$\leq 0.1\% + 0.1\%FS$
Efficiency		~ 92%
Remote Sense Compensation Voltage		$\leq 5V$
Command Response Time		2mS
Power Factor		0.99
Storage Temperature		-10°C ~ 70°C
Protective Function		OVP, OCP, OPP, UVP, UCP, OTP, Vsense protection
Standard Interface		Standard: USB, CAN, LAN, VCP; optional: GPIB, analog card (includes RS232), fiber optic socket
Isolation (output to ground)		1000V
Working Temperature		0 ~ 50°C
Dimension (mm)		550mm(W)*910.16mm(D)*907.64mm(H)
Weight(net)		186KG

Note: 1. Models without emergency stop module (i.e. AC contactor not included), other AC input voltage ranges are required for customization. Models without emergency stop module and assembled to the cabinet, with AC input voltage in the range of 198~264V, need to be customized while derating by 50%. Models with emergency stop module (including AC contactor) only support 380VAC $\pm 10\%$ for standard AC input voltage, 480VAC $\pm 10\%$ voltage is required for customization.

6.1.3.6 IT6072C-500-480

Parameter		IT6072C-500-480
Rated value (0 °C-50 °C)	Output Voltage	0 ~ 500V
	Output Current	-480 ~ 480A
	Output Power	-72 ~ 72kW

Parameter		IT6072C-500-480
	Output Resistance	0 ~ 1Ω
Line Regulation	Voltage	≤0.01%FS
±(% of Output+Offset)	Current	≤0.05%FS
Load Regulation	Voltage	≤0.02%FS
±(% of Output+Offset)	Current	≤0.05%FS
Setup Resolution	Voltage	0.01V
	Current	0.01A
	Power	0.001kW
	Resistance	0.001Ω
Read Back Resolution	Voltage	0.01V
	Current	0.01A
	Power	0.001kW
	Resistance	0.001Ω
Setup Accuracy (within 12 months, 25°C ±5°C) ±(% of Output+Offset)	Voltage	≤0.02% + 0.02%FS
	Current	≤0.1% + 0.1%FS
	Power	≤0.5% + 0.5%FS
	Resistance	≤1% + 1%FS
Read Back Accuracy (within 12 months, 25°C ±5°C) ±(% of Output+Offset)	Voltage	≤0.02% + 0.02%FS
	Current	≤0.1% + 0.1%FS
	Power	≤0.5% + 0.5%FS
	Resistance	≤1% + 1%FS
Ripple	Voltage	≤200mVpp(MAX:≤500mVpp)
(20Hz -20MHz)	Current	≤0.1%FS RMS
Setup Temperature Coefficient	Voltage	≤50PPM/°C
±(% of Output/°C+Offset)	Current	≤200PPM/°C
Read Back Temperature Coefficient	Voltage	≤50PPM/°C
±(% of Output/°C+Offset)	Current	≤200PPM/°C
Rise Time(no load)	Voltage	≤15ms
Rise Time(full load)	Voltage	≤30ms
Fall Time(no load)	Voltage	≤30ms

Parameter		IT6072C-500-480
Fall Time(full load)	Voltage	≤15ms
Transient Response Time	Voltage	≤2ms
AC Input	Voltage (Three-phase + PE) 1	198V ~ 264V (Power derating 50%) 342V ~ 528V
	Maximum Input Current	133.45A
	Maximum Input Apparent Power	79.1kVA
	Frequency	47Hz ~ 63Hz
Setup Stability-30min	Voltage	≤0.02% + 0.02%FS
±(% of Output+Offset)	Current	≤0.1% + 0.1%FS
Setup stability-8h	Voltage	≤0.02% + 0.02%FS
±(% of Output+Offset)	Current	≤0.1% + 0.1%FS
Readback Stability-30min	Voltage	≤0.02% + 0.02%FS
±(% of Output+Offset)	Current	≤0.1% + 0.1%FS
Readback stability-8h	Voltage	≤0.02% + 0.02%FS
±(% of Output+Offset)	Current	≤0.1% + 0.1%FS
Efficiency	~ 92%	
Remote Sense Compensation Voltage	≤5V	
Command Response Time	2mS	
Power Factor	0.99	
Storage Temperature	-10°C ~ 70°C	
Protective Function	OVP, OCP, OPP, UVP, UCP, OTP, Vsense protection	
Standard Interface	Standard: USB, CAN, LAN, VCP; optional: GPIB, analog card (includes RS232), fiber optic socket	
Isolation (output to ground)	1000V	
Working Temperature	0 ~ 50°C	
Dimension (mm)	550mm(W)*910.16mm(D)*907.64mm(H)	
Weight(net)	228.9KG	

Note: 1. Models without emergency stop module (i.e. AC contactor not included), other AC input voltage ranges are required for customization. Models without emergency stop module and assembled to the cabinet, with AC input voltage in the range of 198~264V, need to be customized while derating by 50%. Models with emergency stop module (including AC contactor) only support 380VAC±10% for standard AC input voltage, 480VAC±10% voltage is required for customization.

6.1.3.7 IT6090C-500-600

Parameter		IT6090C-500-600
Rated value (0 °C-50 °C)	Output Voltage	0 ~ 500V
	Output Current	-600 ~ 600A
	Output Power	-90 ~ 90kW
	Output Resistance	0 ~ 1Ω
Line Regulation	Voltage	≤0.01%FS
±(% of Output+Offset)	Current	≤0.05%FS
Load Regulation	Voltage	≤0.02%FS
±(% of Output+Offset)	Current	≤0.05%FS
Setup Resolution	Voltage	0.01V
	Current	0.1A
	Power	0.001kW
	Resistance	0.001Ω
Read Back Resolution	Voltage	0.01V
	Current	0.1A
	Power	0.001kW
	Resistance	0.001Ω
Setup Accuracy (within 12 months, 25°C ±5°C) ±(% of Output+Offset)	Voltage	≤0.02% + 0.02%FS
	Current	≤0.1% + 0.1%FS
	Power	≤0.5% + 0.5%FS
	Resistance	≤1% + 1%FS
Read Back Accuracy (within 12 months, 25°C ±5°C) ±(% of Output+Offset)	Voltage	≤0.02% + 0.02%FS
	Current	≤0.1% + 0.1%FS
	Power	≤0.5% + 0.5%FS
	Resistance	≤1% + 1%FS
Ripple	Voltage	≤200mVpp(MAX:≤500mVpp)
(20Hz -20MHz)	Current	≤0.1%FS RMS
Setup Temperature Coefficient	Voltage	≤50PPM/°C
±(% of Output/°C+Offset)	Current	≤200PPM/°C

Parameter		IT6090C-500-600
Read Back Temperature Coefficient	Voltage	$\leq 50\text{PPM}/^{\circ}\text{C}$
$\pm(\% \text{ of Output}/^{\circ}\text{C} + \text{Offset})$	Current	$\leq 200\text{PPM}/^{\circ}\text{C}$
Rise Time(no load)	Voltage	$\leq 15\text{ms}$
Rise Time(full load)	Voltage	$\leq 30\text{ms}$
Fall Time(no load)	Voltage	$\leq 30\text{ms}$
Fall Time(full load)	Voltage	$\leq 15\text{ms}$
Transient Response Time	Voltage	$\leq 2\text{ms}$
AC Input	Voltage (Three-phase + PE) 1	198V ~ 264V (Power derating 50%) 342V ~ 528V
	Maximum Input Current	166.81A
	Maximum Input Apparent Power	98.8kVA
	Frequency	47Hz ~ 63Hz
Setup Stability-30min	Voltage	$\leq 0.02\% + 0.02\% \text{FS}$
$\pm(\% \text{ of Output} + \text{Offset})$	Current	$\leq 0.1\% + 0.1\% \text{FS}$
Setup stability-8h	Voltage	$\leq 0.02\% + 0.02\% \text{FS}$
$\pm(\% \text{ of Output} + \text{Offset})$	Current	$\leq 0.1\% + 0.1\% \text{FS}$
Readback Stability-30min	Voltage	$\leq 0.02\% + 0.02\% \text{FS}$
$\pm(\% \text{ of Output} + \text{Offset})$	Current	$\leq 0.1\% + 0.1\% \text{FS}$
Readback stability-8h	Voltage	$\leq 0.02\% + 0.02\% \text{FS}$
$\pm(\% \text{ of Output} + \text{Offset})$	Current	$\leq 0.1\% + 0.1\% \text{FS}$
Efficiency	~ 92%	
Remote Sense Compensation Voltage	$\leq 5\text{V}$	
Command Response Time	2mS	
Power Factor	0.99	
Storage Temperature	$-10^{\circ}\text{C} \sim 70^{\circ}\text{C}$	
Protective Function	OVP, OCP, OPP, UVP, UCP, OTP, Vsense protection	
Standard Interface	Standard: USB, CAN, LAN, VCP; optional: GPIB, analog card (includes RS232), fiber optic socket	
Isolation (output to ground)	1000V	
Working Temperature	$0 \sim 50^{\circ}\text{C}$	

Parameter	IT6090C-500-600
Dimension (mm)	600mm(W)*917.61mm(D)*1441.41mm(H)
Weight(net)	323.5KG

Note: 1. Models without emergency stop module (i.e. AC contactor not included), other AC input voltage ranges are required for customization. Models without emergency stop module and assembled to the cabinet, with AC input voltage in the range of 198~264V, need to be customized while derating by 50%. Models with emergency stop module (including AC contactor) only support 380VAC±10% for standard AC input voltage, 480VAC±10% voltage is required for customization.

6.1.3.8 IT6108C-500-720

Parameter		IT6108C-500-720
Rated value (0 °C-50 °C)	Output Voltage	0 ~ 500V
	Output Current	-720 ~ 720A
	Output Power	-108 ~ 108kW
	Output Resistance	0 ~ 1Ω
Line Regulation	Voltage	≤0.01%FS
±(% of Output+Offset)	Current	≤0.05%FS
Load Regulation	Voltage	≤0.02%FS
±(% of Output+Offset)	Current	≤0.05%FS
Setup Resolution	Voltage	0.01V
	Current	0.1A
	Power	0.001kW
	Resistance	0.001Ω
Read Back Resolution	Voltage	0.01V
	Current	0.1A
	Power	0.001kW
	Resistance	0.001Ω
Setup Accuracy (within 12 months, 25°C ±5°C) ±(% of Output+Offset)	Voltage	≤0.02% + 0.02%FS
	Current	≤0.1% + 0.1%FS
	Power	≤0.5% + 0.5%FS
	Resistance	≤1% + 1%FS
Read Back Accuracy	Voltage	≤0.02% + 0.02%FS

Parameter		IT6108C-500-720
(within 12 months, 25°C ±5°C) ±(% of Output+Offset)	Current	≤0.1% + 0.1%FS
	Power	≤0.5% + 0.5%FS
	Resistance	≤1% + 1%FS
Ripple	Voltage	≤200mVpp(MAX:≤500mVpp)
(20Hz -20MHz)	Current	≤0.1%FS RMS
Setup Temperature Coefficient	Voltage	≤50PPM/°C
±(% of Output/°C+Offset)	Current	≤200PPM/°C
Read Back Temperature Coefficient	Voltage	≤50PPM/°C
±(% of Output/°C+Offset)	Current	≤200PPM/°C
Rise Time(no load)	Voltage	≤15ms
Rise Time(full load)	Voltage	≤30ms
Fall Time(no load)	Voltage	≤30ms
Fall Time(full load)	Voltage	≤15ms
Transient Response Time	Voltage	≤2ms
AC Input	Voltage (Three-phase + PE) 1	198V ~ 264V (Power derating 50%) 342V ~ 528V
	Maximum Input Current	200.18A
	Maximum Input Apparent Power	118.6kVA
	Frequency	47Hz ~ 63Hz
Setup Stability-30min	Voltage	≤0.02% + 0.02%FS
±(% of Output+Offset)	Current	≤0.1% + 0.1%FS
Setup stability-8h	Voltage	≤0.02% + 0.02%FS
±(% of Output+Offset)	Current	≤0.1% + 0.1%FS
Readback Stability-30min	Voltage	≤0.02% + 0.02%FS
±(% of Output+Offset)	Current	≤0.1% + 0.1%FS
Readback stability-8h	Voltage	≤0.02% + 0.02%FS
±(% of Output+Offset)	Current	≤0.1% + 0.1%FS
Efficiency	~ 92%	
Remote Sense Compensation Voltage	≤5V	

Parameter	IT6108C-500-720
Command Response Time	2mS
Power Factor	0.99
Storage Temperature	-10°C ~ 70°C
Protective Function	OVP, OCP, OPP, UVP, UCP, OTP, Vsense protection
Standard Interface	Standard: USB, CAN, LAN, VCP; optional: GPIB, analog card (includes RS232), fiber optic socket
Isolation (output to ground)	1000V
Working Temperature	0 ~ 50°C
Dimension (mm)	600mm(W)*917.61mm(D)*1441.41mm(H)
Weight(net)	366.5KG

Note: 1. Models without emergency stop module (i.e. AC contactor not included), other AC input voltage ranges are required for customization. Models without emergency stop module and assembled to the cabinet, with AC input voltage in the range of 198~264V, need to be customized while derating by 50%. Models with emergency stop module (including AC contactor) only support 380VAC±10% for standard AC input voltage, 480VAC±10% voltage is required for customization.

6.1.3.9 IT6126C-500-840

Parameter		IT6126C-500-840
Rated value (0 °C-50 °C)	Output Voltage	0 ~ 500V
	Output Current	-840 ~ 840A
	Output Power	-126 ~ 126kW
	Output Resistance	0 ~ 1Ω
Line Regulation	Voltage	≤0.01%FS
±(%of Output+Offset)	Current	≤0.05%FS
Load Regulation	Voltage	≤0.02%FS
±(%of Output+Offset)	Current	≤0.05%FS
Setup Resolution	Voltage	0.01V
	Current	0.1A
	Power	0.001kW
	Resistance	0.001Ω
Read Back Resolution	Voltage	0.01V
	Current	0.1A

Parameter		IT6126C-500-840
	Power	0.001kW
	Resistance	0.001Ω
Setup Accuracy (within 12 months, 25°C ±5°C) ±(%of Output+Offset)	Voltage	≤0.02% + 0.02%FS
	Current	≤0.1% + 0.1%FS
	Power	≤0.5% + 0.5%FS
	Resistance	≤1% + 1%FS
Read Back Accuracy (within 12 months, 25°C ±5°C) ±(%of Output+Offset)	Voltage	≤0.02% + 0.02%FS
	Current	≤0.1% + 0.1%FS
	Power	≤0.5% + 0.5%FS
	Resistance	≤1% + 1%FS
Ripple (20Hz -20MHz)	Voltage	≤200mVpp(MAX:≤500mVpp)
	Current	≤0.1%FS RMS
Setup Temperature Coefficient ±(%of Output/°C+Offset)	Voltage	≤50PPM/°C
	Current	≤200PPM/°C
Read Back Temperature Coefficient ±(%of Output/°C+Offset)	Voltage	≤50PPM/°C
	Current	≤200PPM/°C
Rise Time(no load)	Voltage	≤15ms
Rise Time(full load)	Voltage	≤30ms
Fall Time(no load)	Voltage	≤30ms
Fall Time(full load)	Voltage	≤15ms
Transient Response Time	Voltage	≤2ms
AC Input	Voltage (Three- phase + PE) 1	198V ~ 264V (Power derating 50%) 342V ~ 528V
	Maximum Input Current	233.54A
	Maximum Input Ap- parent Power	138.3kVA
	Frequency	47Hz ~ 63Hz
Setup Stability-30min ±(%of Output+Offset)	Voltage	≤0.02% + 0.02%FS
	Current	≤0.1% + 0.1%FS
Setup stability-8h	Voltage	≤0.02% + 0.02%FS

Parameter		IT6126C-500-840
±(% of Output+Offset)	Current	≤0.1% + 0.1%FS
Readback Stability-30min	Voltage	≤0.02% + 0.02%FS
±(% of Output+Offset)	Current	≤0.1% + 0.1%FS
Readback stability-8h	Voltage	≤0.02% + 0.02%FS
±(% of Output+Offset)	Current	≤0.1% + 0.1%FS
Efficiency		~ 92%
Remote Sense Compensation Voltage		≤5V
Command Response Time		2mS
Power Factor		0.99
Storage Temperature		-10°C ~ 70°C
Protective Function		OVP, OCP, OPP, UVP, UCP, OTP, Vsense protection
Standard Interface		Standard: USB, CAN, LAN, VCP; optional: GPIB, analog card (includes RS232), fiber optic socket
Isolation (output to ground)		1000V
Working Temperature		0 ~ 50°C
Dimension (mm)		600mm(W)*917.61mm(D)*1441.41mm(H)
Weight(net)		409.7KG

Note: 1. Models without emergency stop module (i.e. AC contactor not included), other AC input voltage ranges are required for customization. Models without emergency stop module and assembled to the cabinet, with AC input voltage in the range of 198~264V, need to be customized while derating by 50%. Models with emergency stop module (including AC contactor) only support 380VAC±10% for standard AC input voltage, 480VAC±10% voltage is required for customization.

6.1.3.10 IT6144C-500-960

Parameter		IT6144C-500-960
Rated value (0 °C-50 °C)	Output Voltage	0 ~ 500V
	Output Current	-960 ~ 960A
	Output Power	-144 ~ 144kW
	Output Resistance	0 ~ 1Ω
Line Regulation	Voltage	≤0.01%FS
±(% of Output+Offset)	Current	≤0.05%FS
Load Regulation	Voltage	≤0.02%FS

Parameter		IT6144C-500-960
±(% of Output+Offset)	Current	≤0.05%FS
Setup Resolution	Voltage	0.01V
	Current	0.1A
	Power	0.001kW
	Resistance	0.001Ω
Read Back Resolution	Voltage	0.01V
	Current	0.1A
	Power	0.001kW
	Resistance	0.001Ω
Setup Accuracy (within 12 months, 25°C ±5°C) ±(% of Output+Offset)	Voltage	≤0.02% + 0.02%FS
	Current	≤0.1% + 0.1%FS
	Power	≤0.5% + 0.5%FS
	Resistance	≤1% + 1%FS
Read Back Accuracy (within 12 months, 25°C ±5°C) ±(% of Output+Offset)	Voltage	≤0.02% + 0.02%FS
	Current	≤0.1% + 0.1%FS
	Power	≤0.5% + 0.5%FS
	Resistance	≤1% + 1%FS
Ripple	Voltage	≤200mVpp(MAX:500mVpp)
(20Hz -20MHz)	Current	≤0.1%FS RMS
Setup Temperature Coefficient	Voltage	≤50PPM/°C
±(% of Output/°C+Offset)	Current	≤200PPM/°C
Read Back Temperature Coefficient	Voltage	≤50PPM/°C
±(% of Output/°C+Offset)	Current	≤200PPM/°C
Rise Time(no load)	Voltage	≤15ms
Rise Time(full load)	Voltage	≤30ms
Fall Time(no load)	Voltage	≤30ms
Fall Time(full load)	Voltage	≤15ms
Transient Response Time	Voltage	≤2ms
AC Input	Voltage (Three-phase + PE) 1	198V ~ 264V (Power derating 50%) 342V ~ 528V

Parameter		IT6144C-500-960
	Maximum Input Current	266.9A
	Maximum Input Apparent Power	158.1kVA
	Frequency	47Hz ~ 63Hz
Setup Stability-30min	Voltage	$\leq 0.02\% + 0.02\%FS$
\pm (% of Output+Offset)	Current	$\leq 0.1\% + 0.1\%FS$
Setup stability-8h	Voltage	$\leq 0.02\% + 0.02\%FS$
\pm (% of Output+Offset)	Current	$\leq 0.1\% + 0.1\%FS$
Readback Stability-30min	Voltage	$\leq 0.02\% + 0.02\%FS$
\pm (% of Output+Offset)	Current	$\leq 0.1\% + 0.1\%FS$
Readback stability-8h	Voltage	$\leq 0.02\% + 0.02\%FS$
\pm (% of Output+Offset)	Current	$\leq 0.1\% + 0.1\%FS$
Efficiency	~ 92%	
Remote Sense Compensation Voltage	$\leq 5V$	
Command Response Time	2mS	
Power Factor	0.99	
Storage Temperature	-10°C ~ 70°C	
Protective Function	OVP, OCP, OPP, UVP, UCP, OTP, Vsense protection	
Standard Interface	Standard: USB, CAN, LAN, VCP; optional: GPIB, analog card (includes RS232), fiber optic socket	
Isolation (output to ground)	1000V	
Working Temperature	0 ~ 50°C	
Dimension (mm)	600mm(W)*917.61mm(D)*1441.41mm(H)	
Weight(net)	452.8KG	

Note: 1. Models without emergency stop module (i.e. AC contactor not included), other AC input voltage ranges are required for customization. Models without emergency stop module and assembled to the cabinet, with AC input voltage in the range of 198~264V, need to be customized while derating by 50%. Models with emergency stop module (including AC contactor) only support 380VAC \pm 10% for standard AC input voltage, 480VAC \pm 10% voltage is required for customization.

6.1.4 800V

6.1.4.1 IT6006C-800-25

Parameter		IT6006C-800-25
Rated value (0 °C-50 °C)	Output Voltage	0 ~ 800V
	Output Current	-25 ~ 25A
	Output Power	-6 ~ 6kW
	Output Resistance	0 ~ 1Ω
Line Regulation	Voltage	≤0.01%FS
±(%of Output+Offset)	Current	≤0.05%FS
Load Regulation	Voltage	≤0.02%FS
±(%of Output+Offset)	Current	≤0.05%FS
Setup Resolution	Voltage	0.01V
	Current	0.001A
	Power	0.001kW
	Resistance	0.001Ω
Read Back Resolution	Voltage	0.01V
	Current	0.001A
	Power	0.001kW
	Resistance	0.001Ω
Setup Accuracy (within 12 months, 25°C ±5°C) ±(% of Output+Offset)	Voltage	≤0.02% + 0.02%FS
	Current	≤0.1% + 0.1%FS
	Power	≤0.5% + 0.5%FS
	Resistance	≤1% + 1%FS
Read Back Accuracy (within 12 months, 25°C ±5°C) ±(% of Output+Offset)	Voltage	≤0.02% + 0.02%FS
	Current	≤0.1% + 0.1%FS
	Power	≤0.5% + 0.5%FS
	Resistance	≤1% + 1%FS
Ripple	Voltage	≤800mVpp(MAX:≤1.2Vpp)
(20Hz -20MHz)	Current	≤0.1%FS RMS
Setup Temperature Coefficient	Voltage	≤50PPM/°C
±(%of Output/°C+Offset)	Current	≤200PPM/°C
Read Back Temperature Coefficient	Voltage	≤50PPM/°C

Parameter		IT6006C-800-25
±(% of Output/°C+Offset)	Current	≤200PPM/°C
Rise Time(no load)	Voltage	≤15ms
Rise Time(full load)	Voltage	≤30ms
Fall Time(no load)	Voltage	≤30ms
Fall Time(full load)	Voltage	≤15ms
Transient Response Time	Voltage	≤2ms
AC Input	Voltage (Three-phase + PE) 1	198V ~ 264V (Power derating 50%) 342V ~ 528V
	Maximum Input Current	L1,L2/20A;L3/0A
	Maximum Input Apparent Power	6.6kVA
	Frequency	47Hz ~ 63Hz
Setup Stability-30min	Voltage	≤0.02%+0.02%FS
±(% of Output+Offset)	Current	≤0.1% + 0.1%FS
Setup stability-8h	Voltage	≤0.02%+0.02%FS
±(% of Output+Offset)	Current	≤0.1% + 0.1%FS
Readback Stability-30min	Voltage	≤0.02%+0.02%FS
±(% of Output+Offset)	Current	≤0.1% + 0.1%FS
Readback stability-8h	Voltage	≤0.02%+0.02%FS
±(% of Output+Offset)	Current	≤0.1% + 0.1%FS
Efficiency	~ 92%	
Remote Sense Compensation Voltage	≤8V	
Command Response Time	2mS	
Power Factor	0.99	
Storage Temperature	-10°C ~ 70°C	
Protective Function	OVP, OCP, OPP, UVP, UCP, OTP, Vsense protection	
Standard Interface	Standard: USB, CAN, LAN, VCP; optional: GPIB, analog card (includes RS232), fiber optic socket	
Isolation (output to ground)	1500V	
Working Temperature	0 ~ 50°C	
Dimension (mm)	483mm(W)*801.61mm(D)*151.3mm(H)	
Weight(net)	20KG	

Parameter	IT6006C-800-25
-----------	----------------

Note: 1. Models without emergency stop module (i.e. AC contactor not included), other AC input voltage ranges are required for customization. Models without emergency stop module and assembled to the cabinet, with AC input voltage in the range of 198~264V, need to be customized while derating by 50%. Models with emergency stop module (including AC contactor) only support 380VAC±10% for standard AC input voltage, 480VAC±10% voltage is required for customization.

6.1.4.2 IT6012C-800-50

Parameter		IT6012C-800-50
Rated value (0 °C-50 °C)	Output Voltage	0 ~ 800V
	Output Current	-50 ~ 50A
	Output Power	-12 ~ 12kW
	Output Resistance	0 ~ 1Ω
Line Regulation	Voltage	≤0.01%FS
±(% of Output+Offset)	Current	≤0.05%FS
Load Regulation	Voltage	≤0.02%S
±(% of Output+Offset)	Current	≤0.05%FS
Setup Resolution	Voltage	0.01V
	Current	0.01A
	Power	0.001kW
	Resistance	0.001Ω
Read Back Resolution	Voltage	0.01V
	Current	0.01A
	Power	0.001kW
	Resistance	0.001Ω
Setup Accuracy (within 12 months, 25°C ±5°C) ±(% of Output+Offset)	Voltage	≤0.02% + 0.02%FS
	Current	≤0.1% + 0.1%FS
	Power	≤0.5% + 0.5%FS
	Resistance	≤1% + 1%FS
Read Back Accuracy (within 12 months, 25°C ±5°C) ±(% of Output+Offset)	Voltage	≤0.02% + 0.02%FS
	Current	≤0.1% + 0.1%FS
	Power	≤0.5% + 0.5%FS
	Resistance	≤1% + 1%FS
Ripple	Voltage	≤800mVpp(MAX:≤1.2Vpp)

Parameter		IT6012C-800-50
(20Hz -20MHz)	Current	≤0.1%FS RMS
Setup Temperature Coefficient	Voltage	≤50PPM/°C
±(%of Output/°C+Offset)	Current	≤200PPM/°C
Read Back Temperature Coefficient	Voltage	≤50PPM/°C
±(%of Output/°C+Offset)	Current	≤200PPM/°C
Rise Time(no load)	Voltage	≤15ms
Rise Time(full load)	Voltage	≤30ms
Fall Time(no load)	Voltage	≤30ms
Fall Time(full load)	Voltage	≤15ms
Transient Response Time	Voltage	≤2ms
AC Input	Voltage (Three-phase + PE) 1	198V ~ 264V (Power derating 50%) 342V ~ 528V
	Maximum Input Current	L1,L2/20A;L3/34A
	Maximum Input Apparent Power	13.2kVA
	Frequency	47Hz ~ 63Hz
Setup Stability-30min	Voltage	≤0.02% + 0.02%FS
±(%of Output+Offset)	Current	≤0.1% + 0.1%FS
Setup stability-8h	Voltage	≤0.02% + 0.02%FS
±(%of Output+Offset)	Current	≤0.1% + 0.1%FS
Readback Stability-30min	Voltage	≤0.02% + 0.02%FS
±(%of Output+Offset)	Current	≤0.1% + 0.1%FS
Readback stability-8h	Voltage	≤0.02% + 0.02%FS
±(%of Output+Offset)	Current	≤0.1% + 0.1%FS
Efficiency		~ 92%
Remote Sense Compensation Voltage		≤8V
Command Response Time		2mS
Power Factor		0.99
Storage Temperature		-10°C ~ 70°C
Protective Function	OVP, OCP, OPP, UVP, UCP, OTP, Vsense protection	

Parameter	IT6012C-800-50
Standard Interface	Standard: USB, CAN, LAN, VCP; optional: GPIB, analog card (includes RS232), fiber optic socket
Isolation (output to ground)	1500V
Working Temperature	0 ~ 50°C
Dimension (mm)	483mm(W)*801.61mm(D)*151.3mm(H)
Weight(net)	30KG

Note: 1. Models without emergency stop module (i.e. AC contactor not included), other AC input voltage ranges are required for customization. Models without emergency stop module and assembled to the cabinet, with AC input voltage in the range of 198~264V, need to be customized while derating by 50%. Models with emergency stop module (including AC contactor) only support 380VAC±10% for standard AC input voltage, 480VAC±10% voltage is required for customization.

6.1.4.3 IT6018C-800-75

Parameter		IT6018C-800-75
Rated value (0 °C-50 °C)	Output Voltage	0 ~ 800V
	Output Current	-75 ~ 75A
	Output Power	-18 ~ 18kW
	Output Resistance	0 ~ 1Ω
Line Regulation	Voltage	≤0.01%FS
±(%of Output+Offset)	Current	≤0.05%FS
Load Regulation	Voltage	≤0.02%FS
±(%of Output+Offset)	Current	≤0.05%FS
Setup Resolution	Voltage	0.01V
	Current	0.01A
	Power	0.001kW
	Resistance	0.001Ω
Read Back Resolution	Voltage	0.01V
	Current	0.01A
	Power	0.001kW
	Resistance	0.001Ω
Setup Accuracy (within 12 months, 25°C ±5°C) ±(% ofOutput+Offset)	Voltage	≤0.02% + 0.02%FS
	Current	≤0.1% + 0.1%FS
	Power	≤0.5% + 0.5%FS

Parameter		IT6018C-800-75
	Resistance	$\leq 1\% + 1\%FS$
Read Back Accuracy (within 12 months, 25°C $\pm 5^\circ C$) \pm (% of Output+Offset)	Voltage	$\leq 0.02\% + 0.02\%FS$
	Current	$\leq 0.1\% + 0.1\%FS$
	Power	$\leq 0.5\% + 0.5\%FS$
	Resistance	$\leq 1\% + 1\%FS$
Ripple	Voltage	$\leq 320mV_{pp}(MAX: \leq 800mV_{pp})$
(20Hz -20MHz)	Current	$\leq 0.1\%FS$ RMS
Setup Temperature Coefficient	Voltage	$\leq 50PPM/^\circ C$
\pm (%of Output/ $^\circ C$ +Offset)	Current	$\leq 200PPM/^\circ C$
Read Back Temperature Coefficient	Voltage	$\leq 50PPM/^\circ C$
\pm (%of Output/ $^\circ C$ +Offset)	Current	$\leq 200PPM/^\circ C$
Rise Time(no load)	Voltage	$\leq 15ms$
Rise Time(full load)	Voltage	$\leq 30ms$
Fall Time(no load)	Voltage	$\leq 30ms$
Fall Time(full load)	Voltage	$\leq 15ms$
Transient Response Time	Voltage	$\leq 2ms$
AC Input	Voltage (Three-phase + PE) 1	198V ~ 264V (Power derating 50%) 342V ~ 528V
	Maximum Input Current	33.37A
	Maximum Input Apparent Power	19.8kVA
	Frequency	47Hz ~ 63Hz
Setup Stability-30min	Voltage	$\leq 0.02\% + 0.02\%FS$
\pm (%of Output+Offset)	Current	$\leq 0.1\% + 0.1\%FS$
Setup stability-8h	Voltage	$\leq 0.02\% + 0.02\%FS$
\pm (%of Output+Offset)	Current	$\leq 0.1\% + 0.1\%FS$
Readback Stability-30min	Voltage	$\leq 0.02\% + 0.02\%FS$
\pm (%of Output+Offset)	Current	$\leq 0.1\% + 0.1\%FS$
Readback stability-8h	Voltage	$\leq 0.02\% + 0.02\%FS$
\pm (%of Output+Offset)	Current	$\leq 0.1\% + 0.1\%FS$
Efficiency		$\sim 92\%$

Parameter	IT6018C-800-75
Remote Sense Compensation Voltage	≤8V
Command Response Time	2mS
Power Factor	0.99
Storage Temperature	-10°C ~ 70°C
Protective Function	OVP, OCP, OPP, UVP, UCP, OTP, Vsense protection
Standard Interface	Standard: USB, CAN, LAN, VCP; optional: GPIB, analog card (includes RS232), fiber optic socket
Isolation (output to ground)	1500V
Working Temperature	0 ~ 50°C
Dimension (mm)	483mm(W)*801.61mm(D)*151.3mm(H)
Weight(net)	40kg

Note: 1. Models without emergency stop module (i.e. AC contactor not included), other AC input voltage ranges are required for customization. Models without emergency stop module and assembled to the cabinet, with AC input voltage in the range of 198~264V, need to be customized while derating by 50%. Models with emergency stop module (including AC contactor) only support 380VAC±10% for standard AC input voltage, 480VAC±10% voltage is required for customization.

6.1.4.4 IT6036C-800-150

Parameter	IT6036C-800-150	
Rated value (0 °C-50 °C)	Output Voltage	0 ~ 800V
	Output Current	-150 ~ 150A
	Output Power	-36 ~ 36kW
	Output Resistance	0 ~ 1Ω
Line Regulation	Voltage	≤0.01%FS
±(%of Output+Offset)	Current	≤0.05%FS
Load Regulation	Voltage	≤0.02%FS
±(%of Output+Offset)	Current	≤0.05%FS
Setup Resolution	Voltage	0.01V
	Current	0.01A
	Power	0.001kW
	Resistance	0.001Ω
Read Back Resolution	Voltage	0.01V

Parameter		IT6036C-800-150
	Current	0.01A
	Power	0.001kW
	Resistance	0.001Ω
Setup Accuracy (within 12 months, 25°C ±5°C) ±(% of Output+Offset)	Voltage	≤0.02% + 0.02%FS
	Current	≤0.1% + 0.1%FS
	Power	≤0.5% + 0.5%FS
	Resistance	≤1% + 1%FS
Read Back Accuracy (within 12 months, 25°C ±5°C) ±(% of Output+Offset)	Voltage	≤0.02% + 0.02%FS
	Current	≤0.1% + 0.1%FS
	Power	≤0.5% + 0.5%FS
	Resistance	≤1% + 1%FS
Ripple (20Hz -20MHz)	Voltage	≤320mVpp(MAX: ≤800mVpp)
	Current	≤0.1%FS RMS
Setup Temperature Coefficient	Voltage	≤50PPM/°C
±(% of Output/°C+Offset)	Current	≤200PPM/°C
Read Back Temperature Coefficient	Voltage	≤50PPM/°C
±(% of Output/°C+Offset)	Current	≤200PPM/°C
Rise Time(no load)	Voltage	≤15ms
Rise Time(full load)	Voltage	≤30ms
Fall Time(no load)	Voltage	≤30ms
Fall Time(full load)	Voltage	≤15ms
Transient Response Time	Voltage	≤2ms
AC Input	Voltage (Three-phase + PE) 1	198V ~ 264V (Power derating 50%) 342V ~ 528V
	Maximum Input Current	66.73A
	Maximum Input Apparent Power	39.5kVA
	Frequency	47Hz ~ 63Hz
Setup Stability-30min	Voltage	≤0.02% + 0.02%FS
±(% of Output+Offset)	Current	≤0.1% + 0.1%FS
Setup stability-8h	Voltage	≤0.02% + 0.02%FS
±(% of Output+Offset)	Current	≤0.1% + 0.1%FS

Parameter		IT6036C-800-150
Readback Stability-30min	Voltage	$\leq 0.02\% + 0.02\%FS$
\pm (%of Output+Offset)	Current	$\leq 0.1\% + 0.1\%FS$
Readback stability-8h	Voltage	$\leq 0.02\% + 0.02\%FS$
\pm (%of Output+Offset)	Current	$\leq 0.1\% + 0.1\%FS$
Efficiency		$\sim 92\%$
Remote Sense Compensation Voltage		$\leq 8V$
Command Response Time		2mS
Power Factor		0.99
Storage Temperature		$-10^{\circ}C \sim 70^{\circ}C$
Protective Function		OVP, OCP, OPP, UVP, UCP, OTP, Vsense protection
Standard Interface		Standard: USB, CAN, LAN, VCP; optional: GPIB, analog card (includes RS232), fiber optic socket
Isolation (output to ground)		1500V
Working Temperature		$0 \sim 50^{\circ}C$
Dimension (mm)		483mm(W)*801.61mm(D)*348.84mm(H)
Weight(net)		95KG

Note: 1. Models without emergency stop module (i.e. AC contactor not included), other AC input voltage ranges are required for customization. Models without emergency stop module and assembled to the cabinet, with AC input voltage in the range of 198~264V, need to be customized while derating by 50%. Models with emergency stop module (including AC contactor) only support 380VAC \pm 10% for standard AC input voltage, 480VAC \pm 10% voltage is required for customization.

6.1.4.5 IT6054C-800-225

Parameter		IT6054C-800-225
Rated value (0 °C-50 °C)	Output Voltage	0 ~ 800V
	Output Current	-225 ~ 225A
	Output Power	-54 ~ 54kW
	Output Resistance	0 ~ 1 Ω
Line Regulation	Voltage	$\leq 0.01\%FS$
\pm (%of Output+Offset)	Current	$\leq 0.05\%FS$
Load Regulation	Voltage	$\leq 0.02\%FS$
\pm (%of Output+Offset)	Current	$\leq 0.05\%FS$

Parameter		IT6054C-800-225
Setup Resolution	Voltage	0.01V
	Current	0.01A
	Power	0.001kW
	Resistance	0.001Ω
Read Back Resolution	Voltage	0.01V
	Current	0.01A
	Power	0.001kW
	Resistance	0.001Ω
Setup Accuracy (within 12 months, 25°C ±5°C) ±(% of Output+Offset)	Voltage	≤0.02% + 0.02%FS
	Current	≤0.1% + 0.1%FS
	Power	≤0.5% + 0.5%FS
	Resistance	≤1% + 1%FS
Read Back Accuracy (within 12 months, 25°C ±5°C) ±(% of Output+Offset)	Voltage	≤0.02% + 0.02%FS
	Current	≤0.1% + 0.1%FS
	Power	≤0.5% + 0.5%FS
	Resistance	≤1% + 1%FS
Ripple (20Hz -20MHz)	Voltage	≤320mVpp(MAX: ≤800mVpp)
	Current	≤0.1%FS RMS
Setup Temperature Coefficient ±(% of Output/°C+Offset)	Voltage	≤50PPM/°C
	Current	≤200PPM/°C
Read Back Temperature Coefficient ±(% of Output/°C+Offset)	Voltage	≤50PPM/°C
	Current	≤200PPM/°C
Rise Time(no load)	Voltage	≤15ms
Rise Time(full load)	Voltage	≤30ms
Fall Time(no load)	Voltage	≤30ms
Fall Time(full load)	Voltage	≤15ms
Transient Response Time	Voltage	≤2ms
AC Input	Voltage (Three-phase + PE) 1	198V ~ 264V (Power derating 50%) 342V ~ 528V
	Maximum Input Current	100.09A
	Maximum Input Apparent Power	59.3kVA

Parameter		IT6054C-800-225
	Frequency	47Hz ~ 63Hz
Setup Stability-30min	Voltage	$\leq 0.02\% + 0.02\%FS$
\pm (% of Output+Offset)	Current	$\leq 0.1\% + 0.1\%FS$
Setup stability-8h	Voltage	$\leq 0.02\% + 0.02\%FS$
\pm (% of Output+Offset)	Current	$\leq 0.1\% + 0.1\%FS$
Readback Stability-30min	Voltage	$\leq 0.02\% + 0.02\%FS$
\pm (% of Output+Offset)	Current	$\leq 0.1\% + 0.1\%FS$
Readback stability-8h	Voltage	$\leq 0.02\% + 0.02\%FS$
\pm (% of Output+Offset)	Current	$\leq 0.1\% + 0.1\%FS$
Efficiency		~ 92%
Remote Sense Compensation Voltage		$\leq 8V$
Command Response Time		2mS
Power Factor		0.99
Storage Temperature		-10°C ~ 70°C
Protective Function		OVP, OCP, OPP, UVP, UCP, OTP, Vsense protection
Standard Interface		Standard: USB, CAN, LAN, VCP; optional: GPIB, analog card (includes RS232), fiber optic socket
Isolation (output to ground)		1500V
Working Temperature		0 ~ 50°C
Dimension (mm)		550mm(W)*910.16mm(D)*907.64mm(H)
Weight(net)		186KG

Note: 1. Models without emergency stop module (i.e. AC contactor not included), other AC input voltage ranges are required for customization. Models without emergency stop module and assembled to the cabinet, with AC input voltage in the range of 198~264V, need to be customized while derating by 50%. Models with emergency stop module (including AC contactor) only support 380VAC \pm 10% for standard AC input voltage, 480VAC \pm 10% voltage is required for customization.

6.1.4.6 IT6072C-800-300

Parameter		IT6072C-800-300
Rated value (0 °C-50 °C)	Output Voltage	0 ~ 800V
	Output Current	-300 ~ 300A
	Output Power	-72 ~ 72kW

Parameter		IT6072C-800-300
	Output Resistance	0 ~ 1Ω
Line Regulation	Voltage	≤0.01%FS
±(% of Output+Offset)	Current	≤0.05%FS
Load Regulation	Voltage	≤0.02%FS
±(% of Output+Offset)	Current	≤0.05%FS
Setup Resolution	Voltage	0.01V
	Current	0.01A
	Power	0.001kW
	Resistance	0.001Ω
Read Back Resolution	Voltage	0.01V
	Current	0.01A
	Power	0.001kW
	Resistance	0.001Ω
Setup Accuracy (within 12 months, 25°C ±5°C) ±(% of Output+Offset)	Voltage	≤0.02% + 0.02%FS
	Current	≤0.1% + 0.1%FS
	Power	≤0.5% + 0.5%FS
	Resistance	≤1% + 1%FS
Read Back Accuracy (within 12 months, 25°C ±5°C) ±(% of Output+Offset)	Voltage	≤0.02% + 0.02%FS
	Current	≤0.1% + 0.1%FS
	Power	≤0.5% + 0.5%FS
	Resistance	≤1% + 1%FS
Ripple	Voltage	≤320mVpp(MAX: ≤800mVpp)
(20Hz -20MHz)	Current	≤0.1%FS RMS
Setup Temperature Coefficient	Voltage	≤50PPM/°C
±(% of Output/°C+Offset)	Current	≤200PPM/°C
Read Back Temperature Coefficient	Voltage	≤50PPM/°C
±(% of Output/°C+Offset)	Current	≤200PPM/°C
Rise Time(no load)	Voltage	≤15ms
Rise Time(full load)	Voltage	≤30ms
Fall Time(no load)	Voltage	≤30ms
Fall Time(full load)	Voltage	≤15ms
Transient Response Time	Voltage	≤2ms

Parameter		IT6072C-800-300
AC Input	Voltage (Three-phase + PE) 1	198V ~ 264V (Power derating 50%) 342V ~ 528V
	Maximum Input Current	133.45A
	Maximum Input Apparent Power	79.1kVA
	Frequency	47Hz ~ 63Hz
Setup Stability-30min	Voltage	$\leq 0.02\% + 0.02\%FS$
\pm (%of Output+Offset)	Current	$\leq 0.1\% + 0.1\%FS$
Setup stability-8h	Voltage	$\leq 0.02\% + 0.02\%FS$
\pm (%of Output+Offset)	Current	$\leq 0.1\% + 0.1\%FS$
Readback Stability-30min	Voltage	$\leq 0.02\% + 0.02\%FS$
\pm (%of Output+Offset)	Current	$\leq 0.1\% + 0.1\%FS$
Readback stability-8h	Voltage	$\leq 0.02\% + 0.02\%FS$
\pm (%of Output+Offset)	Current	$\leq 0.1\% + 0.1\%FS$
Efficiency	~ 92%	
Remote Sense Compensation Voltage	$\leq 8V$	
Command Response Time	2mS	
Power Factor	0.99	
Storage Temperature	$-10^{\circ}C \sim 70^{\circ}C$	
Protective Function	OVP, OCP, OPP, UVP, UCP, OTP, Vsense protection	
Standard Interface	Standard: USB, CAN, LAN, VCP; optional: GPIB, analog card (includes RS232), fiber optic socket	
Isolation (output to ground)	1500V	
Working Temperature	0 ~ 50°C	
Dimension (mm)	550mm(W)*910.16mm(D)*907.64mm(H)	
Weight(net)	228.9KG	

Note: 1. Models without emergency stop module (i.e. AC contactor not included), other AC input voltage ranges are required for customization. Models without emergency stop module and assembled to the cabinet, with AC input voltage in the range of 198~264V, need to be customized while derating by 50%. Models with emergency stop module (including AC contactor) only support 380VAC \pm 10% for standard AC input voltage, 480VAC \pm 10% voltage is required for customization.

6.1.4.7 IT6090C-800-375

Parameter		IT6090C-800-375
Rated value (0 °C-50 °C)	Output Voltage	0 ~ 800V
	Output Current	-375 ~ 375A
	Output Power	-90 ~ 90kW
	Output Resistance	0 ~ 1Ω
Line Regulation	Voltage	≤0.01%FS
±(% of Output+Offset)	Current	≤0.05%FS
Load Regulation	Voltage	≤0.02%FS
±(% of Output+Offset)	Current	≤0.05%FS
Setup Resolution	Voltage	0.01V
	Current	0.01A
	Power	0.001kW
	Resistance	0.001Ω
Read Back Resolution	Voltage	0.01V
	Current	0.01A
	Power	0.001kW
	Resistance	0.001Ω
Setup Accuracy (within 12 months, 25°C ±5°C) ±(% of Output+Offset)	Voltage	≤0.02% + 0.02%FS
	Current	≤0.1% + 0.1%FS
	Power	≤0.5% + 0.5%FS
	Resistance	≤1% + 1%FS
Read Back Accuracy (within 12 months, 25°C ±5°C) ±(% of Output+Offset)	Voltage	≤0.02% + 0.02%FS
	Current	≤0.1% + 0.1%FS
	Power	≤0.5% + 0.5%FS
	Resistance	≤1% + 1%FS
Ripple	Voltage	≤320mVpp(MAX: ≤800mVpp)
(20Hz -20MHz)	Current	≤0.1%FS RMS
Setup Temperature Coefficient	Voltage	≤50PPM/°C
±(% of Output/°C+Offset)	Current	≤200PPM/°C
Read Back Temperature Coefficient	Voltage	≤50PPM/°C
±(% of Output/°C+Offset)	Current	≤200PPM/°C

Parameter		IT6090C-800-375
Rise Time(no load)	Voltage	≤15ms
Rise Time(full load)	Voltage	≤30ms
Fall Time(no load)	Voltage	≤30ms
Fall Time(full load)	Voltage	≤15ms
Transient Response Time	Voltage	≤2ms
AC Input	Voltage (Three-phase + PE) 1	198V ~ 264V (Power derating 50%) 342V ~ 528V
	Maximum Input Current	166.81A
	Maximum Input Apparent Power	98.8kVA
	Frequency	47Hz ~ 63Hz
Setup Stability-30min	Voltage	≤0.02% + 0.02%FS
±(%of Output+Offset)	Current	≤0.1% + 0.1%FS
Setup stability-8h	Voltage	≤0.02% + 0.02%FS
±(%of Output+Offset)	Current	≤0.1% + 0.1%FS
Readback Stability-30min	Voltage	≤0.02% + 0.02%FS
±(%of Output+Offset)	Current	≤0.1% + 0.1%FS
Readback stability-8h	Voltage	≤0.02% + 0.02%FS
±(%of Output+Offset)	Current	≤0.1% + 0.1%FS
Efficiency		~ 92%
Remote Sense Compensation Voltage		≤8V
Command Response Time		2mS
Power Factor		0.99
Storage Temperature		-10°C ~ 70°C
Protective Function	OVP, OCP, OPP, UVP, UCP, OTP, Vsense protection	
Standard Interface	Standard: USB, CAN, LAN, VCP; optional: GPIB, analog card (includes RS232), fiber optic socket	
Isolation (output to ground)		1500V
Working Temperature		0 ~ 50°C
Dimension (mm)	600mm(W)*917.61mm(D)*1441.41mm(H)	
Weight(net)		323.5KG

Parameter	IT6090C-800-375
-----------	-----------------

Note: 1. Models without emergency stop module (i.e. AC contactor not included), other AC input voltage ranges are required for customization. Models without emergency stop module and assembled to the cabinet, with AC input voltage in the range of 198~264V, need to be customized while derating by 50%. Models with emergency stop module (including AC contactor) only support 380VAC±10% for standard AC input voltage, 480VAC±10% voltage is required for customization.

6.1.4.8 IT6108C-800-450

Parameter		IT6108C-800-450
Rated value (0 °C-50 °C)	Output Voltage	0 ~ 800V
	Output Current	-450 ~ 450A
	Output Power	-108 ~ 108kW
	Output Resistance	0 ~ 1Ω
Line Regulation	Voltage	≤0.01%FS
±(% of Output+Offset)	Current	≤0.05%FS
Load Regulation	Voltage	≤0.02%FS
±(% of Output+Offset)	Current	≤0.05%FS
Setup Resolution	Voltage	0.01V
	Current	0.01A
	Power	0.001kW
	Resistance	0.001Ω
Read Back Resolution	Voltage	0.01V
	Current	0.01A
	Power	0.001kW
	Resistance	0.001Ω
Setup Accuracy (within 12 months, 25°C ±5°C) ±(% of Output+Offset)	Voltage	≤0.02% + 0.02%FS
	Current	≤0.1% + 0.1%FS
	Power	≤0.5% + 0.5%FS
	Resistance	≤1% + 1%FS
Read Back Accuracy (within 12 months, 25°C ±5°C) ±(% of Output+Offset)	Voltage	≤0.02% + 0.02%FS
	Current	≤0.1% + 0.1%FS
	Power	≤0.5% + 0.5%FS
	Resistance	≤1% + 1%FS
Ripple	Voltage	≤320mVpp(MAX: ≤800mVpp)

Parameter		IT6108C-800-450
(20Hz -20MHz)	Current	≤0.1%FS RMS
Setup Temperature Coefficient	Voltage	≤50PPM/°C
±(%of Output/°C+Offset)	Current	≤200PPM/°C
Read Back Temperature Coefficient	Voltage	≤50PPM/°C
±(%of Output/°C+Offset)	Current	≤200PPM/°C
Rise Time(no load)	Voltage	≤15ms
Rise Time(full load)	Voltage	≤30ms
Fall Time(no load)	Voltage	≤30ms
Fall Time(full load)	Voltage	≤15ms
Transient Response Time	Voltage	≤2ms
AC Input	Voltage (Three-phase + PE) 1	198V ~ 264V (Power derating 50%) 342V ~ 528V
	Maximum Input Current	200.18A
	Maximum Input Apparent Power	118.6kVA
	Frequency	47Hz ~ 63Hz
Setup Stability-30min	Voltage	≤0.02% + 0.02%FS
±(%of Output+Offset)	Current	≤0.1% + 0.1%FS
Setup stability-8h	Voltage	≤0.02% + 0.02%FS
±(%of Output+Offset)	Current	≤0.1% + 0.1%FS
Readback Stability-30min	Voltage	≤0.02% + 0.02%FS
±(%of Output+Offset)	Current	≤0.1% + 0.1%FS
Readback stability-8h	Voltage	≤0.02% + 0.02%FS
±(%of Output+Offset)	Current	≤0.1% + 0.1%FS
Efficiency		~ 92%
Remote Sense Compensation Voltage		≤8V
Command Response Time		2mS
Power Factor		0.99
Storage Temperature		-10°C ~ 70°C
Protective Function	OVP, OCP, OPP, UVP, UCP, OTP, Vsense protection	

Parameter	IT6108C-800-450
Standard Interface	Standard: USB, CAN, LAN, VCP; optional: GPIB, analog card (includes RS232), fiber optic socket
Isolation (output to ground)	1500V
Working Temperature	0 ~ 50°C
Dimension (mm)	600mm(W)*917.61mm(D)*1441.41mm(H)
Weight(net)	366.5KG

Note: 1. Models without emergency stop module (i.e. AC contactor not included), other AC input voltage ranges are required for customization. Models without emergency stop module and assembled to the cabinet, with AC input voltage in the range of 198~264V, need to be customized while derating by 50%. Models with emergency stop module (including AC contactor) only support 380VAC±10% for standard AC input voltage, 480VAC±10% voltage is required for customization.

6.1.4.9 IT6126C-800-525

Parameter		IT6126C-800-525
Rated value (0 °C-50 °C)	Output Voltage	0 ~ 800V
	Output Current	-525 ~ 525A
	Output Power	-126 ~ 126kW
	Output Resistance	0 ~ 1Ω
Line Regulation	Voltage	≤0.01%FS
±(%of Output+Offset)	Current	≤0.05%FS
Load Regulation	Voltage	≤0.02%FS
±(%of Output+Offset)	Current	≤0.05%FS
Setup Resolution	Voltage	0.01V
	Current	0.1A
	Power	0.001kW
	Resistance	0.001Ω
Read Back Resolution	Voltage	0.01V
	Current	0.1A
	Power	0.001kW
	Resistance	0.001Ω
Setup Accuracy (within 12 months, 25°C ±5°C) ±(% ofOutput+Offset)	Voltage	≤0.02% + 0.02%FS
	Current	≤0.1% + 0.1%FS
	Power	≤0.5% + 0.5%FS

Parameter		IT6126C-800-525
	Resistance	$\leq 1\% + 1\%FS$
Read Back Accuracy (with-in 12 months, 25°C ±5°C) ±(% of Output+Offset)	Voltage	$\leq 0.02\% + 0.02\%FS$
	Current	$\leq 0.1\% + 0.1\%FS$
	Power	$\leq 0.5\% + 0.5\%FS$
	Resistance	$\leq 1\% + 1\%FS$
Ripple	Voltage	$\leq 320mVpp(MAX: \leq 800mVpp)$
(20Hz -20MHz)	Current	$\leq 0.1\%FS RMS$
Setup Temperature Coefficient	Voltage	$\leq 50PPM/^{\circ}C$
±(% of Output/ $^{\circ}C$ +Offset)	Current	$\leq 200PPM/^{\circ}C$
Read Back Temperature Coefficient	Voltage	$\leq 50PPM/^{\circ}C$
±(% of Output/ $^{\circ}C$ +Offset)	Current	$\leq 200PPM/^{\circ}C$
Rise Time(no load)	Voltage	$\leq 15ms$
Rise Time(full load)	Voltage	$\leq 30ms$
Fall Time(no load)	Voltage	$\leq 30ms$
Fall Time(full load)	Voltage	$\leq 15ms$
Transient Response Time	Voltage	$\leq 2ms$
AC Input	Voltage (Three-phase + PE) 1	198V ~ 264V (Power derating 50%) 342V ~ 528V
	Maximum Input Current	233.54A
	Maximum Input Apparent Power	138.3kVA
	Frequency	47Hz ~ 63Hz
Setup Stability-30min	Voltage	$\leq 0.02\% + 0.02\%FS$
±(% of Output+Offset)	Current	$\leq 0.1\% + 0.1\%FS$
Setup stability-8h	Voltage	$\leq 0.02\% + 0.02\%FS$
±(% of Output+Offset)	Current	$\leq 0.1\% + 0.1\%FS$
Readback Stability-30min	Voltage	$\leq 0.02\% + 0.02\%FS$
±(% of Output+Offset)	Current	$\leq 0.1\% + 0.1\%FS$
Readback stability-8h	Voltage	$\leq 0.02\% + 0.02\%FS$
±(% of Output+Offset)	Current	$\leq 0.1\% + 0.1\%FS$
Efficiency		~ 92%

Parameter	IT6126C-800-525
Remote Sense Compensation Voltage	≤8V
Command Response Time	2mS
Power Factor	0.99
Storage Temperature	-10°C ~ 70°C
Protective Function	OVP, OCP, OPP, UVP, UCP, OTP, Vsense protection
Standard Interface	Standard: USB, CAN, LAN, VCP; optional: GPIB, analog card (includes RS232), fiber optic socket
Isolation (output to ground)	1500V
Working Temperature	0 ~ 50°C
Dimension (mm)	600mm(W)*917.61mm(D)*1441.41mm(H)
Weight(net)	409.7KG

Note: 1. Models without emergency stop module (i.e. AC contactor not included), other AC input voltage ranges are required for customization. Models without emergency stop module and assembled to the cabinet, with AC input voltage in the range of 198~264V, need to be customized while derating by 50%. Models with emergency stop module (including AC contactor) only support 380VAC±10% for standard AC input voltage, 480VAC±10% voltage is required for customization.

6.1.4.10 IT6144C-800-600

Parameter	IT6144C-800-600	
Rated value (0 °C-50 °C)	Output Voltage	0 ~ 800V
	Output Current	-600 ~ 600A
	Output Power	-144 ~ 144kW
	Output Resistance	0 ~ 1Ω
Line Regulation	Voltage	≤0.01%FS
±(%of Output+Offset)	Current	≤0.05%FS
Load Regulation	Voltage	≤0.02%FS
±(%of Output+Offset)	Current	≤0.05%FS
Setup Resolution	Voltage	0.01V
	Current	0.1A
	Power	0.001kW
	Resistance	0.001Ω
Read Back Resolution	Voltage	0.01V

Parameter		IT6144C-800-600
	Current	0.1A
	Power	0.001kW
	Resistance	0.001Ω
Setup Accuracy (within 12 months, 25°C ±5°C) ±(% of Output+Offset)	Voltage	≤0.02% + 0.02%FS
	Current	≤0.1% + 0.1%FS
	Power	≤0.5% + 0.5%FS
	Resistance	≤1% + 1%FS
Read Back Accuracy (within 12 months, 25°C ±5°C) ±(% of Output+Offset)	Voltage	≤0.02% + 0.02%FS
	Current	≤0.1% + 0.1%FS
	Power	≤0.5% + 0.5%FS
	Resistance	≤1% + 1%FS
Ripple (20Hz -20MHz)	Voltage	≤320mVpp(MAX: ≤800mVpp)
	Current	≤0.1%FS RMS
Setup Temperature Coefficient	Voltage	≤50PPM/°C
±(% of Output/°C+Offset)	Current	≤200PPM/°C
Read Back Temperature Coefficient	Voltage	≤50PPM/°C
±(% of Output/°C+Offset)	Current	≤200PPM/°C
Rise Time(no load)	Voltage	≤15ms
Rise Time(full load)	Voltage	≤30ms
Fall Time(no load)	Voltage	≤30ms
Fall Time(full load)	Voltage	≤15ms
Transient Response Time	Voltage	≤2ms
AC Input	Voltage (Three-phase + PE) 1	198V ~ 264V (Power derating 50%) 342V ~ 528V
	Maximum Input Current	266.9A
	Maximum Input Apparent Power	158.1kVA
	Frequency	47Hz ~ 63Hz
Setup Stability-30min	Voltage	≤0.02% + 0.02%FS
±(% of Output+Offset)	Current	≤0.1% + 0.1%FS
Setup stability-8h	Voltage	≤0.02% + 0.02%FS
±(% of Output+Offset)	Current	≤0.1% + 0.1%FS

Parameter		IT6144C-800-600
Readback Stability-30min	Voltage	$\leq 0.02\% + 0.02\%FS$
$\pm(\% \text{ of Output} + \text{Offset})$	Current	$\leq 0.1\% + 0.1\%FS$
Readback stability-8h	Voltage	$\leq 0.02\% + 0.02\%FS$
$\pm(\% \text{ of Output} + \text{Offset})$	Current	$\leq 0.1\% + 0.1\%FS$
Efficiency	~ 92%	
Remote Sense Compensation Voltage	$\leq 8V$	
Command Response Time	2mS	
Power Factor	0.99	
Storage Temperature	$-10^{\circ}C \sim 70^{\circ}C$	
Protective Function	OVP, OCP, OPP, UVP, UCP, OTP, Vsense protection	
Standard Interface	Standard: USB, CAN, LAN, VCP; optional: GPIB, analog card (includes RS232), fiber optic socket	
Isolation (output to ground)	1500V	
Working Temperature	$0 \sim 50^{\circ}C$	
Dimension (mm)	600mm(W)*917.61mm(D)*1441.41mm(H)	
Weight(net)	452.8KG	

Note: 1. Models without emergency stop module (i.e. AC contactor not included), other AC input voltage ranges are required for customization. Models without emergency stop module and assembled to the cabinet, with AC input voltage in the range of 198~264V, need to be customized while derating by 50%. Models with emergency stop module (including AC contactor) only support 380VAC $\pm 10\%$ for standard AC input voltage, 480VAC $\pm 10\%$ voltage is required for customization.

6.1.5 1500V

6.1.5.1 IT6018C-1500-40

Parameter		IT6018C-1500-40
Rated value (0 °C-50 °C)	Output Voltage	0 ~ 1500V
	Output Current	-40 ~ 40A
	Output Power	-18 ~ 18KW
	Output Resistance	0 ~ 1 Ω
Line Regulation	Voltage	$\leq 0.01\%FS$

Parameter		IT6018C-1500-40
±(% of Output+Offset)	Current	≤0.05%FS
Load Regulation	Voltage	≤0.02%FS
±(% of Output+Offset)	Current	≤0.05%FS
Setup Resolution	Voltage	0.1V
	Current	0.001A
	Power	0.001kW
	Resistance	0.001Ω
Read Back Resolution	Voltage	0.1V
	Current	0.001A
	Power	0.001kW
	Resistance	0.001Ω
Setup Accuracy (within 12 months, 25°C ±5°C) ±(% of Output+Offset)	Voltage	≤0.02% + 0.02%FS
	Current	≤0.1% + 0.1%FS
	Power	≤0.5% + 0.5%FS
	Resistance	≤1% + 1%FS
Read Back Accuracy (within 12 months, 25°C ±5°C) ±(% of Output+Offset)	Voltage	≤0.02% + 0.02%FS
	Current	≤0.1% + 0.1%FS
	Power	≤0.5% + 0.5%FS
	Resistance	≤1% + 1%FS
Ripple	Voltage	≤600mVpp(MAX: ≤1500mVpp)
(20Hz -20MHz)	Current	≤0.1%FS RMS
Setup Temperature Coefficient	Voltage	≤50PPM/°C
±(% of Output/°C+Offset)	Current	≤200PPM/°C
Read Back Temperature Coefficient	Voltage	≤50PPM/°C
±(% of Output/°C+Offset)	Current	≤200PPM/°C
Rise Time(no load)	Voltage	≤15ms
Rise Time(full load)	Voltage	≤30ms
Fall Time(no load)	Voltage	≤30ms
Fall Time(full load)	Voltage	≤15ms
Transient Response Time	Voltage	≤2ms
AC Input	Voltage (Three-phase + PE) 1	198V ~ 264V (Power derating 50%) 342V ~ 528V

Parameter		IT6018C-1500-40
	Maximum Input Current	33.37A
	Maximum Input Apparent Power	19.8kVA
	Frequency	47Hz ~ 63Hz
Setup Stability-30min	Voltage	$\leq 0.02\% + 0.02\%FS$
\pm (%of Output+Offset)	Current	$\leq 0.1\% + 0.1\%FS$
Setup stability-8h	Voltage	$\leq 0.02\% + 0.02\%FS$
\pm (%of Output+Offset)	Current	$\leq 0.1\% + 0.1\%FS$
Readback Stability-30min	Voltage	$\leq 0.02\% + 0.02\%FS$
\pm (%of Output+Offset)	Current	$\leq 0.1\% + 0.1\%FS$
Readback stability-8h	Voltage	$\leq 0.02\% + 0.02\%FS$
\pm (%of Output+Offset)	Current	$\leq 0.1\% + 0.1\%FS$
Efficiency	~ 92%	
Remote Sense Compensation Voltage	$\leq 15V$	
Command Response Time	2mS	
Power Factor	0.99	
Storage Temperature	$-10^{\circ}C \sim 70^{\circ}C$	
Protective Function	OVP, OCP, OPP, UVP, UCP, OTP, Vsense protection	
Standard Interface	Standard: USB, CAN, LAN, VCP; optional: GPIB, analog card (includes RS232), fiber optic socket	
Isolation (output to ground)	1800V	
Working Temperature	$0 \sim 50^{\circ}C$	
Dimension (mm)	483mm(W)*801.61mm(D)*151.3mm(H)	
Weight(net)	40KG	

Note: 1. Models without emergency stop module (i.e. AC contactor not included), other AC input voltage ranges are required for customization. Models without emergency stop module and assembled to the cabinet, with AC input voltage in the range of 198~264V, need to be customized while derating by 50%. Models with emergency stop module (including AC contactor) only support 380VAC \pm 10% for standard AC input voltage, 480VAC \pm 10% voltage is required for customization.

6.1.5.2 IT6036C-1500-80

Parameter		IT6036C-1500-80
Rated value (0 °C-50 °C)	Output Voltage	0 ~ 1500V
	Output Current	-80 ~ 80A
	Output Power	-36 ~ 36KW
	Output Resistance	0 ~ 1Ω
Line Regulation	Voltage	≤0.01%FS
±(% of Output+Offset)	Current	≤0.05%FS
Load Regulation	Voltage	≤0.02%FS
±(% of Output+Offset)	Current	≤0.05%FS
Setup Resolution	Voltage	0.1V
	Current	0.01A
	Power	0.001kW
	Resistance	0.001Ω
Read Back Resolution	Voltage	0.1V
	Current	0.01A
	Power	0.001kW
	Resistance	0.001Ω
Setup Accuracy (within 12 months, 25°C ±5°C) ±(% of Output+Offset)	Voltage	≤0.02% + 0.02%FS
	Current	≤0.1% + 0.1%FS
	Power	≤0.5% + 0.5%FS
	Resistance	≤1% + 1%FS
Read Back Accuracy (within 12 months, 25°C ±5°C) ±(% of Output+Offset)	Voltage	≤0.02% + 0.02%FS
	Current	≤0.1% + 0.1%FS
	Power	≤0.5% + 0.5%FS
	Resistance	≤1% + 1%FS
Ripple	Voltage	≤600mVpp(MAX: ≤1500mVpp)
(20Hz -20MHz)	Current	≤0.1%FS RMS
Setup Temperature Coefficient	Voltage	≤50PPM/°C
±(% of Output/°C+Offset)	Current	≤200PPM/°C
Read Back Temperature Coefficient	Voltage	≤50PPM/°C
±(% of Output/°C+Offset)	Current	≤200PPM/°C

Parameter		IT6036C-1500-80
Rise Time(no load)	Voltage	≤15ms
Rise Time(full load)	Voltage	≤30ms
Fall Time(no load)	Voltage	≤30ms
Fall Time(full load)	Voltage	≤15ms
Transient Response Time	Voltage	≤2ms
AC Input	Voltage (Three-phase + PE) 1	198V ~ 264V (Power derating 50%) 342V ~ 528V
	Maximum Input Current	66.73A
	Maximum Input Apparent Power	39.5kVA
	Frequency	47Hz ~ 63Hz
Setup Stability-30min	Voltage	≤0.02% + 0.02%FS
±(%of Output+Offset)	Current	≤0.1% + 0.1%FS
Setup stability-8h	Voltage	≤0.02% + 0.02%FS
±(%of Output+Offset)	Current	≤0.1% + 0.1%FS
Readback Stability-30min	Voltage	≤0.02% + 0.02%FS
±(%of Output+Offset)	Current	≤0.1% + 0.1%FS
Readback stability-8h	Voltage	≤0.02% + 0.02%FS
±(%of Output+Offset)	Current	≤0.1% + 0.1%FS
Efficiency		~ 92%
Remote Sense Compensation Voltage		≤15V
Command Response Time		2mS
Power Factor		0.99
Storage Temperature		-10°C ~ 70°C
Protective Function	OVP, OCP, OPP, UVP, UCP, OTP, Vsense protection	
Standard Interface	Standard: USB, CAN, LAN, VCP; optional: GPIB, analog card (includes RS232), fiber optic socket	
Isolation (output to ground)		1800V
Working Temperature		0 ~ 50°C
Dimension (mm)	483mm(W)*801.61mm(D)*348.84mm(H)	
Weight(net)		95KG

Parameter	IT6036C-1500-80
-----------	-----------------

Note: 1. Models without emergency stop module (i.e. AC contactor not included), other AC input voltage ranges are required for customization. Models without emergency stop module and assembled to the cabinet, with AC input voltage in the range of 198~264V, need to be customized while derating by 50%. Models with emergency stop module (including AC contactor) only support 380VAC±10% for standard AC input voltage, 480VAC±10% voltage is required for customization.

6.1.5.3 IT6054C-1500-120

Parameter		IT6054C-1500-120
Rated value (0 °C-50 °C)	Output Voltage	0 ~ 1500V
	Output Current	-120 ~ 120A
	Output Power	-54 ~ 54KW
	Output Resistance	0 ~ 1Ω
Line Regulation	Voltage	≤0.01%FS
±(%of Output+Offset)	Current	≤0.05%FS
Load Regulation	Voltage	≤0.02%FS
±(%of Output+Offset)	Current	≤0.05%FS
Setup Resolution	Voltage	0.1V
	Current	0.01A
	Power	0.001kW
	Resistance	0.001Ω
Read Back Resolution	Voltage	0.1V
	Current	0.01A
	Power	0.001kW
	Resistance	0.001Ω
Setup Accuracy (within 12 months, 25°C ±5°C) ±(%of Output+Offset)	Voltage	≤0.02% + 0.02%FS
	Current	≤0.1% + 0.1%FS
	Power	≤0.5% + 0.5%FS
	Resistance	≤1% + 1%FS
Read Back Accuracy (within 12 months, 25°C ±5°C) ±(%of Output+Offset)	Voltage	≤0.02% + 0.02%FS
	Current	≤0.1% + 0.1%FS
	Power	≤0.5% + 0.5%FS

Parameter		IT6054C-1500-120
	Resistance	$\leq 1\% + 1\%FS$
Ripple	Voltage	$\leq 600mV_{pp}(MAX: \leq 1500mV_{pp})$
(20Hz -20MHz)	Current	$\leq 0.1\%FS RMS$
Setup Temperature Coefficient	Voltage	$\leq 50PPM/^{\circ}C$
$\pm(\%of Output/^{\circ}C+Offset)$	Current	$\leq 200PPM/^{\circ}C$
Read Back Temperature Coefficient	Voltage	$\leq 50PPM/^{\circ}C$
$\pm(\%of Output/^{\circ}C+Offset)$	Current	$\leq 200PPM/^{\circ}C$
Rise Time(no load)	Voltage	$\leq 15ms$
Rise Time(full load)	Voltage	$\leq 30ms$
Fall Time(no load)	Voltage	$\leq 30ms$
Fall Time(full load)	Voltage	$\leq 15ms$
Transient Response Time	Voltage	$\leq 2ms$
AC Input	Voltage (Three-phase + PE) 1	198V ~ 264V (Power derating 50%) 342V ~ 528V
	Maximum Input Current	100.09A
	Maximum Input Apparent Power	59.3kVA
	Frequency	47Hz ~ 63Hz
Setup Stability-30min	Voltage	$\leq 0.02\% + 0.02\%FS$
$\pm(\%of Output+Offset)$	Current	$\leq 0.1\% + 0.1\%FS$
Setup stability-8h	Voltage	$\leq 0.02\% + 0.02\%FS$
$\pm(\%of Output+Offset)$	Current	$\leq 0.1\% + 0.1\%FS$
Readback Stability-30min	Voltage	$\leq 0.02\% + 0.02\%FS$
$\pm(\%of Output+Offset)$	Current	$\leq 0.1\% + 0.1\%FS$
Readback stability-8h	Voltage	$\leq 0.02\% + 0.02\%FS$
$\pm(\%of Output+Offset)$	Current	$\leq 0.1\% + 0.1\%FS$
Efficiency		$\sim 92\%$
Remote Sense Compensation Voltage		$\leq 15V$
Command Response Time		2mS
Power Factor		0.99
Storage Temperature		$-10^{\circ}C \sim 70^{\circ}C$

Parameter	IT6054C-1500-120
Protective Function	OVP, OCP, OPP, UVP, UCP, OTP, Vsense protection
Standard Interface	Standard: USB, CAN, LAN, VCP; optional: GPIB, analog card (includes RS232), fiber optic socket
Isolation (output to ground)	1800V
Working Temperature	0 ~ 50°C
Dimension (mm)	550mm(W)*910.16mm(D)*907.64mm(H)
Weight(net)	186KG

Note:

1. Models without emergency stop module (i.e. AC contactor not included), other AC input voltage ranges are required for customization. Models without emergency stop module and assembled to the cabinet, with AC input voltage in the range of 198~264V, need to be customized while derating by 50%. Models with emergency stop module (including AC contactor) only support 380VAC±10% for standard AC input voltage, 480VAC±10% voltage is required for customization.

6.1.5.4 IT6072C-1500-160

Parameter	IT6072C-1500-160	
Rated value (0 °C-50 °C)	Output Voltage	0 ~ 1500V
	Output Current	-160 ~ 160A
	Output Power	-72 ~ 72KW
	Output Resistance	0 ~ 1Ω
Line Regulation	Voltage	≤0.01%FS
±(%of Output+Offset)	Current	≤0.05%FS
Load Regulation	Voltage	≤0.02%FS
±(%of Output+Offset)	Current	≤0.05%FS
Setup Resolution	Voltage	0.1V
	Current	0.01A
	Power	0.001kW
	Resistance	0.001Ω
Read Back Resolution	Voltage	0.1V
	Current	0.01A
	Power	0.001kW
	Resistance	0.001Ω

Parameter		IT6072C-1500-160
Setup Accuracy (within 12 months, 25°C ±5°C) ±(% of Output+Offset)	Voltage	≤0.02% + 0.02%FS
	Current	≤0.1% + 0.1%FS
	Power	≤0.5% + 0.5%FS
	Resistance	≤1% + 1%FS
Read Back Accuracy (within 12 months, 25°C ±5°C) ±(% of Output+Offset)	Voltage	≤0.02% + 0.02%FS
	Current	≤0.1% + 0.1%FS
	Power	≤0.5% + 0.5%FS
	Resistance	≤1% + 1%FS
Ripple (20Hz -20MHz)	Voltage	≤600mVpp(MAX: ≤1500mVpp)
	Current	≤0.1%FS RMS
Setup Temperature Coefficient ±(% of Output/°C+Offset)	Voltage	≤50PPM/°C
	Current	≤200PPM/°C
Read Back Temperature Coefficient ±(% of Output/°C+Offset)	Voltage	≤50PPM/°C
	Current	≤200PPM/°C
Rise Time(no load)	Voltage	≤15ms
Rise Time(full load)	Voltage	≤30ms
Fall Time(no load)	Voltage	≤30ms
Fall Time(full load)	Voltage	≤15ms
Transient Response Time	Voltage	≤2ms
AC Input	Voltage (Three-phase + PE) 1	198V ~ 264V (Power derating 50%) 342V ~ 528V
	Maximum Input Current	133.45A
	Maximum Input Apparent Power	79.1kVA
	Frequency	47Hz ~ 63Hz
Setup Stability-30min ±(% of Output+Offset)	Voltage	≤0.02% + 0.02%FS
	Current	≤0.1% + 0.1%FS
Setup stability-8h ±(% of Output+Offset)	Voltage	≤0.02% + 0.02%FS
	Current	≤0.1% + 0.1%FS
Readback Stability-30min ±(% of Output+Offset)	Voltage	≤0.02% + 0.02%FS
	Current	≤0.1% + 0.1%FS

Parameter		IT6072C-1500-160
Readback stability-8h	Voltage	$\leq 0.02\% + 0.02\%FS$
$\pm(\% \text{ of Output} + \text{Offset})$	Current	$\leq 0.1\% + 0.1\%FS$
Efficiency		~ 92%
Remote Sense Compensation Voltage		$\leq 15V$
Command Response Time		2mS
Power Factor		0.99
Storage Temperature		-10°C ~ 70°C
Protective Function		OVP, OCP, OPP, UVP, UCP, OTP, Vsense protection
Standard Interface		Standard: USB, CAN, LAN, VCP; optional: GPIB, analog card (includes RS232), fiber optic socket
Isolation (output to ground)		1800V
Working Temperature		0 ~ 50°C
Dimension (mm)		550mm(W)*910.16mm(D)*907.64mm(H)
Weight(net)		228.9KG

Note: 1. Models without emergency stop module (i.e. AC contactor not included), other AC input voltage ranges are required for customization. Models without emergency stop module and assembled to the cabinet, with AC input voltage in the range of 198~264V, need to be customized while derating by 50%. Models with emergency stop module (including AC contactor) only support 380VAC $\pm 10\%$ for standard AC input voltage, 480VAC $\pm 10\%$ voltage is required for customization.

6.1.5.5 IT6090C-1500-200

Parameter		IT6090C-1500-200
Rated value (0 °C-50 °C)	Output Voltage	0 ~ 1500V
	Output Current	-200 ~ 200A
	Output Power	-90 ~ 90kW
	Output Resistance	0 ~ 1Ω
Line Regulation	Voltage	$\leq 0.01\%FS$
$\pm(\% \text{ of Output} + \text{Offset})$	Current	$\leq 0.05\%FS$
Load Regulation	Voltage	$\leq 0.02\%FS$
$\pm(\% \text{ of Output} + \text{Offset})$	Current	$\leq 0.05\%FS$
Setup Resolution	Voltage	0.1V
	Current	0.01A

Parameter		IT6090C-1500-200
	Power	0.001kW
	Resistance	0.001Ω
Read Back Resolution	Voltage	0.1V
	Current	0.01A
	Power	0.001kW
	Resistance	0.001Ω
Setup Accuracy (within 12 months, 25°C ±5°C) ±(% of Output+Offset)	Voltage	≤0.02% + 0.02%FS
	Current	≤0.1% + 0.1%FS
	Power	≤0.5% + 0.5%FS
	Resistance	≤1% + 1%FS
Read Back Accuracy (within 12 months, 25°C ±5°C) ±(% of Output+Offset)	Voltage	≤0.02% + 0.02%FS
	Current	≤0.1% + 0.1%FS
	Power	≤0.5% + 0.5%FS
	Resistance	≤1% + 1%FS
Ripple	Voltage	≤600mVpp(MAX: ≤1500mVpp)
(20Hz -20MHz)	Current	≤0.1%FS RMS
Setup Temperature Coefficient	Voltage	≤50PPM/°C
±(% of Output/°C+Offset)	Current	≤200PPM/°C
Read Back Temperature Coefficient	Voltage	≤50PPM/°C
±(% of Output/°C+Offset)	Current	≤200PPM/°C
Rise Time(no load)	Voltage	≤15ms
Rise Time(full load)	Voltage	≤30ms
Fall Time(no load)	Voltage	≤30ms
Fall Time(full load)	Voltage	≤15ms
Transient Response Time	Voltage	≤2ms
AC Input	Voltage (Three-phase + PE) 1	198V ~ 264V (Power derating 50%) 342V ~ 528V
	Maximum Input Current	166.81A
	Maximum Input Apparent Power	98.8kVA

Parameter		IT6090C-1500-200
	Frequency	47Hz ~ 63Hz
Setup Stability-30min	Voltage	$\leq 0.02\% + 0.02\%FS$
$\pm(\% \text{ of Output} + \text{Offset})$	Current	$\leq 0.1\% + 0.1\%FS$
Setup stability-8h	Voltage	$\leq 0.02\% + 0.02\%FS$
$\pm(\% \text{ of Output} + \text{Offset})$	Current	$\leq 0.1\% + 0.1\%FS$
Readback Stability-30min	Voltage	$\leq 0.02\% + 0.02\%FS$
$\pm(\% \text{ of Output} + \text{Offset})$	Current	$\leq 0.1\% + 0.1\%FS$
Readback stability-8h	Voltage	$\leq 0.02\% + 0.02\%FS$
$\pm(\% \text{ of Output} + \text{Offset})$	Current	$\leq 0.1\% + 0.1\%FS$
Efficiency		~ 92%
Remote Sense Compensation Voltage		$\leq 15V$
Command Response Time		2mS
Power Factor		0.99
Storage Temperature		$-10^{\circ}C \sim 70^{\circ}C$
Protective Function		OVP, OCP, OPP, UVP, UCP, OTP, Vsense protection
Standard Interface		Standard: USB, CAN, LAN, VCP; optional: GPIB, analog card (includes RS232), fiber optic socket
Isolation (output to ground)		1800V
Working Temperature		$0 \sim 50^{\circ}C$
Dimension (mm)		600mm(W)*917.61mm(D)*1441.41mm(H)
Weight(net)		323.5KG

Note:

1. Models without emergency stop module (i.e. AC contactor not included), other AC input voltage ranges are required for customization. Models without emergency stop module and assembled to the cabinet, with AC input voltage in the range of 198~264V, need to be customized while derating by 50%. Models with emergency stop module (including AC contactor) only support 380VAC $\pm 10\%$ for standard AC input voltage, 480VAC $\pm 10\%$ voltage is required for customization.

6.1.5.6 IT6108C-1500-240

Parameter		IT6108C-1500-240
Rated value (0 °C-50 °C)	Output Voltage	0 ~ 1500V

Parameter		IT6108C-1500-240
	Output Current	-240 ~ 240A
	Output Power	-108 ~ 108kW
	Output Resistance	0 ~ 1Ω
Line Regulation	Voltage	≤0.01%FS
±(% of Output+Offset)	Current	≤0.05%FS
Load Regulation	Voltage	≤0.02%FS
±(% of Output+Offset)	Current	≤0.05%FS
Setup Resolution	Voltage	0.1V
	Current	0.01A
	Power	0.001kW
	Resistance	0.001Ω
Read Back Resolution	Voltage	0.1V
	Current	0.01A
	Power	0.001kW
	Resistance	0.001Ω
Setup Accuracy (within 12 months, 25°C ±5°C) ±(% of Output+Offset)	Voltage	≤0.02% + 0.02%FS
	Current	≤0.1% + 0.1%FS
	Power	≤0.5% + 0.5%FS
	Resistance	≤1% + 1%FS
Read Back Accuracy (within 12 months, 25°C ±5°C) ±(% of Output+Offset)	Voltage	≤0.02% + 0.02%FS
	Current	≤0.1% + 0.1%FS
	Power	≤0.5% + 0.5%FS
	Resistance	≤1% + 1%FS
Ripple	Voltage	≤600mVpp(MAX: ≤1500mVpp)
(20Hz -20MHz)	Current	≤0.1%FS RMS
Setup Temperature Coefficient	Voltage	≤50PPM/°C
±(% of Output/°C+Offset)	Current	≤200PPM/°C
Read Back Temperature Coefficient	Voltage	≤50PPM/°C
±(% of Output/°C+Offset)	Current	≤200PPM/°C
Rise Time(no load)	Voltage	≤15ms
Rise Time(full load)	Voltage	≤30ms
Fall Time(no load)	Voltage	≤30ms

Parameter		IT6108C-1500-240
Fall Time(full load)	Voltage	≤15ms
Transient Response Time	Voltage	≤2ms
AC Input	Voltage (Three-phase + PE) 1	198V ~ 264V (Power derating 50%) 342V ~ 528V
	Maximum Input Current	200.18A
	Maximum Input Apparent Power	118.6kVA
	Frequency	47Hz ~ 63Hz
Setup Stability-30min	Voltage	≤0.02% + 0.02%FS
±(%of Output+Offset)	Current	≤0.1% + 0.1%FS
Setup stability-8h	Voltage	≤0.02% + 0.02%FS
±(%of Output+Offset)	Current	≤0.1% + 0.1%FS
Readback Stability-30min	Voltage	≤0.02% + 0.02%FS
±(%of Output+Offset)	Current	≤0.1% + 0.1%FS
Readback stability-8h	Voltage	≤0.02% + 0.02%FS
±(%of Output+Offset)	Current	≤0.1% + 0.1%FS
Efficiency	~ 92%	
Remote Sense Compensation Voltage	≤15V	
Command Response Time	2mS	
Power Factor	0.99	
Storage Temperature	-10°C ~ 70°C	
Protective Function	OVP, OCP, OPP, UVP, UCP, OTP, Vsense protection	
Standard Interface	Standard: USB, CAN, LAN, VCP; optional: GPIB, analog card (includes RS232), fiber optic socket	
Isolation (output to ground)	1800V	
Working Temperature	0 ~ 50°C	
Dimension (mm)	600mm(W)*917.61mm(D)*1441.41mm(H)	
Weight(net)	366.5KG	

Note: 1. Models without emergency stop module (i.e. AC contactor not included), other AC input voltage ranges are required for customization. Models without emergency stop module and assembled to the cabinet, with AC input voltage in the range of 198~264V, need to be customized while derating by 50%. Models with emergency stop module (including AC contactor) only support 380VAC±10% for standard AC input voltage, 480VAC±10% voltage is required for customization.

6.1.5.7 IT6126C-1500-280

Parameter		IT6126C-1500-280
Rated value (0 °C-50 °C)	Output Voltage	0 ~ 1500V
	Output Current	-280 ~ 280A
	Output Power	-126 ~ 126kW
	Output Resistance	0 ~ 1Ω
Line Regulation	Voltage	≤0.01%FS
±(% of Output+Offset)	Current	≤0.05%FS
Load Regulation	Voltage	≤0.02%FS
±(% of Output+Offset)	Current	≤0.05%FS
Setup Resolution	Voltage	0.1V
	Current	0.01A
	Power	0.001kW
	Resistance	0.001Ω
Read Back Resolution	Voltage	0.1V
	Current	0.01A
	Power	0.001kW
	Resistance	0.001Ω
Setup Accuracy (within 12 months, 25°C ±5°C) ±(% of Output+Offset)	Voltage	≤0.02% + 0.02%FS
	Current	≤0.1% + 0.1%FS
	Power	≤0.5% + 0.5%FS
	Resistance	≤1% + 1%FS
Read Back Accuracy (with-in 12 months, 25°C ±5°C) ±(% of Output+Offset)	Voltage	≤0.02% + 0.02%FS
	Current	≤0.1% + 0.1%FS
	Power	≤0.5% + 0.5%FS
	Resistance	≤1% + 1%FS
Ripple	Voltage	≤600mVpp(MAX: ≤1500mVpp)
	(20Hz -20MHz)	Current
Setup Temperature Coefficient	Voltage	≤50PPM/°C
±(% of Output/°C+Offset)	Current	≤200PPM/°C
Read Back Temperature Coefficient	Voltage	≤50PPM/°C

Parameter		IT6126C-1500-280
±(% of Output/°C+Offset)	Current	≤200PPM/°C
Rise Time(no load)	Voltage	≤15ms
Rise Time(full load)	Voltage	≤30ms
Fall Time(no load)	Voltage	≤30ms
Fall Time(full load)	Voltage	≤15ms
Transient Response Time	Voltage	≤2ms
AC Input	Voltage (Three-phase + PE) 1	198V ~ 264V (Power derating 50%) 342V ~ 528V
	Maximum Input Current	233.54A
	Maximum Input Apparent Power	138.3kVA
	Frequency	47Hz ~ 63Hz
Setup Stability-30min	Voltage	≤0.02% + 0.02%FS
±(% of Output+Offset)	Current	≤0.1% + 0.1%FS
Setup stability-8h	Voltage	≤0.02% + 0.02%FS
±(% of Output+Offset)	Current	≤0.1% + 0.1%FS
Readback Stability-30min	Voltage	≤0.02% + 0.02%FS
±(% of Output+Offset)	Current	≤0.1% + 0.1%FS
Readback stability-8h	Voltage	≤0.02% + 0.02%FS
±(% of Output+Offset)	Current	≤0.1% + 0.1%FS
Efficiency		~ 92%
Remote Sense Compensation Voltage		≤15V
Command Response Time		2mS
Power Factor		0.99
Storage Temperature		-10°C ~ 70°C
Protective Function		OVP, OCP, OPP, UVP, UCP, OTP, Vsense protection
Standard Interface		Standard: USB, CAN, LAN, VCP; optional: GPIB, analog card (includes RS232), fiber optic socket
Isolation (output to ground)		1800V
Working Temperature		0 ~ 50°C
Dimension (mm)		600mm(W)*917.61mm(D)*1441.41mm(H)
Weight(net)		409.7KG

Parameter	IT6126C-1500-280
-----------	------------------

Note: 1. Models without emergency stop module (i.e. AC contactor not included), other AC input voltage ranges are required for customization. Models without emergency stop module and assembled to the cabinet, with AC input voltage in the range of 198~264V, need to be customized while derating by 50%. Models with emergency stop module (including AC contactor) only support 380VAC±10% for standard AC input voltage, 480VAC±10% voltage is required for customization.

6.1.5.8 IT6144C-1500-320

Parameter		IT6144C-1500-320
Rated value (0 °C-50 °C)	Output Voltage	0 ~ 1500V
	Output Current	-320 ~ 320A
	Output Power	-144 ~ 144kW
	Output Resistance	0 ~ 1Ω
Line Regulation	Voltage	≤0.01%FS
	Current	≤0.05%FS
±(%of Output+Offset)	Voltage	≤0.02%FS
	Current	≤0.05%FS
Setup Resolution	Voltage	0.1V
	Current	0.01A
	Power	0.001kW
	Resistance	0.001Ω
Read Back Resolution	Voltage	0.1V
	Current	0.01A
	Power	0.001kW
	Resistance	0.001Ω
Setup Accuracy (within 12 months, 25°C ±5°C) ±(% ofOutput+Offset)	Voltage	≤0.02% + 0.02%FS
	Current	≤0.1% + 0.1%FS
	Power	≤0.5% + 0.5%FS
	Resistance	≤1% + 1%FS
Read Back Accuracy (with-in 12 months, 25°C ±5°C) ±(%of Output+Offset)	Voltage	≤0.02% + 0.02%FS
	Current	≤0.1% + 0.1%FS
	Power	≤0.5% + 0.5%FS
	Resistance	≤1% + 1%FS
Ripple	Voltage	≤600mVpp(MAX: ≤1500mVpp)

Parameter		IT6144C-1500-320
(20Hz -20MHz)	Current	≤0.1%FS RMS
Setup Temperature Coefficient	Voltage	≤50PPM/°C
±(% of Output/°C+Offset)	Current	≤200PPM/°C
Read Back Temperature Coefficient	Voltage	≤50PPM/°C
±(% of Output/°C+Offset)	Current	≤200PPM/°C
Rise Time(no load)	Voltage	≤15ms
Rise Time(full load)	Voltage	≤30ms
Fall Time(no load)	Voltage	≤30ms
Fall Time(full load)	Voltage	≤15ms
Transient Response Time	Voltage	≤2ms
AC Input	Voltage (Three-phase + PE) 1	198V ~ 264V (Power derating 50%) 342V ~ 528V
	Maximum Input Current	266.9A
	Maximum Input Apparent Power	158.1kVA
	Frequency	47Hz ~ 63Hz
Setup Stability-30min	Voltage	≤0.02% + 0.02%FS
±(% of Output+Offset)	Current	≤0.1% + 0.1%FS
Setup stability-8h	Voltage	≤0.02% + 0.02%FS
±(% of Output+Offset)	Current	≤0.1% + 0.1%FS
Readback Stability-30min	Voltage	≤0.02% + 0.02%FS
±(% of Output+Offset)	Current	≤0.1% + 0.1%FS
Readback stability-8h	Voltage	≤0.02% + 0.02%FS
±(% of Output+Offset)	Current	≤0.1% + 0.1%FS
Efficiency		~ 92%
Remote Sense Compensation Voltage		≤15V
Command Response Time		2mS
Power Factor		0.99
Storage Temperature		-10°C ~ 70°C
Protective Function	OVP, OCP, OPP, UVP, UCP, OTP, Vsense protection	

Parameter	IT6144C-1500-320
Standard Interface	Standard: USB, CAN, LAN, VCP; optional: GPIB, analog card (includes RS232), fiber optic socket
Isolation (output to ground)	1800V
Working Temperature	0 ~ 50°C
Dimension (mm)	600mm(W)*917.61mm(D)*1441.41mm(H)
Weight(net)	452.8KG

Note: 1. Models without emergency stop module (i.e. AC contactor not included), other AC input voltage ranges are required for customization. Models without emergency stop module and assembled to the cabinet, with AC input voltage in the range of 198~264V, need to be customized while derating by 50%. Models with emergency stop module (including AC contactor) only support 380VAC±10% for standard AC input voltage, 480VAC±10% voltage is required for customization.

6.1.6 2250V

6.1.6.1 IT6018C-2250-25

Parameter		IT6018C-2250-25
Rated value (0 °C-50 °C)	Output Voltage	0 ~ 2250V
	Output Current	-25 ~ 25A
	Output Power	-18 ~ 18kW
	Output Resistance	0 ~ 1Ω
Line Regulation	Voltage	≤0.01%FS
±(%of Output+Offset)	Current	≤0.05%FS
Load Regulation	Voltage	≤0.02%FS
±(%of Output+Offset)	Current	≤0.05%FS
Setup Resolution	Voltage	0.1V
	Current	0.001A
	Power	0.001kW
	Resistance	0.001Ω
Read Back Resolution	Voltage	0.1V
	Current	0.001A
	Power	0.001kW
	Resistance	0.001Ω

Parameter		IT6018C-2250-25
Setup Accuracy (within 12 months, 25°C ±5°C) ±(% of Output+Offset)	Voltage	≤0.02% + 0.02%FS
	Current	≤0.1% + 0.1%FS
	Power	≤0.5% + 0.5%FS
	Resistance	≤1% + 1%FS
Read Back Accuracy (within 12 months, 25°C ±5°C) ±(% of Output+Offset)	Voltage	≤0.02% + 0.02%FS
	Current	≤0.1% + 0.1%FS
	Power	≤0.5% + 0.5%FS
	Resistance	≤1% + 1%FS
Ripple (20Hz -20MHz)	Voltage	≤900mVpp(MAX:≤2250mVpp)
	Current	≤0.1%FS RMS
Setup Temperature Coefficient ±(% of Output/°C+Offset)	Voltage	≤50PPM/°C
	Current	≤200PPM/°C
Read Back Temperature Coefficient ±(% of Output/°C+Offset)	Voltage	≤50PPM/°C
	Current	≤200PPM/°C
Rise Time(no load)	Voltage	≤15ms
Rise Time(full load)	Voltage	≤30ms
Fall Time(no load)	Voltage	≤30ms
Fall Time(full load)	Voltage	≤15ms
Transient Response Time	Voltage	≤2ms
AC Input	Voltage (Three-phase + PE) 1	198V ~ 264V (Power derating 50%) 342V ~ 528V
	Maximum Input Current	33.37A
	Maximum Input Apparent Power	19.8kVA
	Frequency	47Hz ~ 63Hz
Setup Stability-30min ±(% of Output+Offset)	Voltage	≤0.02% + 0.02%FS
	Current	≤0.1% + 0.1%FS
Setup stability-8h ±(% of Output+Offset)	Voltage	≤0.02% + 0.02%FS
	Current	≤0.1% + 0.1%FS
Readback Stability-30min ±(% of Output+Offset)	Voltage	≤0.02% + 0.02%FS
	Current	≤0.1% + 0.1%FS

Parameter		IT6018C-2250-25
Readback stability-8h	Voltage	$\leq 0.02\% + 0.02\%FS$
\pm (%of Output+Offset)	Current	$\leq 0.1\% + 0.1\%FS$
Efficiency		~ 92%
Remote Sense Compensation Voltage		$\leq 22.5V$
Command Response Time		2mS
Power Factor		0.99
Storage Temperature		-10°C ~ 70°C
Protective Function		OVP, OCP, OPP, UVP, UCP, OTP, Vsense protection
Standard Interface		Standard: USB, CAN, LAN, VCP; optional: GPIB, analog card (includes RS232), fiber optic socket
Isolation (output to ground)		3000V
Working Temperature		0 ~ 50°C
Dimension (mm)		483mm(W)*801.61mm(D)*151.3mm(H)
Weight(net)		40KG

Note: 1. Models without emergency stop module (i.e. AC contactor not included), other AC input voltage ranges are required for customization. Models without emergency stop module and assembled to the cabinet, with AC input voltage in the range of 198~264V, need to be customized while derating by 50%. Models with emergency stop module (including AC contactor) only support 380VAC \pm 10% for standard AC input voltage, 480VAC \pm 10% voltage is required for customization.

6.1.6.2 IT6036C-2250-50

Parameter		IT6036C-2250-50
Rated value (0 °C-50 °C)	Output Voltage	0 ~ 2250V
	Output Current	-50 ~ 50A
	Output Power	-36 ~ 36kW
	Output Resistance	0 ~ 1 Ω
Line Regulation	Voltage	$\leq 0.01\%FS$
\pm (%of Output+Offset)	Current	$\leq 0.05\%FS$
Load Regulation	Voltage	$\leq 0.02\%FS$
\pm (%of Output+Offset)	Current	$\leq 0.05\%FS$
Setup Resolution	Voltage	0.1V
	Current	0.01A

Parameter		IT6036C-2250-50
	Power	0.001kW
	Resistance	0.001Ω
Read Back Resolution	Voltage	0.1V
	Current	0.01A
	Power	0.001kW
	Resistance	0.001Ω
Setup Accuracy (within 12 months, 25°C ±5°C) ±(% of Output+Offset)	Voltage	≤0.02% + 0.02%FS
	Current	≤0.1% + 0.1%FS
	Power	≤0.5% + 0.5%FS
	Resistance	≤1% + 1%FS
Read Back Accuracy (within 12 months, 25°C ±5°C) ±(% of Output+Offset)	Voltage	≤0.02% + 0.02%FS
	Current	≤0.1% + 0.1%FS
	Power	≤0.5% + 0.5%FS
	Resistance	≤1% + 1%FS
Ripple	Voltage	≤900mVpp(MAX:≤2250mVpp)
(20Hz -20MHz)	Current	≤0.1%FS RMS
Setup Temperature Coefficient	Voltage	≤50PPM/°C
±(% of Output/°C+Offset)	Current	≤200PPM/°C
Read Back Temperature Coefficient	Voltage	≤50PPM/°C
±(% of Output/°C+Offset)	Current	≤200PPM/°C
Rise Time(no load)	Voltage	≤15ms
Rise Time(full load)	Voltage	≤30ms
Fall Time(no load)	Voltage	≤30ms
Fall Time(full load)	Voltage	≤15ms
Transient Response Time	Voltage	≤2ms
AC Input	Voltage (Three-phase + PE) 1	198V ~ 264V (Power derating 50%) 342V ~ 528V
	Maximum Input Current	66.73A
	Maximum Input Apparent Power	39.5kVA
	Frequency	47Hz ~ 63Hz
Setup Stability-30min	Voltage	≤0.02% + 0.02%FS

Parameter		IT6036C-2250-50
±(% of Output+Offset)	Current	≤0.1% +0.1%FS
Setup stability-8h	Voltage	≤0.02% + 0.02%FS
±(% of Output+Offset)	Current	≤0.1% +0.1%FS
Readback Stability-30min	Voltage	≤0.02% + 0.02%FS
±(% of Output+Offset)	Current	≤0.1% +0.1%FS
Readback stability-8h	Voltage	≤0.02% + 0.02%FS
±(% of Output+Offset)	Current	≤0.1% +0.1%FS
Efficiency		~ 92%
Remote Sense Compensation Voltage		≤22.5V
Command Response Time		2mS
Power Factor		0.99
Storage Temperature		-10°C ~ 70°C
Protective Function		OVP, OCP, OPP, UVP, UCP, OTP, Vsense protection
Standard Interface		Standard: USB, CAN, LAN, VCP; optional: GPIB, analog card (includes RS232), fiber optic socket
Isolation (output to ground)		3000V
Working Temperature		0 ~ 50°C
Dimension (mm)		483mm(W)*801.61mm(D)*348.84mm(H)
Weight(net)		95KG

Note: 1. Models without emergency stop module (i.e. AC contactor not included), other AC input voltage ranges are required for customization. Models without emergency stop module and assembled to the cabinet, with AC input voltage in the range of 198~264V, need to be customized while derating by 50%. Models with emergency stop module (including AC contactor) only support 380VAC±10% for standard AC input voltage, 480VAC±10% voltage is required for customization.

6.1.6.3 IT6054B-2250-75

Parameter		IT6054B-2250-75
Rated value (0 °C-50 °C)	Output Voltage	0 ~ 2250V
	Output Current	-75 ~ 75A
	Output Power	-54 ~ 54kW
	Output Resistance	0 ~ 1Ω
Line Regulation	Voltage	≤0.01%FS

Parameter		IT6054B-2250-75
±(% of Output+Offset)	Current	≤0.05%FS
Load Regulation	Voltage	≤0.02%FS
±(% of Output+Offset)	Current	≤0.05%FS
Setup Resolution	Voltage	0.1V
	Current	0.01A
	Power	0.001kW
	Resistance	0.001Ω
Read Back Resolution	Voltage	0.1V
	Current	0.01A
	Power	0.001kW
	Resistance	0.001Ω
Setup Accuracy (within 12 months, 25°C ±5°C) ±(% of Output+Offset)	Voltage	≤0.02% + 0.02%FS
	Current	≤0.1% + 0.1%FS
	Power	≤0.5% + 0.5%FS
	Resistance	≤1% + 1%FS
Read Back Accuracy (within 12 months, 25°C ±5°C) ±(% of Output+Offset)	Voltage	≤0.02% + 0.02%FS
	Current	≤0.1% + 0.1%FS
	Power	≤0.5% + 0.5%FS
	Resistance	≤1% + 1%FS
Ripple (20Hz -20MHz)	Voltage	≤900mVpp(MAX:≤2250mVpp)
	Current	≤0.1%FS RMS
Setup Temperature Coefficient	Voltage	≤50PPM/°C
±(% of Output/°C+Offset)	Current	≤200PPM/°C
Read Back Temperature Coefficient	Voltage	≤50PPM/°C
±(% of Output/°C+Offset)	Current	≤200PPM/°C
Rise Time(no load)	Voltage	≤15ms
Rise Time(full load)	Voltage	≤30ms
Fall Time(no load)	Voltage	≤30ms
Fall Time(full load)	Voltage	≤15ms
Transient Response Time	Voltage	≤2ms

Parameter		IT6054B-2250-75
AC Input	Voltage (Three-phase + PE) 1	198V ~ 264V (Power derating 50%) 342V ~ 528V
	Maximum Input Current	100.09A
	Maximum Input Apparent Power	59.3kVA
	Frequency	47Hz ~ 63Hz
Setup Stability-30min	Voltage	$\leq 0.02\% + 0.02\%FS$
\pm (%of Output+Offset)	Current	$\leq 0.1\% + 0.1\%FS$
Setup stability-8h	Voltage	$\leq 0.02\% + 0.02\%FS$
\pm (%of Output+Offset)	Current	$\leq 0.1\% + 0.1\%FS$
Readback Stability-30min	Voltage	$\leq 0.02\% + 0.02\%FS$
\pm (%of Output+Offset)	Current	$\leq 0.1\% + 0.1\%FS$
Readback stability-8h	Voltage	$\leq 0.02\% + 0.02\%FS$
\pm (%of Output+Offset)	Current	$\leq 0.1\% + 0.1\%FS$
Efficiency	~ 92%	
Remote Sense Compensation Voltage	$\leq 22.5V$	
Command Response Time	2mS	
Power Factor	0.99	
Storage Temperature	$-10^{\circ}C \sim 70^{\circ}C$	
Protective Function	OVP, OCP, OPP, UVP, UCP, OTP, Vsense protection	
Standard Interface	Standard: USB, CAN, LAN, VCP; optional: GPIB, analog card (includes RS232), fiber optic socket	
Isolation (output to ground)	3000V	
Working Temperature	$0 \sim 50^{\circ}C$	
Dimension (mm)	550mm(W)*910.16mm(D)*907.64mm(H)	
Weight(net)	186KG	

Note:

1. The instrument needs to be customized under other AC input voltage ranges. For models equipped with an emergency stop module (including AC contactor), the AC input voltage range can only be: 342V ~ 528V

6.1.6.4 IT6072C-2250-100

Parameter		IT6072C-2250-100
Rated value (0 °C-50 °C)	Output Voltage	0 ~ 2250V
	Output Current	-100 ~ 100A
	Output Power	-72 ~ 72kW
	Output Resistance	0 ~ 1Ω
Line Regulation	Voltage	≤0.01%FS
±(%of Output+Offset)	Current	≤0.05%FS
Load Regulation	Voltage	≤0.02%FS
±(%of Output+Offset)	Current	≤0.05%FS
Setup Resolution	Voltage	0.1V
	Current	0.01A
	Power	0.001kW
	Resistance	0.001Ω
Read Back Resolution	Voltage	0.1V
	Current	0.01A
	Power	0.001kW
	Resistance	0.001Ω
Setup Accuracy (within 12 months, 25°C ±5°C) ±(% ofOutput+Offset)	Voltage	≤0.02% + 0.02%FS
	Current	≤0.1% + 0.1%FS
	Power	≤0.5% + 0.5%FS
	Resistance	≤1% + 1%FS
Read Back Accuracy (with-in 12 months, 25°C ±5°C) ±(%of Output+Offset)	Voltage	≤0.02% + 0.02%FS
	Current	≤0.1% + 0.1%FS
	Power	≤0.5% + 0.5%FS
	Resistance	≤1% + 1%FS
Ripple	Voltage	≤900mVpp(MAX:≤2250mVpp)
(20Hz -20MHz)	Current	≤0.1%FS RMS
Setup Temperature Coefficient	Voltage	≤50PPM/°C
±(%of Output/°C+Offset)	Current	≤200PPM/°C
Read Back Temperature Coefficient	Voltage	≤50PPM/°C
±(%of Output/°C+Offset)	Current	≤200PPM/°C

Parameter		IT6072C-2250-100
Rise Time(no load)	Voltage	≤15ms
Rise Time(full load)	Voltage	≤30ms
Fall Time(no load)	Voltage	≤30ms
Fall Time(full load)	Voltage	≤15ms
Transient Response Time	Voltage	≤2ms
AC Input	Voltage (Three-phase + PE) 1	198V ~ 264V (Power derating 50%) 342V ~ 528V
	Maximum Input Current	133.45A
	Maximum Input Apparent Power	79.1kVA
	Frequency	47Hz ~ 63Hz
Setup Stability-30min	Voltage	≤0.02% + 0.02%FS
±(% of Output+Offset)	Current	≤0.1% + 0.1%FS
Setup stability-8h	Voltage	≤0.02% + 0.02%FS
±(% of Output+Offset)	Current	≤0.1% + 0.1%FS
Readback Stability-30min	Voltage	≤0.02% + 0.02%FS
±(% of Output+Offset)	Current	≤0.1% + 0.1%FS
Readback stability-8h	Voltage	≤0.02% + 0.02%FS
±(% of Output+Offset)	Current	≤0.1% + 0.1%FS
Efficiency		~ 92%
Remote Sense Compensation Voltage		≤22.5V
Command Response Time		2mS
Power Factor		0.99
Storage Temperature		-10°C ~ 70°C
Protective Function	OVP, OCP, OPP, UVP, UCP, OTP, Vsense protection	
Standard Interface	Standard: USB, CAN, LAN, VCP; optional: GPIB, analog card (includes RS232), fiber optic socket	
Isolation (output to ground)		3000V
Working Temperature		0 ~ 50°C
Dimension (mm)	550mm(W)*910.16mm(D)*907.64mm(H)	
Weight(net)		228.9KG

Parameter	IT6072C-2250-100
-----------	------------------

Note: 1. Models without emergency stop module (i.e. AC contactor not included), other AC input voltage ranges are required for customization. Models without emergency stop module and assembled to the cabinet, with AC input voltage in the range of 198~264V, need to be customized while derating by 50%. Models with emergency stop module (including AC contactor) only support 380VAC±10% for standard AC input voltage, 480VAC±10% voltage is required for customization.

6.1.6.5 IT6090C-2250-125

Parameter		IT6090C-2250-125
Rated value (0 °C-50 °C)	Output Voltage	0 ~ 2250V
	Output Current	-125 ~ 125A
	Output Power	-90 ~ 90kW
	Output Resistance	0 ~ 1Ω
Line Regulation	Voltage	≤0.01%FS
±(% of Output+Offset)	Current	≤0.05%FS
Load Regulation	Voltage	≤0.02%FS
±(% of Output+Offset)	Current	≤0.05%FS
Setup Resolution	Voltage	0.1V
	Current	0.01A
	Power	0.001kW
	Resistance	0.001Ω
Read Back Resolution	Voltage	0.1V
	Current	0.01A
	Power	0.001kW
	Resistance	0.001Ω
Setup Accuracy (within 12 months, 25°C ±5°C) ±(% of Output+Offset)	Voltage	≤0.02% + 0.02%FS
	Current	≤0.1% + 0.1%FS
	Power	≤0.5% + 0.5%FS
	Resistance	≤1% + 1%FS
Read Back Accuracy (with-in 12 months, 25°C ±5°C) ±(% of Output+Offset)	Voltage	≤0.02% + 0.02%FS
	Current	≤0.1% + 0.1%FS
	Power	≤0.5% + 0.5%FS
	Resistance	≤1% + 1%FS
Ripple	Voltage	≤900mVpp(MAX:≤2250mVpp)

Parameter		IT6090C-2250-125
(20Hz -20MHz)	Current	≤0.1%FS RMS
Setup Temperature Coefficient	Voltage	≤50PPM/°C
±(% of Output/°C+Offset)	Current	≤200PPM/°C
Read Back Temperature Coefficient	Voltage	≤50PPM/°C
±(% of Output/°C+Offset)	Current	≤200PPM/°C
Rise Time(no load)	Voltage	≤15ms
Rise Time(full load)	Voltage	≤30ms
Fall Time(no load)	Voltage	≤30ms
Fall Time(full load)	Voltage	≤15ms
Transient Response Time	Voltage	≤2ms
AC Input	Voltage (Three-phase + PE) 1	198V ~ 264V (Power derating 50%) 342V ~ 528V
	Maximum Input Current	166.81A
	Maximum Input Apparent Power	98.8kVA
	Frequency	47Hz ~ 63Hz
Setup Stability-30min	Voltage	≤0.02% + 0.02%FS
±(% of Output+Offset)	Current	≤0.1% +0.1%FS
Setup stability-8h	Voltage	≤0.02% + 0.02%FS
±(% of Output+Offset)	Current	≤0.1% +0.1%FS
Readback Stability-30min	Voltage	≤0.02% + 0.02%FS
±(% of Output+Offset)	Current	≤0.1% +0.1%FS
Readback stability-8h	Voltage	≤0.02% + 0.02%FS
±(% of Output+Offset)	Current	≤0.1% +0.1%FS
Efficiency		~ 92%
Remote Sense Compensation Voltage		≤22.5V
Command Response Time		2mS
Power Factor		0.99
Storage Temperature		-10°C ~ 70°C
Protective Function	OVP, OCP, OPP, UVP, UCP, OTP, Vsense protection	

Parameter	IT6090C-2250-125
Standard Interface	Standard: USB, CAN, LAN, VCP; optional: GPIB, analog card (includes RS232), fiber optic socket
Isolation (output to ground)	3000V
Working Temperature	0 ~ 50°C
Dimension (mm)	600mm(W)*917.61mm(D)*1441.41mm(H)
Weight(net)	323.5KG

Note: 1. Models without emergency stop module (i.e. AC contactor not included), other AC input voltage ranges are required for customization. Models without emergency stop module and assembled to the cabinet, with AC input voltage in the range of 198~264V, need to be customized while derating by 50%. Models with emergency stop module (including AC contactor) only support 380VAC±10% for standard AC input voltage, 480VAC±10% voltage is required for customization.

6.1.6.6 IT6108C-2250-150

Parameter		IT6108C-2250-150
Rated value (0 °C-50 °C)	Output Voltage	0 ~ 2250V
	Output Current	-150 ~ 150A
	Output Power	-108 ~ 108kW
	Output Resistance	0 ~ 1Ω
Line Regulation	Voltage	≤0.01%FS
±(%of Output+Offset)	Current	≤0.05%FS
Load Regulation	Voltage	≤0.02%FS
±(%of Output+Offset)	Current	≤0.05%FS
Setup Resolution	Voltage	0.1V
	Current	0.01A
	Power	0.001kW
	Resistance	0.001Ω
Read Back Resolution	Voltage	0.1V
	Current	0.01A
	Power	0.001kW
	Resistance	0.001Ω
Setup Accuracy (within 12 months, 25°C ±5°C) ±(% ofOutput+Offset)	Voltage	≤0.02% + 0.02%FS
	Current	≤0.1% + 0.1%FS
	Power	≤0.5% + 0.5%FS

Parameter		IT6108C-2250-150
	Resistance	$\leq 1\% + 1\%FS$
Read Back Accuracy (with-in 12 months, 25°C ±5°C) ±(% of Output+Offset)	Voltage	$\leq 0.02\% + 0.02\%FS$
	Current	$\leq 0.1\% + 0.1\%FS$
	Power	$\leq 0.5\% + 0.5\%FS$
	Resistance	$\leq 1\% + 1\%FS$
Ripple	Voltage	$\leq 900mVpp(MAX:\leq 2250mVpp)$
(20Hz -20MHz)	Current	$\leq 0.1\%FS RMS$
Setup Temperature Coefficient	Voltage	$\leq 50PPM/^{\circ}C$
±(% of Output/ $^{\circ}C$ +Offset)	Current	$\leq 200PPM/^{\circ}C$
Read Back Temperature Coefficient	Voltage	$\leq 50PPM/^{\circ}C$
±(% of Output/ $^{\circ}C$ +Offset)	Current	$\leq 200PPM/^{\circ}C$
Rise Time(no load)	Voltage	$\leq 15ms$
Rise Time(full load)	Voltage	$\leq 30ms$
Fall Time(no load)	Voltage	$\leq 30ms$
Fall Time(full load)	Voltage	$\leq 15ms$
Transient Response Time	Voltage	$\leq 2ms$
AC Input	Voltage (Three-phase + PE) 1	198V ~ 264V (Power derating 50%) 342V ~ 528V
	Maximum Input Current	200.18A
	Maximum Input Apparent Power	118.6kVA
	Frequency	47Hz ~ 63Hz
Setup Stability-30min	Voltage	$\leq 0.02\% + 0.02\%FS$
±(% of Output+Offset)	Current	$\leq 0.1\% + 0.1\%FS$
Setup stability-8h	Voltage	$\leq 0.02\% + 0.02\%FS$
±(% of Output+Offset)	Current	$\leq 0.1\% + 0.1\%FS$
Readback Stability-30min	Voltage	$\leq 0.02\% + 0.02\%FS$
±(% of Output+Offset)	Current	$\leq 0.1\% + 0.1\%FS$
Readback stability-8h	Voltage	$\leq 0.02\% + 0.02\%FS$
±(% of Output+Offset)	Current	$\leq 0.1\% + 0.1\%FS$
Efficiency		~ 92%

Parameter		IT6108C-2250-150
Remote Sense Compensation Voltage		≤22.5V
Command Response Time		2mS
Power Factor		0.99
Storage Temperature		-10°C ~ 70°C
Protective Function		OVP, OCP, OPP, UVP, UCP, OTP, Vsense protection
Standard Interface		Standard: USB, CAN, LAN, VCP; optional: GPIB, analog card (includes RS232), fiber optic socket
Isolation (output to ground)		3000V
Working Temperature		0 ~ 50°C
Dimension (mm)		600mm(W)*917.61mm(D)*1441.41mm(H)
Weight(net)		366.5KG

Note: 1. Models without emergency stop module (i.e. AC contactor not included), other AC input voltage ranges are required for customization. Models without emergency stop module and assembled to the cabinet, with AC input voltage in the range of 198~264V, need to be customized while derating by 50%. Models with emergency stop module (including AC contactor) only support 380VAC±10% for standard AC input voltage, 480VAC±10% voltage is required for customization.

6.1.6.7 IT6126C-2250-175

Parameter		IT6126C-2250-175
Rated value (0 °C-50 °C)	Output Voltage	0 ~ 2250V
	Output Current	-175 ~ 175A
	Output Power	-126 ~ 126kW
	Output Resistance	0 ~ 1Ω
Line Regulation	Voltage	≤0.01%FS
±(%of Output+Offset)	Current	≤0.05%FS
Load Regulation	Voltage	≤0.02%FS
±(%of Output+Offset)	Current	≤0.05%FS
Setup Resolution	Voltage	0.1V
	Current	0.01A
	Power	0.001kW
	Resistance	0.001Ω
Read Back Resolution	Voltage	0.1V

Parameter		IT6126C-2250-175
	Current	0.01A
	Power	0.001kW
	Resistance	0.001Ω
Setup Accuracy (within 12 months, 25°C ±5°C) ±(% of Output+Offset)	Voltage	≤0.02% + 0.02%FS
	Current	≤0.1% + 0.1%FS
	Power	≤0.5% + 0.5%FS
	Resistance	≤1% + 1%FS
Read Back Accuracy (within 12 months, 25°C ±5°C) ±(% of Output+Offset)	Voltage	≤0.02% + 0.02%FS
	Current	≤0.1% + 0.1%FS
	Power	≤0.5% + 0.5%FS
	Resistance	≤1% + 1%FS
Ripple (20Hz -20MHz)	Voltage	≤900mVpp(MAX:≤2250mVpp)
	Current	≤0.1%FS RMS
Setup Temperature Coefficient	Voltage	≤50PPM/°C
±(% of Output/°C+Offset)	Current	≤200PPM/°C
Read Back Temperature Coefficient	Voltage	≤50PPM/°C
±(% of Output/°C+Offset)	Current	≤200PPM/°C
Rise Time(no load)	Voltage	≤15ms
Rise Time(full load)	Voltage	≤30ms
Fall Time(no load)	Voltage	≤30ms
Fall Time(full load)	Voltage	≤15ms
Transient Response Time	Voltage	≤2ms
AC Input	Voltage (Three-phase + PE) 1	198V ~ 264V (Power derating 50%) 342V ~ 528V
	Maximum Input Current	233.54A
	Maximum Input Apparent Power	138.3kVA
	Frequency	47Hz ~ 63Hz
Setup Stability-30min	Voltage	≤0.02% + 0.02%FS
±(% of Output+Offset)	Current	≤0.1% +0.1%FS
Setup stability-8h	Voltage	≤0.02% + 0.02%FS
±(% of Output+Offset)	Current	≤0.1% +0.1%FS

Parameter		IT6126C-2250-175
Readback Stability-30min	Voltage	$\leq 0.02\% + 0.02\%FS$
\pm (%of Output+Offset)	Current	$\leq 0.1\% + 0.1\%FS$
Readback stability-8h	Voltage	$\leq 0.02\% + 0.02\%FS$
\pm (%of Output+Offset)	Current	$\leq 0.1\% + 0.1\%FS$
Efficiency		$\sim 92\%$
Remote Sense Compensation Voltage		$\leq 22.5V$
Command Response Time		2mS
Power Factor		0.99
Storage Temperature		$-10^{\circ}C \sim 70^{\circ}C$
Protective Function		OVP, OCP, OPP, UVP, UCP, OTP, Vsense protection
Standard Interface		Standard: USB, CAN, LAN, VCP; optional: GPIB, analog card (includes RS232), fiber optic socket
Isolation (output to ground)		3000V
Working Temperature		$0 \sim 50^{\circ}C$
Dimension (mm)		600mm(W)*917.61mm(D)*1441.41mm(H)
Weight(net)		409.7KG

Note: 1. Models without emergency stop module (i.e. AC contactor not included), other AC input voltage ranges are required for customization. Models without emergency stop module and assembled to the cabinet, with AC input voltage in the range of 198~264V, need to be customized while derating by 50%. Models with emergency stop module (including AC contactor) only support 380VAC $\pm 10\%$ for standard AC input voltage, 480VAC $\pm 10\%$ voltage is required for customization.

6.1.6.8 IT6144C-2250-200

Parameter		IT6144C-2250-200
Rated value (0 °C-50 °C)	Output Voltage	0 ~ 2250V
	Output Current	-200 ~ 200A
	Output Power	-144 ~ 144kW
	Output Resistance	0 ~ 1 Ω
Line Regulation	Voltage	$\leq 0.01\%FS$
\pm (%of Output+Offset)	Current	$\leq 0.05\%FS$
Load Regulation	Voltage	$\leq 0.02\%FS$
\pm (%of Output+Offset)	Current	$\leq 0.05\%FS$

Parameter		IT6144C-2250-200
Setup Resolution	Voltage	0.1V
	Current	0.01A
	Power	0.001kW
	Resistance	0.001Ω
Read Back Resolution	Voltage	0.1V
	Current	0.01A
	Power	0.001kW
	Resistance	0.001Ω
Setup Accuracy (within 12 months, 25°C ±5°C) ±(% of Output+Offset)	Voltage	≤0.02% + 0.02%FS
	Current	≤0.1% + 0.1%FS
	Power	≤0.5% + 0.5%FS
	Resistance	≤1% + 1%FS
Read Back Accuracy (within 12 months, 25°C ±5°C) ±(% of Output+Offset)	Voltage	≤0.02% + 0.02%FS
	Current	≤0.1% + 0.1%FS
	Power	≤0.5% + 0.5%FS
	Resistance	≤1% + 1%FS
Ripple (20Hz -20MHz)	Voltage	≤900mVpp(MAX:≤2250mVpp)
	Current	≤0.1%FS RMS
Setup Temperature Coefficient ±(% of Output/°C+Offset)	Voltage	≤50PPM/°C
	Current	≤200PPM/°C
Read Back Temperature Coefficient ±(% of Output/°C+Offset)	Voltage	≤50PPM/°C
	Current	≤200PPM/°C
Rise Time(no load)	Voltage	≤15ms
Rise Time(full load)	Voltage	≤30ms
Fall Time(no load)	Voltage	≤30ms
Fall Time(full load)	Voltage	≤15ms
Transient Response Time	Voltage	≤2ms
AC Input	Voltage (Three-phase + PE) 1	198V ~ 264V (Power derating 50%) 342V ~ 528V
	Maximum Input Current	266.9A
	Maximum Input Apparent Power	158.1kVA

Parameter		IT6144C-2250-200
	Frequency	47Hz ~ 63Hz
Setup Stability-30min	Voltage	$\leq 0.02\% + 0.02\%FS$
$\pm(\% \text{ of Output} + \text{Offset})$	Current	$\leq 0.1\% + 0.1\%FS$
Setup stability-8h	Voltage	$\leq 0.02\% + 0.02\%FS$
$\pm(\% \text{ of Output} + \text{Offset})$	Current	$\leq 0.1\% + 0.1\%FS$
Readback Stability-30min	Voltage	$\leq 0.02\% + 0.02\%FS$
$\pm(\% \text{ of Output} + \text{Offset})$	Current	$\leq 0.1\% + 0.1\%FS$
Readback stability-8h	Voltage	$\leq 0.02\% + 0.02\%FS$
$\pm(\% \text{ of Output} + \text{Offset})$	Current	$\leq 0.1\% + 0.1\%FS$
Efficiency		~ 92%
Remote Sense Compensation Voltage		$\leq 22.5V$
Command Response Time		2mS
Power Factor		0.99
Storage Temperature		-10°C ~ 70°C
Protective Function		OVP, OCP, OPP, UVP, UCP, OTP, Vsense protection
Standard Interface		Standard: USB, CAN, LAN, VCP; optional: GPIB, analog card (includes RS232), fiber optic socket
Isolation (output to ground)		3000V
Working Temperature		0 ~ 50°C
Dimension (mm)		600mm(W)*917.61mm(D)*1441.41mm(H)
Weight(net)		452.8KG

Note: 1. Models without emergency stop module (i.e. AC contactor not included), other AC input voltage ranges are required for customization. Models without emergency stop module and assembled to the cabinet, with AC input voltage in the range of 198~264V, need to be customized while derating by 50%. Models with emergency stop module (including AC contactor) only support 380VAC \pm 10% for standard AC input voltage, 480VAC \pm 10% voltage is required for customization.

6.7 Supplemental Characteristics

State storage capacity: 10 sets

Recommended calibration frequency: once a year

Cooling style: fans

7 Routine Maintenance

This chapter describes the general maintenance items and maintenance methods of the device.

- ◆ Instrument Self-Test
- ◆ Cleaning and Maintenance
- ◆ Contact of ITECH Engineers
- ◆ Return for Repair

7.1 Instrument Self-Test

Self-test checks that the minimum set of logic and power mesh systems are functioning properly. Self-test does not enable the output or place any voltages on the output. Self-test can be achieved in two ways:

- Re-start the instrument. Each time the instrument is powered on, the self-test is performed. This test assumes that the instrument is running.
- SCPI command: *TST?. If the return value is 0, the self-test passes; if it is 1, the self-test fails. If the self-test fails, please send command **SYSTem:ER-Ror?** to view the self-test error. Please refer to *Programming Guide* for the list of error codes.



Ensure that all test cables connections are removed when self-test is performed. During self-test, errors may be induced by signals present on external wiring, such as long test leads that can act as antennae.

7.2 Cleaning and Maintenance

To ensure the safety function and performance of the instrument, please clean and maintain the instrument properly.

WARNING

- **To prevent electrical shock, disconnect the instrument from AC mains power and disconnect all test leads before cleaning.**
 - **Do not use detergent or solvents.**
 - **Do not disassemble the instrument and attempt to clean internally.**
-

Clean the outside and the front panel screen of the instrument using a soft, lint-free, cloth slightly dampened with water. Use a brush to clean the dust on the vent and cooling fans.

7.3 Contact of ITECH Engineers

This section describes operations to be carried out by the user in case of failure of the instrument.

Preparation before contact

When the instrument fails, you should make the following preparations before returning the instrument to ITECH for repair or contacting engineers.

- Check all the items listed in the [Self-inspection of equipment faults](#) and confirm whether there are still some problems.
- Collect the SN of the instrument.
For details, see [Collect the SN number](#).

If there are still some problems, carefully read the **Warranty** and **Limitation of Warranty** in the preface of the manual. Confirm that your instrument complies with warranty service conditions. If after your warranty expires, ITECH offers repair services at competitive prices.

Self-inspection of equipment faults

When the instrument fails, make the following checks to ensure that the failure is in the instrument rather than any external connections. If the instrument failure can be eliminated via simple inspection, the maintenance cost and time can be saved.

- Check whether the AC power cord is securely connected to the instrument and to a AC distribution panel.
- Check whether the front-panel Power On switch has been turned on.
- Check whether self-inspection of the instrument is successful and whether the specifications and performance are within the indicator ranges.

- Check whether the instrument displays error information.
- Use other instruments instead of this instrument for confirmation.

Collect the SN number

ITECH will constantly improve the product performance, availability and reliability. The service personnel of ITECH will record changes of each instrument. All relevant information is marked uniquely according to the serial number of each instrument. The equipment returned for repair must adopt the SN number as the tracking ID.

When you contact the engineer, the effective SN number of the instrument will be the effective guarantee for effective service and complete information. You can obtain the SN number of the instrument by the following ways:

- Enter the System menu to obtain the SN.
 1. Press the composite keys **[Shift]+[P-set]** (System) on the front panel to enter the system menu.
 2. Use Up / Down key or rotate the knob to select **System Info** and press **[Enter]** key.
 3. Use Up / Down key or rotate the knob to view the SN number.

Please record the SN number and provide SN information when doing maintenance service.

- View the barcode on the back panel of the instrument.

How to contact ITECH engineers

Access ITECH official website www.itechate.com or call the service number 4006-025-000 for technical support and services.

7.4 Return for Repair

If your instrument fails during the warranty period, ITECH will repair or replace it under the terms of your warranty. After your warranty expires, ITECH offers repair services at competitive prices. Also you can purchase an extended maintenance service contract that exceeds the standard warranty period.

Get Repair Service

To get the service for your instrument, choose the easiest way to contact the ITECH engineers. ITECH will arrange for repair or replacement of your instrument or provide warranty and repair cost information (if applicable).

Repackaging for Shipment

CAUTION

Never use styrene pellets in any shape as packaging materials. They do not adequately cushion the instrument or prevent it from shifting in the carton. Styrene pellets cause the instrument damage by generating static electricity and by lodging in the rear panel.

ITECH recommends that you retain the original shipping carton for return shipments and always insure shipments. To ship the unit to ITECH for service or repair:

1. Download the **ITECH maintenance service application** from our website, complete it and place it in the box with the instrument.
2. Place the unit in its original container with appropriate packaging material.

If the original shipping container is unavailable, use a container that will ensure at least 10 cm (4 in.) of compressible packaging material around the entire instrument. Use static-free packaging materials.

3. Secure the container with strong tape or metal bands.

A Appendix

- ◆ Specifications of Red and Black Test Cables
- ◆ Troubleshooting
- ◆ Fuse Replacement

A.1 Specifications of Red and Black Test Cables

ITECH provides you with optional red and black test cables, which are sold individually and you can select for test. For specifications of ITECH test cables and maximum current values, refer to the table below.

Model	Specification	Length	Description
IT-E30110-AB	10A	1m	A pair of red and black test cables with an alligator clip at one end and a banana plug at the other end
IT-E30110-BB	10A	1m	A pair of red and black test cables with banana plugs at both ends
IT-E30110-BY	10A	1m	A pair of red and black test cables with a banana plug at one end and a Y-terminal at the other end
IT-E30312-YY	30A	1.2m	A pair of red and black test cables with Y-terminals at both ends
IT-E30320-YY	30A	2m	A pair of red and black test cables with Y-terminals at both ends
IT-E30615-OO	60A	1.5m	A pair of red and black test cables with round terminals at both ends
IT-E31220-OO	120A	2m	A pair of red and black test cables with round terminals at both ends

Model	Specifica- tion	Length	Description
IT-E32410-OO	240A	1m	A pair of red and black test ca- bles with round terminals at both ends
IT-E32420-OO	240A	2m	A pair of red and black test ca- bles with round terminals at both ends
IT-E33620-OO	360A	2m	A pair of red and black test ca- bles with round terminals at both ends

For maximum current of AWG copper wire, refer to table below.

AWG	8	10	12	14	16	18	20	22	24	26	28
The Maxi- mum Current Value (A)	60	40	30	20	13	10	7	5	3.5	2.5	1.7



Note

- AWG (American Wire Gage), it means X wire (marked on the wire). The table above lists current capacity of single wire at working temperature of 30°C. For reference only.
- Along with temperature, you must also consider voltage drop when selecting wire sizes.

Although the instrument will compensate for the voltage in the wires, it is recommended to minimize the voltage drop as much as possible to prevent excessive power consumption from the instrument and poor dynamic response to load changes. Larger diameter wire sizes will help minimize wire voltage drops. Twisting or bundling wires will help reduce transient voltage drops.

A.2 Troubleshooting

The fault information of this series of instruments is described below.

Term or abbreviation	Description	How to do
MODULE CHECK FAIL	Module detection failed	Re-check after power-off restart. If it still fails to check, please contact ITECH authorized dealer or ITECH technical support.
ECP	Current equalization protection	
HARDWARE FAIL	Hardware fault	
INH LATCH	Disable output, turn off the output.	For details, see 5.11.5 IO–5. INH-Living, Not-Invert.
INH LIVING	Disable output, turn on the output.	
UVP PROT	Undervoltage protection	For details, see 4.5 Protection Function for Power Supply.
OVP PROT	Overvoltage protection	
OCP PROT	Overcurrent protection	
OPP PROT	Over power protection	
UCP PROT	Undercurrent protection	
OTP PROT	Over temperature protection	
SENSE PROT	Sense abnormal protection	
SRVS PROT	Sense reverse protection	
ORVS PROT	Output reverse connection protection	
FIBER MULTI MASTER	Multi-master conflict	When multiple master unit are connected in parallel, multiple Masters are set in System menus. Just set 1 Master, and the other units are Slave.
FIBER EXT UNLOCK	The outer ring of the fiber is not locked.	Fiber multi-master parallel: set the parallel in the System menu in turn. For details, see 5.10

		Set Parallel Operation Mode (Parallel).
FIBER INNER UNLOCK	The inner ring of the fiber is not locked.	Please contact ITECH authorized dealer or ITECH technical support.
Fiber Locking / Networking	Optical fiber parallel error, parallel networking failure	Please contact ITECH authorized dealer or ITECH technical support.
POWER FAIL	Power down	Power on again
CURR SHARE FAIL	Current output unequalization	Check the specifications of the DUT and reconnect the DUT. If the fault still occurs, please contact ITECH authorized dealer or ITECH technical support.
CAP OCP	Capacitor overcurrent	



A.3 Fuse Replacement



Different models of our company product are supplied with different fuse assembly. The way to replace the fuse changes accordingly. The common ways are as follows. Please choose the corresponding way of disassembly and replacement based on the fuse assembly of the actual instrument.

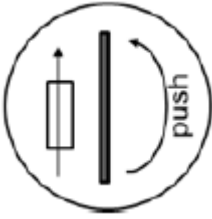
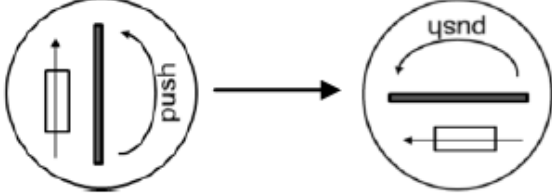
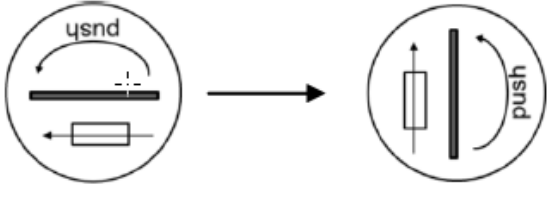

Note

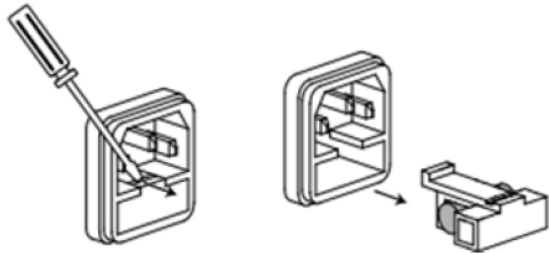
If there are no fuse assembly on the instrument rear panel, it means that you can't replace the fuse by yourself. Please contact the ITECH engineer on the condition of the same malfunction.

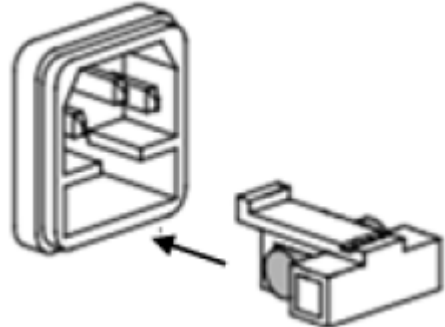
The type of the fuse	The way to replace
	<ol style="list-style-type: none"> Use a screwdriver to push and turn the fuse box anti-clockwise. When turned to 90 degrees, release the screwdriver. Refer to the picture below.  <ol style="list-style-type: none"> The fuse box will bounce up, then you can see the fuse in it. Take out the blown fuse. Please replace with a fuse of the same specification. Refer to the technical specification of the corresponding instrument. When install, put into the fuse box as the picture below. Then use a screwdriver to push and turn the fuse box to 90 degrees clockwise. Refer to the picture below. 
	<p>The power cord jack of the instrument includes the fuse. Please refer to the rear panel introduction of the corresponding instrument for the detailed position. The replacement steps for this type of the fuse are as follows.</p> <ol style="list-style-type: none"> First pull out the power cord, and then take out the fuse block from the power cord jack with a small screwdriver, as shown below.  <ol style="list-style-type: none"> Have a visual inspection of the fuse to see whether it is burnt out; if yes, replace it with another fuse of the same specification. Refer to the corresponding technical specifications for fuse rating.

The type of the fuse	The way to replace
	<p>3. After replacement, mount the fuse block to the original position, as illustrated below.</p> 
	<ol style="list-style-type: none"> 1. Push and turn the fuse box anti-clockwise by hand. When turned to 90 degrees, release the screwdriver. 2. The fuse box will bounce up, then you can see the fuse in it. Take out the blown fuse. 3. Please replace with a fuse of the same specification. Refer to the technical specification of the corresponding instrument. 4. When install, put into the fuse box firstly. Then Push and turn the fuse box to 90 degrees clockwise.

Connect with us

Thank you for purchasing ITECH products. Any questions, pls. feel free to let us know.

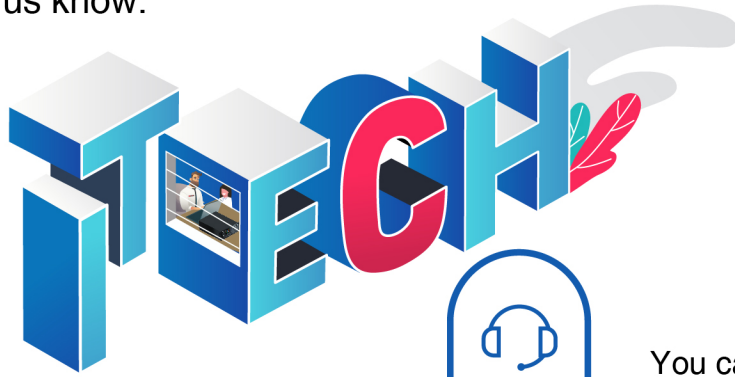

You can chat with us on ITECH website



For more information, pls. visit www.itechate.com



Click and follow ITECH Electronics

